

User's Guide

Volume 2

Measurement and Analysis

Agilent 4155B Semiconductor Parameter Analyzer
Agilent 4156B Precision Semiconductor Parameter Analyzer



Agilent Technologies

Agilent Part No. 04156-90200

Printed in USA January 2000

Edition 4

Legal Notice

The information contained in this document is subject to change without notice.

Copyright © 1997, 2000 Agilent Technologies

This document contains information which is protected by copyright. All rights are reserved. Reproduction, adaptation, or translation without prior written permission is prohibited, except as allowed under the copyright laws.

- **Product Warranty**

Agilent Technologies warrants Agilent Technologies hardware, accessories and supplies against defects in materials and workmanship for the period of one year from the warranty start date specified below. If Agilent Technologies receives notice of such defects during the warranty period, Agilent Technologies will, at its option, either repair or replace products which prove to be defective. Replacement products may be either new or like-new.

Warranty service of this product will be performed at Agilent Technologies. Buyer shall prepay shipping charges to Agilent Technologies and Agilent Technologies shall pay shipping charges to return the product to Buyer. However, Buyer shall pay all shipping charges, duties, and taxes for products returned to Agilent Technologies from another country.

Agilent Technologies does not warrant that the operation of Agilent Technologies products will be uninterrupted or error free. If Agilent Technologies is unable, within a reasonable time, to repair or replace any product to a condition as warranted, customer will be entitled to a refund of the purchase price upon prompt return of the product.

The Agilent Technologies products may contain remanufactured parts equivalent to new in performance or may have been subject to incidental use.

The warranty period begins on the date of delivery or on the date of installation if installed by Agilent Technologies. If customer schedules or delays Agilent Technologies installation more than 30 days after delivery, warranty begins on the 31st day from delivery.

Warranty does not apply to defects resulting from (a) improper or inadequate maintenance or calibration, (b) software, interfacing, parts or supplies not supplied by Agilent Technologies, (c) unauthorized modification or misuse, (d) operation outside of the published environmental specifications for the product, or (e) improper site preparation or maintenance.

To the extent allowed by local law, the above warranties are exclusive and no other warranty or condition, whether written or oral, is expressed or implied and Agilent Technologies specifically disclaims any implied warranties or conditions of merchantability, satisfactory quality, and fitness for a particular purpose.

Agilent Technologies will be liable for damage to tangible property per incident up to the greater of \$300,000 or the actual amount paid for the product that is the subject of the claim, and for damages for bodily injury or death, to the extent that all such damages are determined by a court of competent jurisdiction to have been directly caused by a defective Agilent Technologies product.

To the extent allowed by local law, the remedies in this warranty statement are customer's sole and exclusive remedies. Except as indicated above, in no event will Agilent Technologies or its suppliers be liable for loss of date or for direct, special, incidental, consequential (including lost profit or date), or other damage, whether based in contract, tort, or otherwise.

For consumer transactions in Australia and New Zealand: the warranty terms contained in this statement, except to the extent lawfully permitted, do not exclude, restrict or modify and are in addition to the mandatory statutory rights applicable to the sale of this product to you.

- **Assistance**

Product maintenance agreements and other customer assistance agreements are available for Agilent Technologies products.

For any assistance, contact your nearest Agilent Technologies Sales Office.

- **Certification**

Agilent Technologies, Inc. certifies that this product met its published specifications at the time of shipment from the factory. Agilent Technologies further certifies that its calibration measurements are traceable to the National Institute of Standards and Technology (NIST), to the extent allowed by the Institute's calibration facility, and to the calibration facilities of other International Standards Organization members.

- **Safety Summary**

The following general safety precautions must be observed during all phases of operation, service, and repair of this instrument. Failure to comply with these precautions or with specific warnings elsewhere in this manual may impair the protections provided by the equipment. In addition, it violates safety standards of design, manufacture, and intended use of the instrument. Agilent Technologies, Inc. assumes no liability for customer's failure to comply with these requirements.

NOTE

Agilent 4155B/4156B/41501B comply with INSTALLATION CATEGORY II for mains input and INSTALLATION CATEGORY I for measurement input terminals, and POLLUTION DEGREE 2 defined in IEC 1010-1.

Agilent 4155B/4156B/41501B are INDOOR USE products.

NOTE

LEDs in Agilent 4155B/4156B/41501B are Class 1 in accordance with IEC 825-1. CLASS 1 LED PRODUCT.

- *GROUND THE INSTRUMENT*

This is Safety Class I instrument. To minimize shock hazard, the instrument chassis and cabinet must be connected to an electrical ground. The power terminal and the power cable must meet International Electrotechnical Commission (IEC) safety standards.

- *DO NOT OPERATE IN AN EXPLOSIVE ATMOSPHERE*

Do not operate the instrument in the presence of flammable gases or fumes. Operation of any electrical instrument in such an environment constitutes a definite safety hazard.

- *KEEP AWAY FROM LIVE CIRCUITS*

Operation personnel must not remove instrument covers. Component replacement and internal adjustments must be made by qualified maintenance personnel. Do not replace components with power cable connected. Under certain conditions, dangerous voltages may exist even with the power cable removed. To avoid injuries, always disconnect power and discharge circuits before touching them.

- *DO NOT SERVICE OR ADJUST ALONE*

Do not attempt internal service or adjustment unless another person, capable of rendering first aid and resuscitation, is present.

- *DO NOT SUBSTITUTE PARTS OR MODIFY INSTRUMENT*

Because of the danger of introducing additional hazards, do not install substitute parts or perform any unauthorized modification to the instrument. Return the instrument to a Agilent Technologies Sales and Service Office for services and repair to ensure that safety features are maintained.

- *DANGEROUS PROCEDURE WARNINGS*

Warnings, such as example below, precede potentially dangerous procedures throughout this manual. Instructions contained in the warnings must be followed.

WARNING

Dangerous Voltage, capable of causing death, are present in this instrument. Use extreme caution when handling, testing, and adjusting.

- **Safety Symbols**

The general definitions of safety symbols used on equipment or in manuals are listed below.



Instruction manual symbol: the product will be marked with this symbol when it is necessary for the user to refer to the instruction manual in order to protect against damage to the instrument.



Indicates dangerous voltage and potential for electrical shock. Do not touch terminals that have this symbol when instrument is on.



Protective conductor terminal. For protection against electrical shock in case of a fault. Used with field wiring terminals to indicate the terminal which must be connected to ground before operating equipment.



Frame or chassis terminal. A connection to the frame (chassis) of the equipment which normally includes all exposed metal structures.



Indicates earth (ground) terminal.



Alternating current.



Direct current.



ON (Supply).



OFF (Supply).



STANDBY (Supply).

CAT 1

Means INSTALLATION CATEGORY I. Measurement terminals on the rear panel comply with INSTALLATION CATEGORY I.

WARNING

The warning sign denotes a hazard. It calls attention to a procedure, practice, condition or the like, which, if not correctly performed or adhered to, could result in injury or death to personal.

CAUTION

The caution sign denotes a hazard. It calls attention to an operating procedure, practice, condition or the like, which, if not correctly performed or adhered to, could result in damage to or destruction of part or all of the product.

- **Herstellerbescheinigung**

GEÄUSCHEMISSION

Lpa < 70 dB

am Arbeitsplatz

normaler Betrieb

nach DIN 45635 T. 19

- **Manufacturer's Declaration**

ACOUSTIC NOISE EMISSION

Lpa < 70dB

operator position

normal operation

per ISO 7779

Printing History

Edition 1:	August 1997
Edition 2:	September 1997
Edition 3:	October 1998
Edition 4:	January 2000

In This Manual

This manual provides information for all parts and functions of Agilent 4155B/4156B, and consists of the following chapters:

- **Measurement Units**
This chapter provides information about the measurement units.
- **Measurement Mode**
This chapter provides information about sweep and sampling measurements.
- **Measurement Functions**
This chapter provides information about the measurement functions.
- **Making a Measurement**
This chapter describes how to perform measurements.
- **Analyzing Measurement Results**
This chapter describes how to analyze measurement results manually and automatically.
- **Page Organization**
This chapter provides information about each user interface page that is displayed on the instrument screen.
- **Data Variable and Analysis Function**
This chapter provides information about data variables and analysis functions.
- **If You Have A Problem**
This chapter provides problem-solving information that you may encounter.

Text Conventions

The following text conventions are used in this manual:

- | | |
|---------------|--|
| Screen Text | Represents text that appears on screen of the 4155B/4156B. |
| <i>Italic</i> | Refers to a related document, or is used for emphasis. |

Contents

1. Measurement Units

Ground Unit (GNDU)	1-3
Source/Monitor Unit (SMU)	1-4
Voltage Source Unit (VSU)	1-16
Voltage Monitor Unit (VMU)	1-17
Pulse Generator Unit (PGU)	1-20

2. Measurement Mode

Sweep Measurement Mode	2-3
Basic Sweep Measurement	2-4
Subordinate Sweep Measurement	2-7
Synchronous Sweep Measurement	2-9
Pulse Sweep Measurement	2-11
Sampling Measurement Mode	2-14
Available Units	2-14
Sampling Interval and Measurement Time	2-15
Sampling Measurement Data	2-18
Sampling Completion	2-20
Source Output Sequence and Time Origin	2-22
Linear Sampling Measurement	2-24
Thinned-out Sampling Measurement	2-27
Logarithmic Sampling Measurement	2-30

3. Measurement Functions

Stress Force Function	3-3
Stress Output Channels	3-4
Stress Mode	3-6
Stress Force Sequence	3-7
Stress Stop Function at Abnormal Status	3-10

Contents

SMU/PG Selector Control	3-11
Knob Sweep Function	3-13
Features of Knob Sweep Function	3-15
KNOB SWEEP screen	3-20
Operation States	3-30
Idle State	3-30
Measurement State	3-31
Stress Force State	3-31
Standby State	3-32
Changing among Operation States	3-36
Output Sequence	3-38
Sequential Mode	3-39
Simultaneous Mode	3-42
Trigger Function	3-44
Externally Triggered Sampling or Sweep Measurement	3-46
Triggering an External Instrument	3-47
R-BOX Control	3-51
Resistance Value	3-51
Setups	3-52
Circuit Diagram	3-53
Connections	3-54
Measurement Ranging Mode	3-56
Auto Ranging	3-57
Limited Auto Ranging	3-58
Compliance Range	3-59
Fixed Range	3-59
Compliance	3-60
Voltage and Current Compliance	3-60
Power Compliance	3-65

Contents

Integration Time	3-67
Short	3-67
Medium	3-68
Long	3-68
SMU Filter	3-69
Zero Offset Cancel	3-70
Setup and Restrictions	3-72
Measuring Offset Data	3-72
Performing Offset Cancel	3-72
4. Making a Measurement	
Connection to Device Under Test (DUT)	4-3
To Mount a DUT on Test Fixture	4-4
To Make Connections to Reduce Leakage Current	4-6
To Make Connections to Measure Low Resistance (For 4156B Only)	4-8
Sweep Measurements	4-10
To Define Sweep Measurement Units	4-12
To Set up Primary Sweep Source	4-14
To Set up Secondary Sweep Source	4-16
To Set up Synchronous Sweep Source	4-18
To Set up Constant Output	4-20
To Set up SMU Pulsed Output	4-21
To Set up PGU Pulsed Output	4-23
To Output Same Value Before and After Measurements	4-25
To Define a User Function	4-26
To Set up Graphical Display of Measurement Results	4-27
To Set up List Display of Measurement Results	4-29
To Execute Calibration	4-30
To Cancel Zero Offset	4-30
To Execute or Stop Measurement	4-31

Contents

To Control R-Box	4-32
Knob Sweep Measurements	4-34
To Execute Knob Sweep Measurement	4-35
To Stop Knob Sweep Measurement	4-38
Sampling Measurements	4-39
To Define Sampling Measurement Units	4-41
To Set up Sampling Parameters	4-43
To Set up Constant Output	4-45
To Define Measurement Stop Conditions	4-46
Stress Force	4-48
To Set up Stress Source Channels	4-50
To Set up Stress Condition/Timing	4-52
To Set up AC (Pulse) Stress	4-54
To Set up DC Stress	4-56
To Force Stress	4-57
To Control Selector for Switching SMU and PGU	4-59
5. Analyzing Measurement Results	
Manual Analysis	5-3
To Specify a Measurement Point on Curve	5-4
To Specify between Measurement Points on Curve	5-6
To Display or Move Cursor	5-8
To Adjust Display Range to Measurement Curve Automatically	5-9
To Zoom the Display Range	5-9
To Center Display at Cursor Location	5-10
To Draw Line through Two Specified Points	5-10
To Draw Line through Specified Point with Specified Gradient	5-12
To Draw Tangent to Specified Point of Measurement Curve	5-14
To Draw Regression Line for Specified Region	5-16
To Display and Select a Line	5-18

Contents

To Display Grid on the Graph	5-18
To Change Data Variable on Graph	5-19
To Change Range of X or Y Axis Scale	5-20
To Change Variable Assigned to X, Y1, or Y2 Axis	5-21
To Overlay an Internal Memory Measurement Curve onto Plotting Area ...	5-22
To Scroll the LIST screen	5-24
To Display or Move Marker on LIST screen	5-25
To Change Variables of LIST screen	5-26
Automatic Analysis	5-27
To Draw Line by Specifying Two Points	5-28
To Draw Line by Specifying Gradient and One Point	5-30
To Draw Tangent to Specified Measurement Point	5-32
To Draw Regression Line by Specifying Two Points	5-34
To Display Marker at Specified Point	5-37

6. Page Organization

Screen Structure	6-3
CHANNELS Screen Group	6-5
CHANNELS: CHANNEL DEFINITION screen	6-6
CHANNELS: USER FUNCTION DEFINITION screen	6-12
CHANNELS: USER VARIABLE DEFINITION screen	6-14
MEASURE Screen Group	6-16
MEASURE: SWEEP SETUP screen	6-17
MEASURE: SAMPLING SETUP screen	6-22
MEASURE: PGU SETUP screen	6-26
MEASURE: MEASURE SETUP screen	6-29
MEASURE: OUTPUT SEQUENCE screen	6-32
DISPLAY Screen Group	6-35
DISPLAY: DISPLAY SETUP screen for graphic results	6-37
DISPLAY: DISPLAY SETUP screen for list results	6-39

Contents

DISPLAY: ANALYSIS SETUP screen	6-41
GRAPH/LIST Screen Group	6-47
On the GRAPHICS result screen	6-47
On the LIST result screen	6-47
GRAPH/LIST: GRAPHICS screen	6-48
GRAPH/LIST: LIST screen	6-63
STRESS Screen Group	6-75
STRESS: CHANNEL DEFINITION screen	6-76
STRESS: STRESS SETUP screen	6-80
STRESS: STRESS FORCE screen	6-84
Screen Operation	6-86
Status Indicators	6-91
7. Data Variable and Analysis Function	
Data Variable	7-3
Data Variable for Output or Measurement Data	7-3
User Function	7-5
User Variable	7-6
Syntax of Data Variable Name	7-7
Expression	7-8
Reference: Built-in Function	7-12
ABS	7-13
AT	7-13
AVG	7-13
COND	7-14
DELTA	7-15
DIFF	7-16
EXP	7-17
INTEG	7-17

Contents

LGT	7-18
LOG	7-18
MAVG	7-19
MAX	7-20
MIN	7-20
SQRT	7-20
Read Out Function	7-21
@CX	7-22
@CY	7-22
@CY1	7-22
@CY2	7-22
@IX	7-23
@IY	7-23
@IY1	7-24
@IY2	7-24
@L1CO	7-25
@L1G	7-25
@L1G1	7-26
@L1G2	7-27
@L1X	7-28
@L1Y	7-28
@L1Y1	7-28
@L1Y2	7-28
@L2CO	7-28
@L2G	7-29
@L2G1	7-30
@L2G2	7-31
@L2X	7-32
@L2Y	7-32
@L2Y1	7-32
@L2Y2	7-32

Contents

@MI	7-32
@MX	7-33
@MY	7-33
@MY1	7-33
@MY2	7-33
Analysis Function	7-34
Marker on the GRAPH/LIST: GRAPHICS page	7-35
Marker on the GRAPH/LIST: LIST page	7-37
Cursor	7-39
Line Drawing	7-40
Scaling Functions	7-42
Overlay Display Function	7-43
Automatic Analysis Function	7-44
8. If You Have A Problem	
When You Make A Measurement	8-4
If Measured Value Oscillates when Measuring High-Frequency Devices	8-5
If Measured Value Oscillates when Measuring Negative Resistance	8-6
If Noise Affects the Measured Values	8-7
If Measured Voltage has some Error when Forcing a Large Current	8-8
If Large Current Causes High Temperature (Thermal Drift)	8-8
If Measurement Takes More Time than Specified	8-9
If Measurement Damages the Device under Test	8-10
If You Get Unexpected Data when Performing Sampling Measurement	8-12
If Errors Occur	8-13
If Errors Occur when You Perform Self-calibration or Diagnostics	8-14
If Errors Occur when You Operate the 4155B/4156B	8-20
If a Measurement Data Status is Displayed	8-38

1 Measurement Units

Measurement Units

This chapter explains basic output and measurement functions of each measurement unit. For the following units, a simplified circuit diagram is shown, and where applicable, the output and measurement ranges are provided.

- “Ground Unit (GNDU)”
- “Source/Monitor Unit (SMU)”
- “Voltage Source Unit (VSU)”
- “Voltage Monitor Unit (VMU)”
- “Pulse Generator Unit (PGU)”

Ground Unit (GNDU)

The ground unit (GNDU) is in Agilent 41501A/B (SMU and pulse generator expander). The GNDU is a 0 V constant source that provides a measurement ground reference, and can sink up to ± 1.6 A. Figure 1-1 shows a simplified GNDU circuit diagram.

Figure 1-1 Simplified GNDU Circuit Diagram

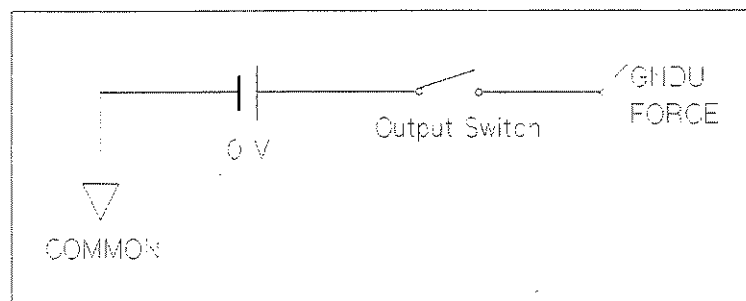

UG002001

Source/Monitor Unit (SMU)

The source/monitor unit (SMU) has the following three modes:

- voltage source and current monitor mode (V source and I monitor mode)
- current source and voltage monitor mode (I source and V monitor mode)
- source common mode

SMU can output constant or pulsed source. (Only one SMU can be set to pulsed source.)

Figure 1-2 shows a simplified SMU circuit diagram.

Figure 1-2

Simplified SMU Circuit Diagram

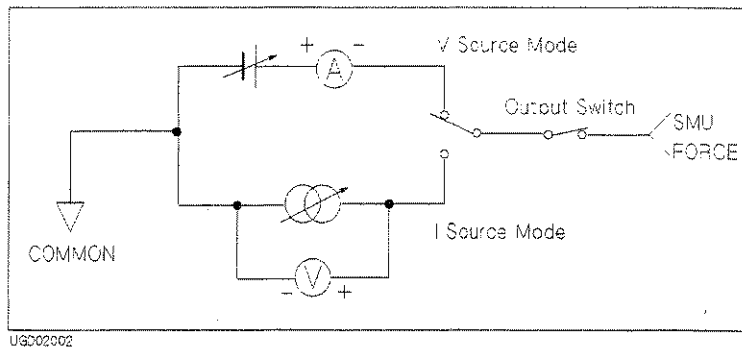

Measurement Units Source/Monitor Unit (SMU)

Three types of SMUs are available:

- HRSMU (high resolution SMU)
 - Force and measure: up to ± 100 V or ± 100 mA.
 - Maximum output power: 2 W.
 - Minimum current measurement range: 10 pA with 1 fA resolution.
 - Only the 4156B has HRSMUs. The 4156B has four HRSMUs.
- MPSMU (medium power SMU)
 - Force and measure: up to ± 100 V or ± 100 mA.
 - Maximum output power: 2 W.
 - The 4155B has four MPSMUs, and the 41501A/B can be equipped with either two MPSMUs or one HPSMU.
- HPSMU (high power SMU)
 - Force and measure: up to ± 200 V or ± 1 A.
 - Maximum output power: 20 W.
 - Only the 41501A/B has HPSMU. The 41501A/B can be equipped with either two MPSMUs or one HPSMU.

HPSMUs and HRSMUs can be connected to test devices by Kelvin connection.

Each SMU has a compliance feature that limits output voltage or current to prevent damage to your devices. When the SMU forces voltage, you can specify I compliance. When the SMU forces current, you can specify V compliance.

For details about the compliance setting range and resolution, see “Compliance” in Chapter 3.

The following figures and tables show the output and measurement ranges of each SMU type.

Measurement Units
Source/Monitor Unit (SMU)

Figure 1-3

HRSMU Output and Measurement Ranges

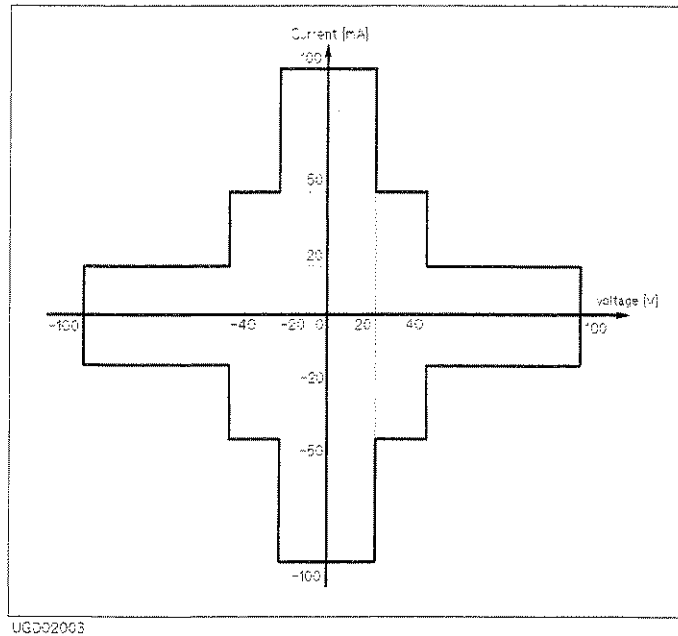

UG002003

Table 1-1

HRSMU Output Voltage Ranges and Resolutions

Range	Output Value	Output Resolution	Current Compliance Range
2 V	$0 \leq V \leq 2 \text{ V}$	100 μV	$\pm 100 \text{ mA}$
20 V	$0 \leq V \leq 20 \text{ V}$	1 mV	$\pm 100 \text{ mA}$
40 V	$0 \leq V \leq 40 \text{ V}$	2 mV	$\pm 50 \text{ mA}$
100 V	$0 \leq V \leq 100 \text{ V}$	5 mV	$\pm 20 \text{ mA}$

Table 1-2 HRSMU Measurement Voltage Values and Resolutions

Range	Measurement Value ^a	Measurement Resolutions ^b			
		Integration Time			High Speed Sampling Measurement ^c
		1PLC or Longer	640 μ s to 1.92 ms	80 μ s to 560 μ s	
2 V	$0 \leq V \leq 2.2$ V	2 μ V	20 μ V	200 μ V	2 mV
20 V	$0 \leq V \leq 22$ V	20 μ V	200 μ V	2 mV	20 mV
40 V	$0 \leq V \leq 44$ V	40 μ V	400 μ V	4 mV	40 mV
100 V	$0 \leq V \leq 100$ V	100 μ V	1 mV	10 mV	100 mV

- a. This column is applied to the auto ranging or the limited auto ranging. For fixed ranging, maximum measurement value is **Range** column value.
- b. Measurement resolution depends on the integration time setting. For Knob sweep measurement, see the column of Integration Time 80 μ s to 560 μ s.
- c. This column is applied to the sampling measurement that *initial interval* is set to 480 μ s or shorter.

Table 1-3 HRSMU Output Current Ranges and Resolutions

Range	Output Value	Output Resolution	Voltage Compliance Range
10 pA	$0 \leq I \leq 10$ pA	10 fA	± 100 V
100 pA	$0 \leq I \leq 100$ pA	10 fA	± 100 V
1 nA	$0 \leq I \leq 1$ nA	100 fA	± 100 V
10 nA	$0 \leq I \leq 10$ nA	1 pA	± 100 V
100 nA	$0 \leq I \leq 100$ nA	10 pA	± 100 V
1 μ A	$0 \leq I \leq 1$ μ A	100 pA	± 100 V
10 μ A	$0 \leq I \leq 10$ μ A	1 nA	± 100 V
100 μ A	$0 \leq I \leq 100$ μ A	10 nA	± 100 V
1 mA	$0 \leq I \leq 1$ mA	100 nA	± 100 V
10 mA	$0 \leq I \leq 10$ mA	1 μ A	± 100 V
100 mA	$0 \leq I \leq 20$ mA	10 μ A	± 100 V
	20 mA < $ I \leq 50$ mA	10 μ A	± 40 V
	50 mA < $ I \leq 100$ mA	10 μ A	± 20 V

Measurement Units
Source/Monitor Unit (SMU)

Table 1-4 HRSMU Measurement Current Values and Resolutions

Range	Measurement Value ^a	Measurement Resolutions ^b			
		Integration Time			High Speed Sampling Measurement ^c
		1PLC or Longer	640 μ s to 1.92 ms	80 μ s to 560 μ s	
10 pA	$0 \leq I \leq 10.5 \text{ pA}$	1 fA	1 fA	1 fA	10 fA
100 pA	$0 \leq I \leq 115 \text{ pA}$	1 fA	1 fA	10 fA	100 fA
1 nA	$0 \leq I \leq 1.15 \text{ nA}$	10 fA	10 fA	100 fA	1 pA
10 nA	$0 \leq I \leq 11.5 \text{ nA}$	10 fA	100 fA	1 pA	10 pA
100 nA	$0 \leq I \leq 115 \text{ nA}$	100 fA	1 pA	10 pA	100 pA
1 μ A	$0 \leq I \leq 1.15 \text{ } \mu\text{A}$	1 pA	10 pA	100 pA	1 nA
10 μ A	$0 \leq I \leq 11.5 \text{ } \mu\text{A}$	10 pA	100 pA	1 nA	10 nA
100 μ A	$0 \leq I \leq 115 \text{ } \mu\text{A}$	100 pA	1 nA	10 nA	100 nA
1 mA	$0 \leq I \leq 1.15 \text{ mA}$	1 nA	10 nA	100 nA	1 μ A
10 mA	$0 \leq I \leq 11.5 \text{ mA}$	10 nA	100 nA	1 μ A	10 μ A
100 mA	$0 \leq I \leq 100 \text{ mA}$	100 nA	1 μ A	10 μ A	100 μ A

- a. This column is applied to the auto ranging or the limited auto ranging. For fixed ranging, maximum measurement value is **Range** column value.
- b. Measurement resolution depends on the integration time setting. For Knob sweep measurement, see the column of Integration Time 80 μ s to 560 μ s.
- c. This column is applied to the sampling measurement that *initial interval* is set to 480 μ s or shorter.

Figure 1-4 MPSMU Output and Measurement Ranges

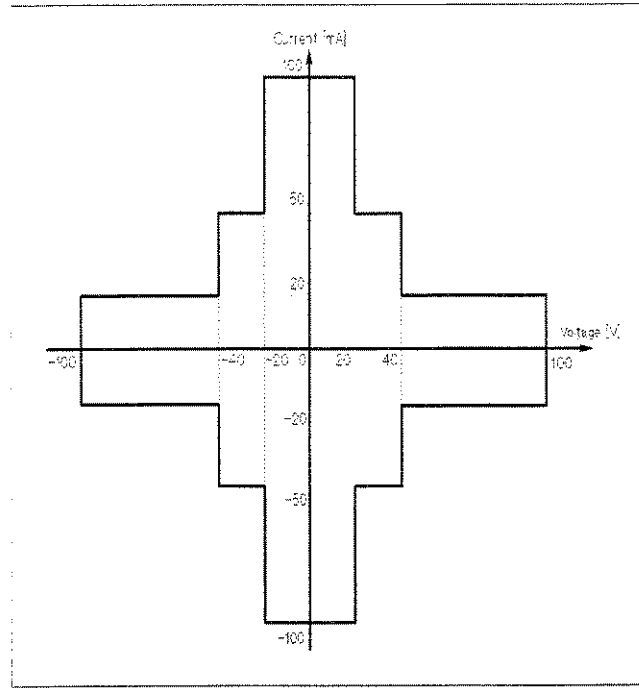

UGD02004

Table 1-5 MPSMU Output Voltage Ranges and Resolutions

Range	Output Value	Output Resolution	Current Compliance Range
2 V	$0 \leq V \leq 2 \text{ V}$	100 μV	$\pm 100 \text{ mA}$
20 V	$0 \leq V \leq 20 \text{ V}$	1 mV	$\pm 100 \text{ mA}$
40 V	$0 \leq V \leq 40 \text{ V}$	2 mV	$\pm 50 \text{ mA}$
100 V	$0 \leq V \leq 100 \text{ V}$	5 mV	$\pm 20 \text{ mA}$

Measurement Units
Source/Monitor Unit (SMU)

Table 1-6 MPSMU Measurement Voltage Values and Resolutions

Range	Measurement Value ^a	Measurement Resolutions ^b			
		Integration Time			High Speed Sampling Measurement ^c
		1PLC or Longer	640 μ s to 1.92 ms	80 μ s to 560 μ s	
2 V	$0 \leq V \leq 2.2$ V	2 μ V	20 μ V	200 μ V	2 mV
20 V	$0 \leq V \leq 22$ V	20 μ V	200 μ V	2 mV	20 mV
40 V	$0 \leq V \leq 44$ V	40 μ V	400 μ V	4 mV	40 mV
100 V	$0 \leq V \leq 100$ V	100 μ V	1 mV	10 mV	100 mV

- a. This column is applied to the auto ranging or the limited auto ranging. For fixed ranging, maximum measurement value is **Range** column value.
- b. Measurement resolution depends on the integration time setting. For Knob sweep measurement, see the column of Integration Time 80 μ s to 560 μ s.
- c. This column is applied to the sampling measurement that *initial interval* is set to 480 μ s or shorter.

Table 1-7 MPSMU Output Current Ranges and Resolutions

Range	Output Value	Output Resolution	Voltage Compliance Range
1 nA	$0 \leq I \leq 1$ nA	100 fA	± 100 V
10 nA	$0 \leq I \leq 10$ nA	1 pA	± 100 V
100 nA	$0 \leq I \leq 100$ nA	10 pA	± 100 V
1 μ A	$0 \leq I \leq 1$ μ A	100 pA	± 100 V
10 μ A	$0 \leq I \leq 10$ μ A	1 nA	± 100 V
100 μ A	$0 \leq I \leq 100$ μ A	10 nA	± 100 V
1 mA	$0 \leq I \leq 1$ mA	100 nA	± 100 V
10 mA	$0 \leq I \leq 10$ mA	1 μ A	± 100 V
100 mA	$0 \leq I \leq 20$ mA	10 μ A	± 100 V
	20 mA $< I \leq 50$ mA	10 μ A	± 40 V
	50 mA $< I \leq 100$ mA	10 μ A	± 20 V

Table 1-8 MPSMU Measurement Current Values and Resolutions

Range	Measurement Value ^a	Measurement Resolutions ^b			
		Integration Time			High Speed Sampling Measurement ^c
		1PLC or Longer	640 μ s to 1.92 ms	80 μ s to 560 μ s	
1 nA	$0 \leq I \leq 1.15$ nA	10 fA	10 fA	100 fA	1 pA
10 nA	$0 \leq I \leq 11.5$ nA	10 fA	100 fA	1 pA	10 pA
100 nA	$0 \leq I \leq 115$ nA	100 fA	1 pA	10 pA	100 pA
1 μ A	$0 \leq I \leq 1.15$ μ A	1 pA	10 pA	100 pA	1 nA
10 μ A	$0 \leq I \leq 11.5$ μ A	10 pA	100 pA	1 nA	10 nA
100 μ A	$0 \leq I \leq 115$ μ A	100 pA	1 nA	10 nA	100 nA
1 mA	$0 \leq I \leq 1.15$ mA	1 nA	10 nA	100 nA	1 μ A
10 mA	$0 \leq I \leq 11.5$ mA	10 nA	100 nA	1 μ A	10 μ A
100 mA	$0 \leq I \leq 100$ mA	100 nA	1 μ A	10 μ A	100 μ A

- a. This column is applied to the auto ranging or the limited auto ranging. For fixed ranging, maximum measurement value is **Range** column value.
- b. Measurement resolution depends on the integration time setting. For Knob sweep measurement, see the column of Integration Time 80 μ s to 560 μ s.
- c. This column is applied to the sampling measurement that *initial interval* is set to 480 μ s or shorter.

Measurement Units
Source/Monitor Unit (SMU)

Figure 1-5

HPSMU Output and Measurement Ranges

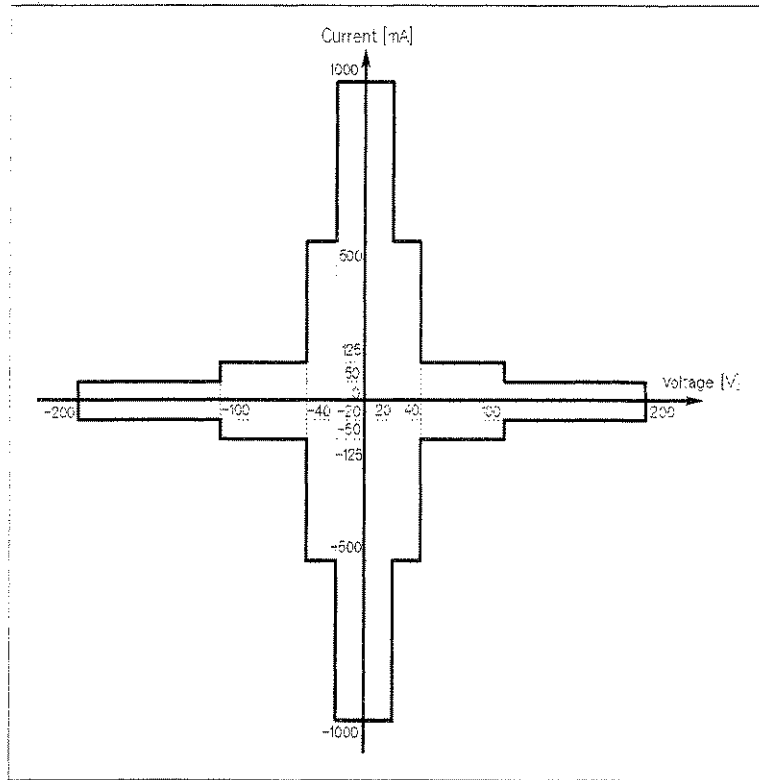

UGD02005

Table 1-9

HPSMU Output Voltage Ranges and Resolutions

Range	Output Value	Output Resolution	Current Compliance Range
2 V	$0 \leq V \leq 2 \text{ V}$	100 μV	$\pm 1000 \text{ mA}$
20 V	$0 \leq V \leq 20 \text{ V}$	1 mV	$\pm 1000 \text{ mA}$
40 V	$0 \leq V \leq 40 \text{ V}$	2 mV	$\pm 500 \text{ mA}$
100 V	$0 \leq V \leq 100 \text{ V}$	5 mV	$\pm 125 \text{ mA}$
200 V	$0 \leq V \leq 200 \text{ V}$	10 mV	$\pm 50 \text{ mA}$

Table 1-10 HPSMU Measurement Voltage Values and Resolutions

Range	Measurement Value ^a	Measurement Resolutions ^b			
		Integration Time			High Speed Sampling Measurement ^c
		IPLC or Longer	640 μ s to 1.92 ms	80 μ s to 560 μ s	
2 V	$0 \leq V \leq 2.2$ V	2 μ V	20 μ V	200 μ V	2 mV
20 V	$0 \leq V \leq 22$ V	20 μ V	200 μ V	2 mV	20 mV
40 V	$0 \leq V \leq 44$ V	40 μ V	400 μ V	4 mV	40 mV
100 V	$0 \leq V \leq 110$ V	100 μ V	1 mV	10 mV	100 mV
200 V	$0 \leq V \leq 200$ V	200 μ V	2 mV	20 mV	200 mV

- This column is applied to the auto ranging or the limited auto ranging. For fixed ranging, maximum measurement value is **Range** column value.
- Measurement resolution depends on the integration time setting. For Knob sweep measurement, see the column of Integration Time 80 μ s to 560 μ s.
- This column is applied to the sampling measurement that *initial interval* is set to 480 μ s or shorter.

Table 1-11 HPSMU Output Current Ranges and Resolutions

Range	Output Value	Output Resolution	Voltage Compliance Range
1 nA	$0 \leq I \leq 1$ nA	100 fA	± 200 V
10 nA	$0 \leq I \leq 10$ nA	1 pA	± 200 V
100 nA	$0 \leq I \leq 100$ nA	10 pA	± 200 V
1 μ A	$0 \leq I \leq 1$ μ A	100 pA	± 200 V
10 μ A	$0 \leq I \leq 10$ μ A	1 nA	± 200 V
100 μ A	$0 \leq I \leq 100$ μ A	10 nA	± 200 V
1 mA	$0 \leq I \leq 1$ mA	100 nA	± 200 V
10 mA	$0 \leq I \leq 10$ mA	1 μ A	± 200 V
100 mA	$0 \leq I \leq 50$ mA	10 μ A	± 200 V
	50 mA < $ I \leq 100$ mA	10 μ A	± 100 V
1 A	$0 \leq I \leq 50$ mA	100 μ A	± 200 V
	50 mA < $ I \leq 125$ mA	100 μ A	± 100 V
	125 mA < $ I \leq 500$ mA	100 μ A	± 40 V
	500 mA < $ I \leq 1$ A	100 μ A	± 20 V

Measurement Units
Source/Monitor Unit (SMU)

Table 1-12 HPSMU Measurement Current Values and Resolutions

Range	Measurement Value ^a	Measurement Resolutions ^b			
		Integration Time			High Speed Sampling Measurement ^c
		IPLC or Longer	640 μs to 1.92 ms	80 μs to 560 μs	
1 nA	$0 \leq I \leq 1.15 \text{ nA}$	10 fA	10 fA	100 fA	1 pA
10 nA	$0 \leq I \leq 11.5 \text{ nA}$	10 fA	100 fA	1 pA	10 pA
100 nA	$0 \leq I \leq 115 \text{ nA}$	100 fA	1 pA	10 pA	100 pA
1 μA	$0 \leq I \leq 1.15 \text{ μA}$	1 pA	10 pA	100 pA	1 nA
10 μA	$0 \leq I \leq 11.5 \text{ μA}$	10 pA	100 pA	1 nA	10 nA
100 μA	$0 \leq I \leq 115 \text{ μA}$	100 pA	1 nA	10 nA	100 nA
1 mA	$0 \leq I \leq 1.15 \text{ mA}$	1 nA	10 nA	100 nA	1 μA
10 mA	$0 \leq I \leq 11.5 \text{ mA}$	10 nA	100 nA	1 μA	10 μA
100 mA	$0 \leq I \leq 50 \text{ mA}$	100 nA	1 μA	10 μA	100 μA
	$50 \text{ mA} < I \leq 115 \text{ mA}$	100 nA	1 μA	10 μA	100 μA
1 A	$0 \leq I \leq 1 \text{ A}$	1 μA	10 μA	100 μA	1 mA

- This column is applied to the auto ranging or the limited auto ranging. For fixed ranging, maximum measurement value is **Range** column value.
- Measurement resolution depends on the integration time setting. For Knob sweep measurement, see the column of Integration Time 80 μs to 560 μs.
- This column is applied to the sampling measurement that *initial interval* is set to 480 μs or shorter.

When SMU is pulsed source, set pulse parameters in following ranges:

Pulse width 0.5 ms to 100 ms, 100 μs resolution

Pulse period 5 ms to 1 s, 100 μs resolution

where pulse period ≥ pulse width + 4 ms

Be aware that if any of following are true, pulsed SMU channel may not output the pulse period and pulse width you specified:

- Measurement range differs from compliance range (lowest range that includes compliance).
- Ranging mode is set to auto range or limited auto range.
- Multi-channel measurement is set.

NOTE

Compliance Range for Pulsed SMU

If you use an SMU as a pulsed source, the compliance setting range is as follows:

current compliance

For SMU used as pulsed voltage source, you can set current compliance as follows:

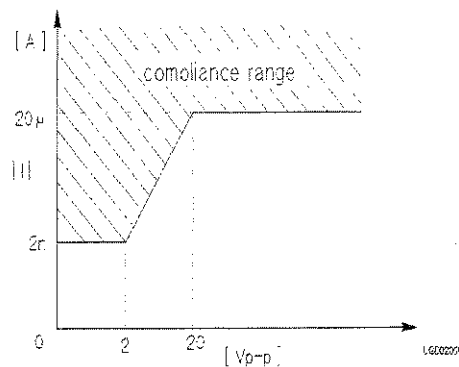

$0 < V_{p-p} < 2 \text{ V}$	$ I > 2 \text{ nA}$
$2 < V_{p-p} < 20 \text{ V}$	$ I > 1.11\text{E-}6 \times V_{p-p} - 2.22\text{E-}6$
$20 < V_{p-p} $	$ I > 20 \text{ }\mu\text{A}$

voltage compliance

If you use SMU as pulse current source, you can set voltage compliance as follows:

- When $|I| \leq 10 \text{ }\mu\text{A}$, voltage compliance must be 2 V or less.
- When $|I| > 10 \text{ }\mu\text{A}$, voltage compliance ranges are same as in tables on previous pages.

If SMU is pulsed *constant* source, I is peak or base current, whichever has larger absolute value.

If SMU is pulsed *sweep* source, I is start or stop value, whichever has larger absolute value.

Voltage Source Unit (VSU)

Figure 1-6 shows a simplified voltage source unit (VSU) circuit diagram.

Figure 1-6

Simplified VSU Circuit Diagram

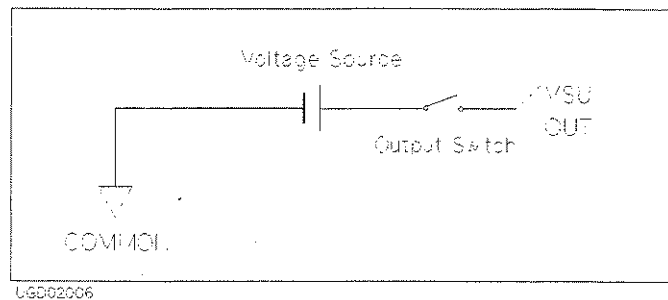

- VSU can force up to ± 20 V.
- Only range available is 20 V range with 1 mV resolution, so output range is automatically set to 20 V.
- Current compliance is automatically set to ± 100 mA.

Voltage Monitor Unit (VMU)

Voltage monitor unit (VMU) has two measurement modes: grounded or differential. Grounded mode uses one VMU. Differential mode uses two VMUs.

Figure 1-7 shows a simplified VMU circuit diagram.

Figure 1-7

Simplified VMU Circuit Diagram

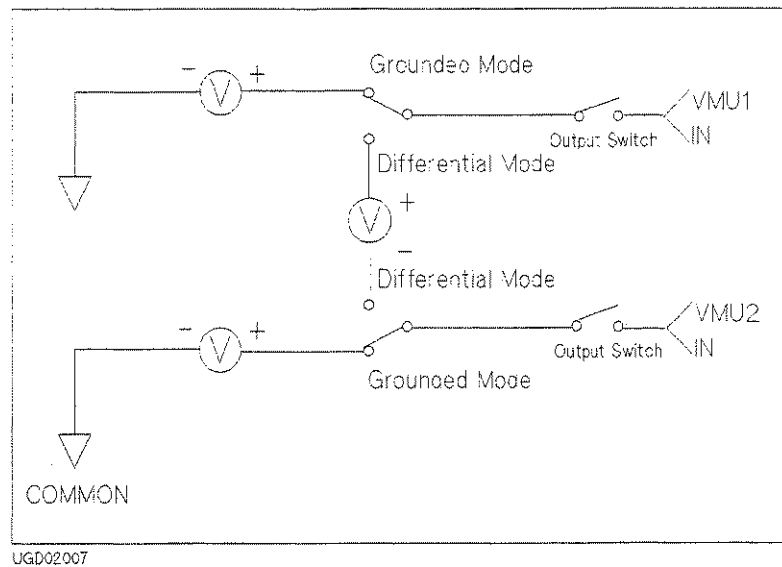

VMU can measure up to 20 V. Table 1-13 shows the voltage measurement range of VMU.

Measurement Units
Voltage Monitor Unit (VMU)

Table 1-13 VMU Voltage Ranges and Resolutions

Measurement Mode	Range	Measurement Resolutions ^a			
		Integration Time			High Speed Sampling Measurement ^b
		1PLC or Longer	640 μ s to 1.92 ms	80 μ s to 560 μ s	
Grounded Measurement	2 V	2 μ V	20 μ V	200 μ V	2 mV
	20 V	20 μ V	200 μ V	2 mV	20 mV
Differential Measurement	0.2 V	1 μ V	2 μ V	20 μ V	200 μ V
	2 V	2 μ V	20 μ V	200 μ V	2 mV

- a. Measurement resolution depends on the integration time setting. For Knob sweep measurement, see 20 V Range (for Grounded mode) and 2 V Range (for Differential mode) of Integration Time 80 μ s to 560 μ s.
b. This column is applied to the sampling measurement that *initial interval* is set to 480 μ s or shorter.

When you perform knob sweep measurement,

- only 20 V range is available for grounded measurement mode
- only 2 V range is available for differential measurement mode

NOTE

Bias Current of Buffer Amplifier may Damage DUT

The following figure shows a circuit diagram of a VMU.

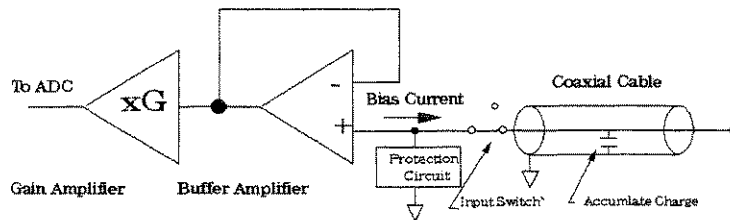

When a coaxial cable is connected to VMU and when the measurement terminal of VMU is open, the charge of the bias buffer amplifier current in the VMU increases the measurement terminal voltage.

After a long time charge, connecting DUT to the measurement terminal may damage the DUT by the discharging.

For the details of how to prevent this damage, refer to “If Measurement Damages the Device under Test” in Chapter 8.

NOTE

High Impedance DUT

Very high impedance DUT may cause measurement error due to the input leakage current from VMU.

To check the measurement error, perform voltage measurement as follows:

1. Connect SMU to the DUT.
 2. Force very low current (under 1 pA) to the DUT from SMU.
 3. Measure voltage by SMU.
 4. Compare the voltage measured by SMU and VMU.
-

Pulse Generator Unit (PGU)

Two pulse generator units (PGUs) are available, which are in the 41501A/B (SMU and pulse generator expander). Each PGU provides a pulsed output, and can also function as a dc source. For pulsed output of PGU, you can select 50 Ω or Low impedance. Figure 1-8 shows simplified PGU circuit diagram.

Figure 1-8

Simplified PGU Circuit Diagram

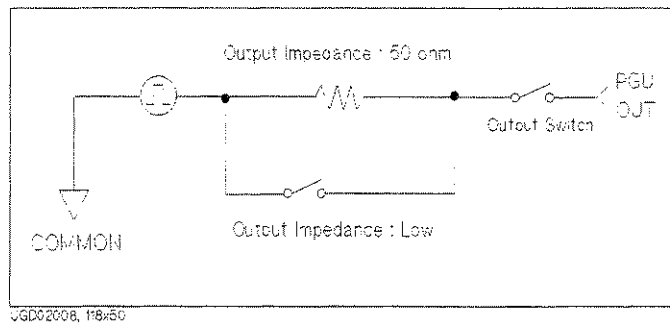

The PGU output value is defined to be the value that is output if the PGU output terminal is open. So, when a load is connected and PGU impedance is set to 50 Ω , the actual output value will be different. For example, if connected load is 50 Ω , specified PGU output impedance is 50 Ω , and specified output value is 2 V, the PGU outputs 1 V.

Table 1-14 shows the PGU setting ranges and resolutions.

Table 1-14

PGU Setting Ranges and Resolutions

Range	Peak Setting Value ^a	Base Setting Value	Resolution	Maximum Current ^b
20 V	$0 \leq V \leq 20 \text{ V}$	$0 \leq V \leq 20 \text{ V}$	4 mV	$\pm 100 \text{ mA}$
40 V	$0 \leq V \leq 40 \text{ V}$	$0 \leq V \leq 40 \text{ V}$	8 mV	$\pm 100 \text{ mA}$

a. Maximum peak-to-peak voltage is 40 V.

b. If pulse width $\leq 1 \text{ ms}$, pulse duty is $\leq 50 \%$, and average current output is $\leq \pm 100 \text{ mA}$, the peak current output can be up to $\pm 200 \text{ mA}$.

Measurement Units
Pulse Generator Unit (PGU)

If the impedance of the load connected to the PGU differs from the specified impedance in the IMPEDANCE field on the MEASURE: PGU SETUP screen or the STRESS: STRESS SETUP screen, the average output current may exceed 100 mA. If so, a warning message is displayed.

When you use two PGUs, the outputs are *always* synchronized with each other. The PGUs cannot be synchronized with the other measurement units.

The following describe each pulse parameter. For more details, see “MEASURE: PGU SETUP screen” in Chapter 6.

Pulse count

Allowable range: 1 to 65535. If you use two PGUs, both PGUs are set to the same pulse count. You *cannot* set different values for each PGU.

Pulse period, pulse width, delay time

Each parameter has six setting ranges as shown in Table 1-15.

Table 1-15

Ranges of Pulse Period, Pulse Width and Delay Time

Range	Pulse Period	Pulse Width	Delay Time ^a	Resolution
1	2.0 μ s to 100.0 μ s	1.0 μ s to 99.9 μ s	0 to 100.0 μ s	0.1 μ s
2	100 μ s to 1000 μ s	1 μ s to 999 μ s	0 to 1000 μ s	1 μ s
3	1.00 ms to 10.00 ms	0.01 ms to 9.99 ms	0 to 10.00 ms	10 μ s
4	10.0 ms to 100.0 ms	0.1 ms to 99.9 ms	0 to 100.0 ms	100 μ s
5	100 ms to 1000 ms	1 ms to 999 ms	0 to 1000 ms	1 ms
6	1.00 s to 10.00 s	0.01 s to 9.99 s	0 to 10.00 s	10 ms

a. The setting range of delay time is $0 \leq \text{delay time} \leq \text{specified pulse period}$.

The pulse period, pulse width, and delay time must be set in the same range. Also, if you use two PGUs, both PGUs are set to the *same* pulse period value. So, these three parameters must be set in the same range for both PGUs.

Measurement Units
Pulse Generator Unit (PGU)

Leading-edge and trailing-edge transition time

The leading-edge and trailing-edge transition times have five setting ranges as shown in Table 1-16.

Table 1-16

Ranges and Resolutions of Leading and Trailing Transition Time

Range	Leading and Trailing Transition Time	Resolution
1	100 ns to 1000 ns	1 ns
2	0.50 μ s to 10.00 μ s	10 ns
3	5.0 μ s to 100.0 μ s	100 ns
4	50 μ s to 1000 μ s	1 μ s
5	0.5 ms to 10.00 ms	10 μ s

- restrictions
 - *leading-edge transition time* \leq *pulse width* \times 0.8.
 - *trailing-edge transition time* \leq (*pulse period* - *pulse width*) \times 0.8.
 - Leading and trailing-edge transition times for a PGU must be in the same range.

Output impedance

You can select 50 Ω or Low impedance.

Trigger output

PGUs output trigger signal to synchronize with external pulse generators. If an 41501A/B has PGUs, the 41501A/B has a trigger output terminal. For details of trigger functions, refer to “Trigger Function” in Chapter 3.

Measurement Mode

This chapter explains measurement modes of Agilent 4155B/4156B. The 4155B/4156B has the following two measurement modes:

- “Sweep Measurement Mode”
- “Sampling Measurement Mode”

Sweep Measurement Mode

For sweep measurements, the sweep source channels perform staircase sweep output of voltage or current, while the monitor channels measure voltage or current for each sweep step.

Only SMUs and VSUs can be sweep sources (VAR1, VAR2, and VAR1').

The 4155B/4156B provides three types of sweep measurement:

- “Basic Sweep Measurement”
One sweep source (VAR1) is used.
- “Subordinate Sweep Measurement”
A primary (VAR1) and secondary sweep source (VAR2) are used.
- “Synchronous Sweep Measurement”
A primary (VAR1) and synchronous sweep source (VAR1') are used.

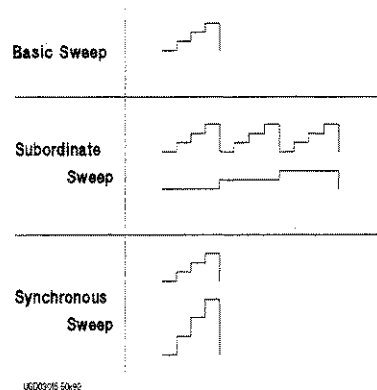

Also, you can set up a combined subordinate and synchronous sweep measurement.

In addition to the normal dc sweep, the sweep or constant source output can be pulsed to prevent thermal drift of the DUT.

Measurement Mode
Sweep Measurement Mode



Basic Sweep Measurement

Basic sweep measurement uses one sweep source (VAR1).

The following sweep types are available:

- LIN/LOG
 - Linear staircase
 - Logarithmic staircase
- SWEEP MODE
 - Single Source channel sweeps the output from user specified *start* value to *stop* value.
 - Double Source channel sweeps the output from user specified *start* value to *stop* value, then from *stop* value to *start* value.

You can select any combination of LIN/LOG and SWEEP MODE as shown in the following table:

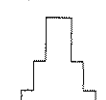
	Single Sweep	Double Sweep
Linear Sweep		
Log Sweep		

UGD03001

Measurement Mode

Sweep Measurement Mode

<i>start</i>	Start value of sweep. For logarithmic sweep, <i>start</i> must not be zero. Allowable range of <i>start</i> depends on output range of sweep source. For output range of each measurement channel, refer to Chapter 1.
<i>stop</i>	Stop value of single sweep or turning back value of double sweep. For logarithmic sweep, <i>stop</i> must have same polarity as <i>start</i> , and must not be zero. Allowable range of <i>stop</i> depends on output range of sweep source. For output range of each measurement channel, refer to Chapter 1.
<i>step</i>	<ul style="list-style-type: none">• For linear sweep, <i>step</i> is step increment of sweep. Number of sweep steps is calculated from <i>start</i>, <i>stop</i>, and <i>step</i>. Calculated number of steps must be in range: 2 to 1001.• For logarithmic sweep, <i>step</i> is invalid. Number of sweep steps is calculated from <i>start</i>, <i>stop</i>, and number of steps in one decade, which is specified by <i>log</i> parameter. Calculated number of steps must be in range: 2 to 1001.
<i>compliance</i>	Compliance value of sweep source. This parameter applies to SMU only. Allowable range of <i>compliance</i> depends on the compliance range of sweep source. For the compliance range of each measurement channel, refer to Chapter 1.
<i>power compliance</i>	(Optional) Power compliance value of sweep source. This parameter applies to SMU only. Allowable range depends on power compliance range of sweep source. For details, refer to Chapter 3.
<i>hold time</i>	Time required for DUT to settle after forcing start value. Allowable range is 0 to 655.35s. Resolution: 10 ms.
<i>delay time</i>	Time required for DUT to settle after stepping the output. Allowable range: 0 to 65.535 s. Resolution: 100 μ s

Refer to “CHANNELS: CHANNEL DEFINITION screen” and “MEASURE: MEASURE SETUP screen” in Chapter 6 for setting up these parameters.

Subordinate Sweep Measurement

For subordinate sweep measurement, you set up a secondary sweep source (VAR2) in addition to a primary sweep source (VAR1). After primary sweep is completed, the output of secondary sweep source is incremented or decremented by the specified step value, then the primary sweep source is swept again.

Figure 2-2

Subordinate Sweep Measurement

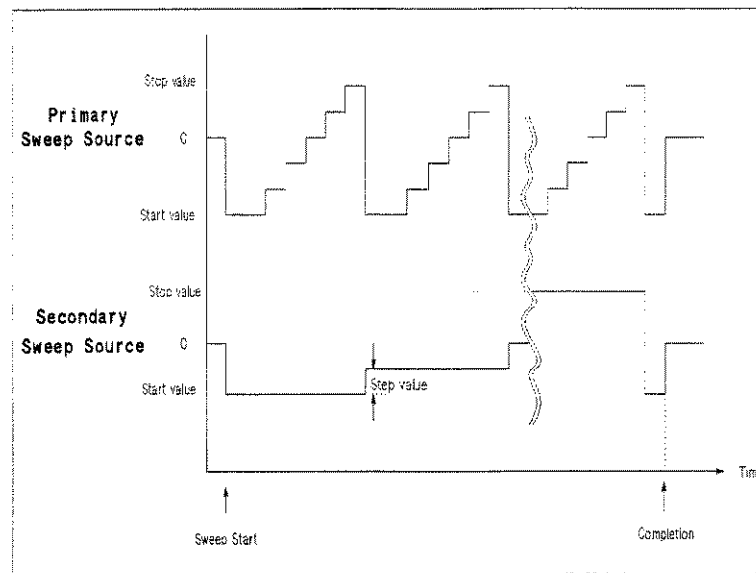

To set up the subordinate sweep measurement, select the following on CHANNELS: CHANNEL DEFINITION page:

- VAR1 function for desired primary sweep source (SMU or VSU).
- VAR2 function for desired secondary sweep source (SMU or VSU).

Subordinate sweep measurement has the following restriction:

- For the secondary sweep source, only *single* sweep mode and *linear* staircase mode are available.

Measurement Mode
Sweep Measurement Mode

Parameters

The parameters for primary sweep source (VAR1) are same as the parameters for sweep source of basic sweep measurement. For secondary sweep source (VAR2), specify the following parameters on MEASURE: SWEEP SETUP page.

Parameter	Description
<i>start</i>	Start value of secondary sweep. Allowable range of <i>start</i> depends on the output range of secondary sweep source. For the output range of each measurement channel, refer to Chapter 1.
<i>step</i>	Step increment of secondary sweep.
<i>number of steps</i>	Number of secondary sweep steps. Allowable range: 1 to 128.

NOTE

Stop value

Stop value of secondary sweep is calculated from *start*, *step*, and *number of steps*. Allowable range of *stop* depends on the output range of secondary sweep source. For the output range of each measurement channel, refer to Chapter 1.

compliance Compliance value of secondary sweep source. This parameter applies to SMU only. Allowable range of *compliance* depends on the compliance range of secondary sweep source. For the compliance range of each measurement channel, refer to Chapter 1.

power compliance (Optional) Power compliance value of secondary sweep source. This parameter applies to SMU only. Allowable range of *power compliance* depends on the power compliance range of sweep source. For details, refer to Chapter 3.

Synchronous Sweep Measurement

For synchronous sweep measurement, you set up a synchronous sweep source (VAR1') in addition to a primary sweep source (VAR1). The output of the synchronous sweep source is swept synchronously with the output of the primary sweep source at a constant offset value and ratio.

Figure 2-3

Synchronous Sweep Measurement

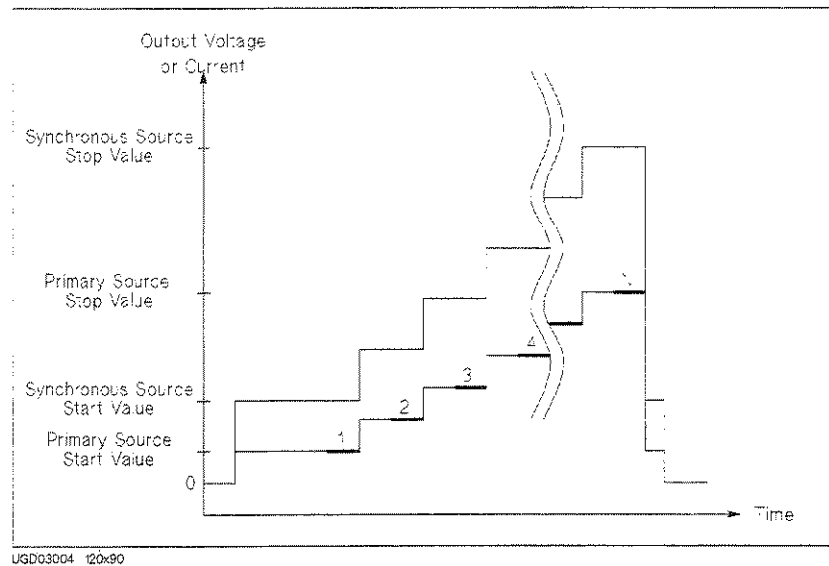

To set up synchronous sweep measurement, select the following on CHANNELS: CHANNEL DEFINITION page:

- VAR1 function for desired primary sweep source (SMU or VSU).
- VAR1' function for desired synchronous sweep source (SMU or VSU).

Synchronous sweep mode has the following restrictions:

- For the following, VAR1' is always set to the same mode as VAR1:
 - linear/log staircase
 - single/double sweep mode
- VAR1 and VAR1' must be same V/I output mode. For example, if VAR1 is set to V mode, then VAR1' must be set to V or VPULSE mode.

Measurement Mode
Sweep Measurement Mode

Parameters

The parameters for primary sweep source (VAR1) are same as the parameters for sweep source of basic sweep measurement. For synchronous sweep source (VAR1'), specify the following parameters on MEASURE: SWEEP SETUP page.

Parameter	Description
<i>offset</i>	Offset between outputs of primary and synchronous sweep sources.
<i>ratio</i>	Ratio between outputs of primary and synchronous sweep sources.
<i>compliance</i>	Compliance value of synchronous sweep source. This parameter applies to SMU only. Allowable range of <i>compliance</i> depends on the compliance range of synchronous sweep source. For the compliance range of each measurement channel, refer to Chapter 1.
<i>power compliance</i>	(Optional) Power compliance value of synchronous sweep source. This parameter applies to SMU only. Allowable range of <i>power compliance</i> depends on the power compliance range of synchronous sweep source. For details, refer to Chapter 3.

The relationship between the output of primary and synchronous sweep sources is determined by the following equation:

$$\textit{synchronous output} = \textit{primary output} \times \textit{ratio} + \textit{offset}$$

The synchronous output determined by above equation must not exceed the output range of synchronous sweep source.

Pulse Sweep Measurement

For a sweep measurement, a sweep or constant source SMU can be a pulse source. But *only one* SMU can be a pulse source. Figure 2-4 shows the relationship between pulse source and other sources.

Figure 2-4

Pulse Source and Other Sources

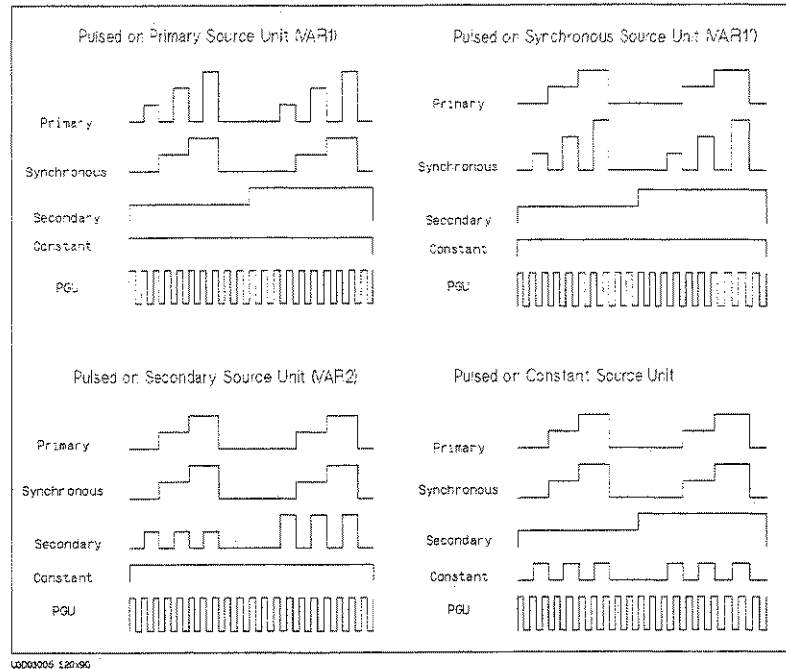

For the pulse sweep measurement, the delay time of the primary sweep source is ignored, and each step of the primary sweep source is synchronized with output of the SMU pulse source. Measurements are made during the pulse output.

The pulse output of PGU is not synchronized with any other source.

Measurement Mode
Sweep Measurement Mode

Figure 2-5

SMU Pulse

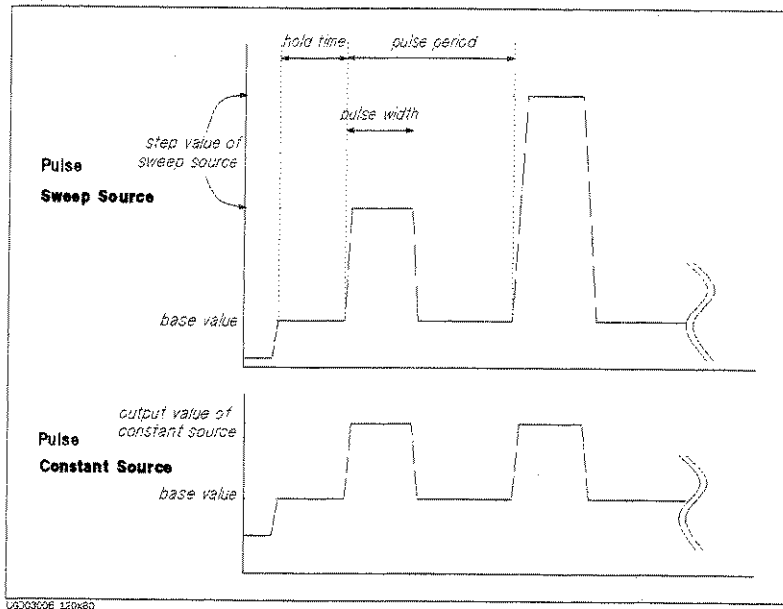

Parameters

Specify SMU pulse parameters (MEASURE: SWEEP SETUP):

Parameter	Description
<i>pulse period</i>	SMU forces the next pulse after specified <i>pulse period</i> . Allowable range: 5 ms to 1 s. Resolution: 100 μ s.
<i>pulse width</i>	Time from when SMU output starts to change from <i>base value</i> to time when SMU starts to return from peak value. Measurements are made while the peak value is output. Allowable range: 0.5 ms to 100 ms. Resolution: 100 μ s.
<i>base value</i>	The base output value of the SMU pulse.

Be aware that if any of following are true, pulsed SMU channel may not output the pulse period and pulse width you specified:

- Measurement range differs from compliance range (lowest range that includes compliance).
- Ranging mode is set to auto range or limited auto range.
- Multi-channel measurement is set.

Measurement Mode
Sweep Measurement Mode

NOTE

Pulse width

If the measurement settings do not meet the following conditions, *pulse width* setting of SMU may be insufficient to make measurement. If so, the pulse width is automatically changed to be appropriate.

Number of Meas. Channels: 1
Integration Time: Short
Ranging Mode: Fixed

Measurement Mode
 Sampling Measurement Mode

Sampling Measurement Mode

For a sampling measurement, you can monitor current or voltage changes at a DUT while forcing constant current, constant voltage, or pulsed constant bias.

The 4155B/4156B provides the following three types of sampling measurement according to the sampling interval:

- “Linear Sampling Measurement”
- “Thinned-out Sampling Measurement”
- “Logarithmic Sampling Measurement”

Available Units

Available units and functions for sampling measurement are shown below:

Unit	Output Function					Output Mode			Pulse	Meas. Mode	
	VAR1	VAR1'	VAR2	CONST	STANDBY	V	I	COM		V	I
SMU	n.a.	n.a.	n.a.	•	•	•	•	•	n.a.	•	•
VSU	n.a.	n.a.	n.a.	•	•	•	–	–	–	–	–
VMU	–	–	–	–	–	–	–	–	–	•	–
GNDU	–	–	–	•	–	–	–	•	–	–	–
PGU	–	–	–	•	•	•	–	–	•	–	–

n.a. means “This is *not* available for sampling measurement”.

• means “This is available for sampling measurement”.

– means “This is *not* available for this unit”.

For sampling measurements, only the PGU output can be pulsed.

The pulse output timing from PGU is not synchronized with the timing of sampling measurement.

Sampling Interval and Measurement Time

When the sampling interval enough longer than the actual measurement time, measurement unit repeats measurement every specified sampling interval. However, if the sampling interval is less than the measurement time, measurement unit cannot repeat measurements every specified interval. For example, if the measurement time is one and a half the specified sampling interval, the interval of measurement is two times the sampling interval. See Figure 2-6 which explains the operation of the sampling measurement.

Measurement time depends on the measurement condition: integration time, measurement range, and so on. So if you want to execute sampling measurement with the specified sampling interval, you need to know the actual measurement time upon your measurement setup, and set the sampling interval value enough longer than the actual measurement time. You can see typical measurement time by repeating the sampling measurements with several sampling interval settings. See “Sampling Measurement Data” on page 2-18.

Measurement time is given by the following fomula:

$$T_{\text{meas}} = T_{\text{integ}} + T_{\text{oh}}$$

where,

T_{meas} : Measurement time.

T_{integ} : Integration time.

T_{oh} : Overhead time caused by the following elements:

- range changing time during measurement (when measurement ranging mode is set to auto or limited auto)
- range changing time at measurement start (when using measurement range less than the compliance value)
- time required for the compensation: getting compensation data and compensating measurement data (when the automatic compensation is set and executed)

Measurement Mode
 Sampling Measurement Mode

Figure 2-6

Sampling Measurement Operation Summary

Case 1. Sampling Interval > Meas. Time

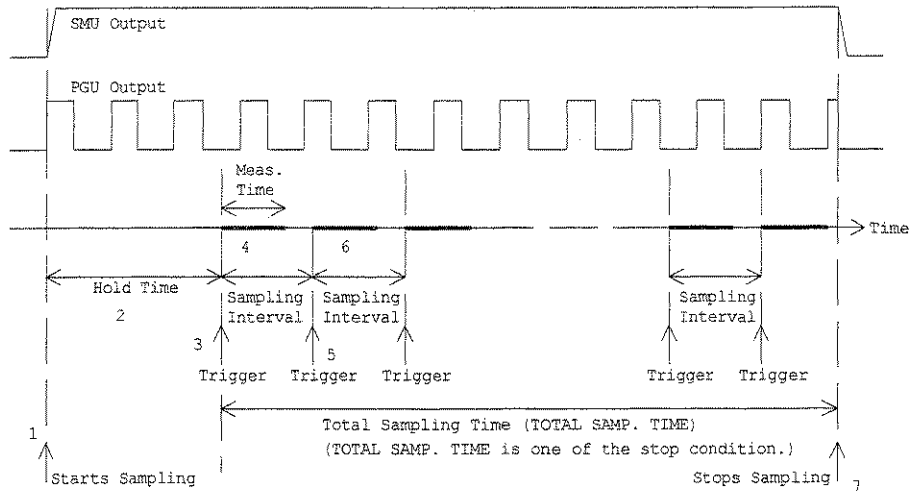

Case 2. Sampling Interval < Meas. Time

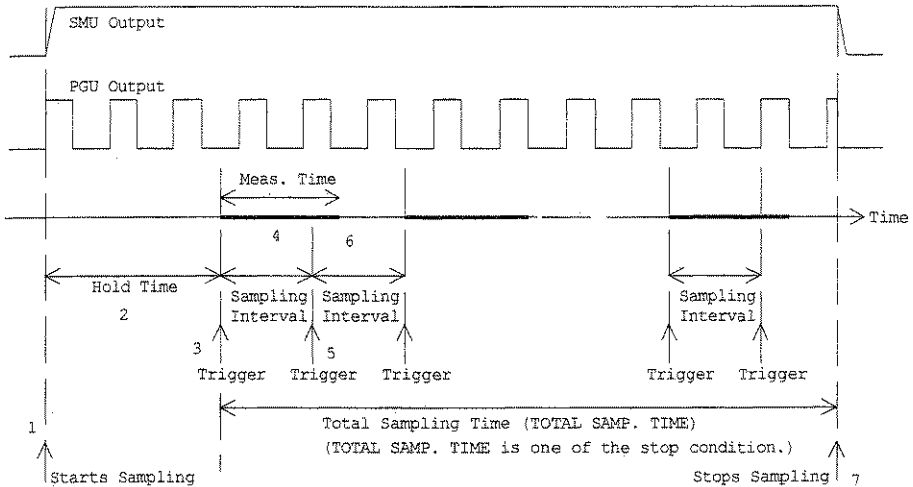

Measurement Mode
Sampling Measurement Mode

Sampling measurement is executed as explained below:

1. Forces constant current, constant voltage, or pulsed constant bias.
2. Waits hold time.
3. Triggers one point measurement.
4. Measurement unit executes measurement. Measurement result data is stored in memory.
5. Triggers one point measurement. Interval of trigger is same as *Sampling Interval*.
6. (Case 1) Measurement unit executes measurement if it is ready to measure. Measurement result data is stored in memory.
(Case 2) Measurement unit waits next trigger if it is busy or in measurement.
7. Repeats steps 5 and 6 until that a sampling completion condition is satisfied.

In Figure 2-6, sampling measurement stops when the completion condition *total sampling time* is satisfied.

Number of measurement data stored in memory depends on the sampling completion condition. Maximum number is specified by the NO. OF SAMPLES field of the MEASURE: SAMPLING SETUP screen. However the measurement will be immediately stopped if a sampling completion condition is satisfied before reaching the maximum number. For the sampling completion condition, see "Sampling Completion" on page 2-20.

Measurement Mode
Sampling Measurement Mode

Sampling Measurement Data

Measurement parameters of sampling measurement are set to the NAME column of the DISPLAY: DISPLAY SETUP screen. Available parameters and example parameters for the NAME field are listed in the table below:

Parameter Name	Meanings of Parameter
@TIME	Measurement start time. This is the time the measurement unit starts one point measurement. This is different from timing of the measurement trigger sent every sampling interval.
@INDEX	Data index. Integer. This is the index numbered to measurement data stored in memory.
V1	for example, SMU1 voltage output value or measured value.
I1	for example, SMU1 current output value or measured value.

Measurement start time can be expressed by the following formula. This formula is available for the measurement points before starting the discarding operation for the linear sampling or thinned-out sampling. For logarithmic sampling, this is available for the measurement points in the first decade.

$$@TIME = Thold + Tinterval \times [(@INDEX - 1) + N]$$

where,

@TIME : Measurement start time.

Thold : Hold time.

Tinterval : Sampling interval.

@INDEX : Data index.

N : Number of triggers between two nearest measurement points. This value is 0 if the sampling interval is enough longer than the measurement time.

Measurement Mode
Sampling Measurement Mode

For example, if $T_{hold}=10$ ms, $T_{interval}=5$ ms, and @TIME values are as shown below, estimated measurement time is 15 ms to 20 ms, and there are 3 triggers between @INDEX=1 and @INDEX=2.

- @TIME (for @INDEX=1) = 10 ms = $10 + 5 \times [(1 - 1) + 0]$ ms
- @TIME (for @INDEX=2) = 30 ms = $10 + 5 \times [(2 - 1) + 3]$ ms

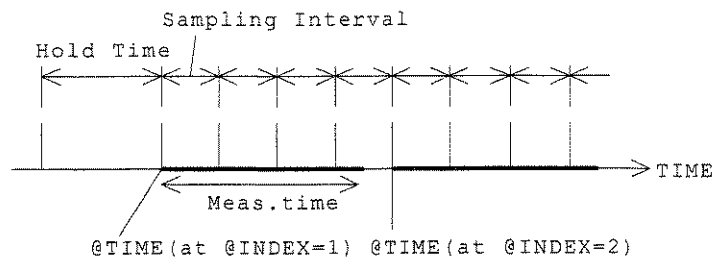

To Use Multiple Measurement Units

If you define multiple measurement parameters in the NAME column of the DISPLAY: DISPLAY SETUP screen, sampling measurement is executed by using multiple measurement units. Differences between this measurement and the measurement using only one unit are shown below:

- Measurement Sequence
 - Measurement units start measurement in the order below:
 - Parameters for GRAPH: X → Y1 → Y2
 - Parameters for LIST: Order of No. assigned for the parameters
- Value of @TIME
 - @TIME stores the time the first measurement unit starts measurement.
 - @TIME does not store the time another unit starts measurement.
- Measurement Time
 - Measurement time is sum of the measurement time by all units. To execute sampling measurement with the specified sampling interval, the sampling interval must be enough longer than the measurement time.

Measurement Mode
Sampling Measurement Mode

Sampling Completion

The sampling measurement completes when one of the following conditions is satisfied:

- Stop condition
The stop condition is satisfied. See below.
- Total sampling time
The specified total sampling time has elapsed.
Available for linear and thinned-out sampling. Setting TOTAL SAMP. TIME to auto or no limit disables this sampling completion condition.
- Number of sampling points
The specified number of samples has elapsed.
Available for logarithmic sampling. For linear sampling, setting TOTAL SAMP. TIME to auto enables this sampling completion condition.
- Stop front-panel key
The Stop front-panel key is pressed.
- GPIB Command
The 4155B/4156B receives GPIB command to stop sampling.
- Emergency Condition
An emergency condition occurs on the 4155B/4156B.
- Interlock Open
Interlock terminal opens due to high voltage.

Stop Condition

The stop condition is defined by using the STOP CONDITION table of MEASURE: SAMPLING SETUP screen. This function stops the measurement as shown below.

1. Compares the value of the parameter set to NAME field and the value defined in THRESHOLD field.
2. Counts how many times the selected EVENT occurs.
3. When the count reaches the value defined in EVENT NO. field, sampling is stopped immediately.

Measurement Mode
Sampling Measurement Mode

To use this function, the INITIAL INTERVAL value must be set to 2 ms or more. The INITIAL INTERVAL is the minimum resolution of the sampling interval. For details about the INITIAL INTERVAL, see “Linear Sampling Measurement” on page 2-24, “Thinned-out Sampling Measurement” on page 2-27, or “Logarithmic Sampling Measurement” on page 2-30.

To set up the stop condition, specify the following parameters on the MEASURE: SAMPLING SETUP screen.

Parameter	Description
ENABLE/ DISABLE	Enables or disables the stop condition.
ENABLE DELAY	Delay time, in second. This is the time from starting sampling measurement to enabling this function. Allowable range: 0 to INITIAL INTERVAL × 32767 s. Resolution: INITIAL INTERVAL.
NAME	Name of measurement data or user function to monitor for stop condition. Val of EVENT.
THRESHOLD	Threshold value at which to stop sampling measurement. Th of EVENT.
EVENT	Event for stop condition. Val > Th True if NAME parameter value is greater than THRESHOLD value. Val < Th True if NAME parameter value is less than THRESHOLD value. Val > Th True if absolute NAME parameter value is greater than absolute THRESHOLD value. Val < Th True if absolute NAME parameter value is less than absolute THRESHOLD value.
EVENT NO.	Target value of the count the event occurs (<i>true</i>). When the count of <i>true</i> is this value, sampling is immediately stopped. Allowable range: 1 to 200.

Measurement Mode
Sampling Measurement Mode

Source Output Sequence and Time Origin

Source unit output sequence and the time origin depends on the setup value of the OUTPUT SEQUENCE MODE OF SAMPLING field in the MEASURE: OUTPUT SEQUENCE screen. The following two modes are available for the field.

- SIMULTANEOUS mode

All source unit starts output at same timing. This timing is defined as the Time Origin. See figure below.

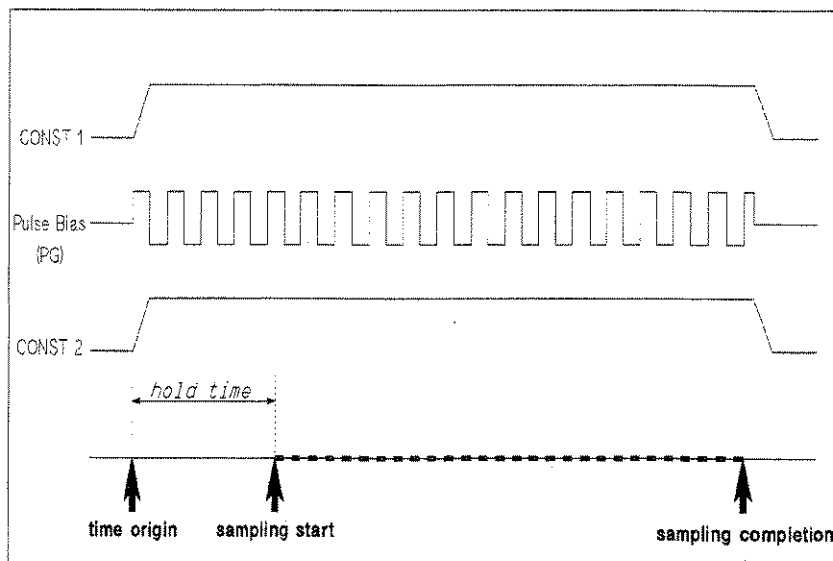

UG003014 120x80

Measurement Mode
Sampling Measurement Mode

- SEQUENTIAL mode

Source units starts output in the order defined in the OUTPUT SEQUENCE table of the MEASURE: OUTPUT SEQUENCE screen. Time Origin is when the last source reaches the specified output value. See figure below.

If there is pulse bias sources (PGUs), they start to force pulse base value in the order shown above, and start to force pulse bias at the Time Origin.

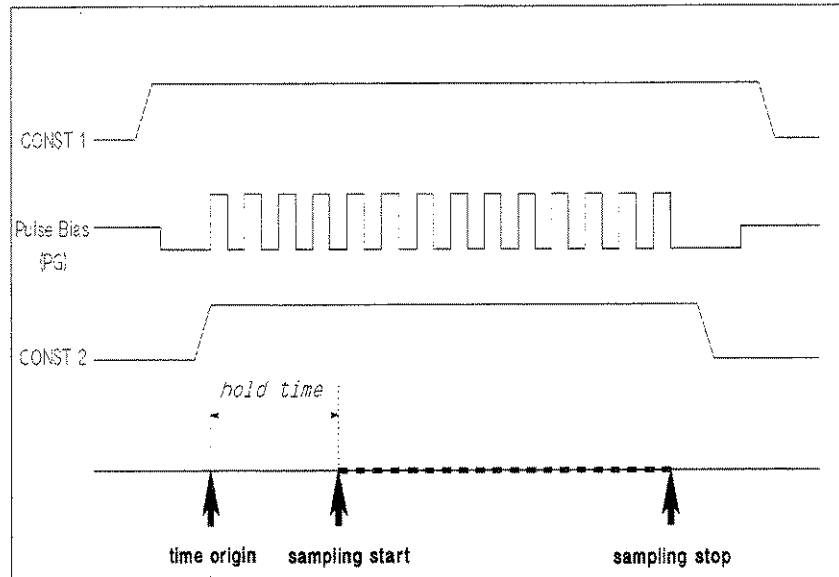

UG003007 120x80

Measurement Mode
Sampling Measurement Mode

Linear Sampling Measurement

Linear sampling mode keeps a constant sampling interval that is the interval of measurement trigger. And if the measurement units are ready to measure, the units start measurement, and the result data is stored in memory. This is repeated until one of the sampling completion conditions is satisfied.

However, if both the following two conditions occur, linear sampling mode changes the sampling interval to two times the previous sampling interval, and continues sampling measurement.

- number of sampling points reaches specified NO. OF SAMPLES
- sampling completion condition is not satisfied

Example Operation

This example assumes the following sampling setup:

- INITIAL INTERVAL value is longer than the measurement time
 - NO. OF SAMPLES value is set to 10
 - TOTAL SAMP. TIME is long (for example, $50 \times$ INITIAL INTERVAL). Do not set to AUTO which enables the *number of sampling points* sampling completion condition.
1. Executes one point measurement, and stores data in memory. Repeats this 10 times every sampling interval (INITIAL INTERVAL setting value) because of the sampling interval enough longer than the measurement time.

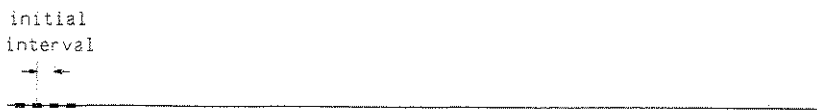

2. If the sampling completion condition is not satisfied after 10 points measurement, linear sampling mode changes the sampling interval to two times the INITIAL INTERVAL, and continues sampling measurement.

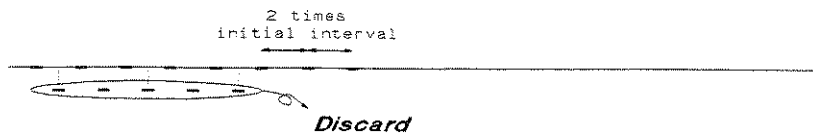

To store new measurement data, linear sampling mode discards a data every couple of nearest data as shown above. Data is updated every measurement.

Measurement Mode
Sampling Measurement Mode

3. If the sampling completion condition is not satisfied after additional 5 points measurement, linear sampling mode changes the sampling interval to two times the previous interval, and continues sampling measurement. Measurement data is updated as described in step 2.

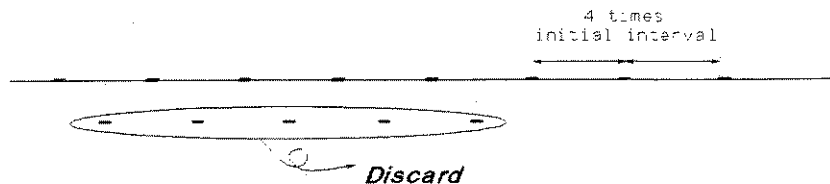

4. This discarding and doubling of the sampling interval is repeated until the sampling completion condition is satisfied. By the end of the measurement, 10 measurement result data is stored in memory.

Parameters

To set up the linear sampling measurement, specify the following parameters on MEASURE: SAMPLING SETUP page. See Table 2-1.

Parameter	Description
MODE	Sampling mode. LINEAR.
INITIAL INTERVAL	The sampling interval for first NO.OF SAMPLES samples. Allowable range: 60 μ s to 65.535 s.
NO.OF SAMPLES	Number of data to be stored by end of measurement. Maximum: 10001. If there are multiple measurement units, this value must be 10001/(number of units) or less.
TOTAL SAMP.TIME	Total sampling time. Does not include HOLD TIME. This is the time from the 1st trigger to the sampling completion. One of the sampling completion conditions, so sampling stops after this time elapses. <ul style="list-style-type: none"> • Allowable range when INITIAL INTERVAL \leq 480 μs: AUTO • Allowable range when INITIAL INTERVAL $>$ 480 μs: INITIAL INTERVAL \times (NO.OF SAMPLES - 1) sec to 1×10^{11} sec, AUTO, or NO LIMIT.
AUTO	Enables the <i>number of sampling points</i> sampling completion condition.
NO LIMIT	Disables the <i>total sampling time</i> sampling completion condition

Measurement Mode
Sampling Measurement Mode

HOLD TIME Hold time. This is the time from starting source output to first trigger. If this value is 0, first @TIME value is 0.

- Allowable range when INITIAL INTERVAL ≥ 2 ms: 0 to 655.35 s with 100 μ s resolution.
- Allowable range when INITIAL INTERVAL < 2 ms: - 30 ms to 655.35 s with 100 μ s resolution.

Table 2-1 Effective Parameter Values

INITIAL INTERVAL	60 μ s to 480 μ s	560 μ s to 1.92 ms	2 ms to 65.535 s
NO. OF SAMPLES	Max. 10001/(number of measurement units)		
TOTAL SAMP. TIME	AUTO	AUTO/NO LIMIT/ INITIAL INTERVAL \times (NO. OF SAMPLES - 1) s to 1×10^{11} s	
HOLD TIME	- 30 ms to 655.35 s, 100 μ s resolution		0 to 655.35 s, 100 μ s resolution
Stop Condition	DISABLE		DISABLE/ENABLE
Measurement Units ^a	1 ^b		Max. 8 ^c
Measurement Range ^d	FIX		FIX/AUTO/LIMITED
Integration Time ^e	Short		Short/Medium/Long

^a Number of units (SMUs or VMUs) used for measurements.

^b If voltage source SMU is connected to R-BOX, only this SMU can be used for the measurement.

^c Maximum 8 units if the 41501 is used (6 SMUs and 2 VMUs). If multiple measurement units are used, total measurement time will be more than the sum of the measurement time by all units.

^d If compliance value is more than the measurement range, range change when starting measurement makes long measurement time. Also if ranging mode is set to AUTO or LIMITED, range changing makes long measurement time.

^e Integration time is an element of the measurement time. If automatic measurement data compensation is executed, the measurement time will be more than two times the integration time.

Thinned-out Sampling Measurement

Thinned-out sampling mode operates like the linear sampling mode. Difference is that the sampling interval is not changed in the thinned-out sampling measurement. So even if both the following two conditions occur, thinned-out sampling mode does not change the sampling interval, and continues sampling measurement.

- number of sampling points reaches specified NO. OF SAMPLES
- sampling completion condition is not satisfied

Example Operation

This example assumes the following sampling setup:

- INITIAL INTERVAL value is longer than the measurement time
 - NO. OF SAMPLES value is set to 10
1. Executes one point measurement, and stores data in memory. Repeats this 10 times every sampling interval (INITIAL INTERVAL setting value) because of the sampling interval enough longer than the measurement time.

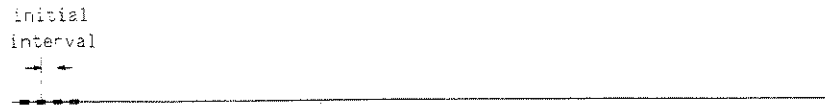

2. If the sampling completion condition is not satisfied after 10 points measurement, thinned-out sampling mode keeps the sampling interval, and continues sampling measurement.

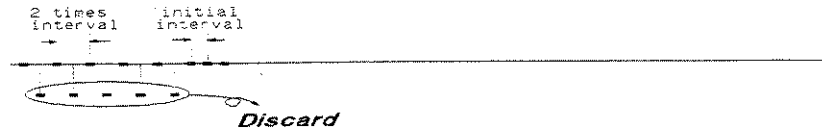

To store new measurement data, thinned-out sampling mode discards a data every couple of nearest data as shown above. Data is updated every measurement.

Measurement Mode
Sampling Measurement Mode

3. If the sampling completion condition is not satisfied after additional 5 points measurement, thinned-out sampling mode keeps the sampling interval, and continues sampling measurement. Data is updated as described in step 2.

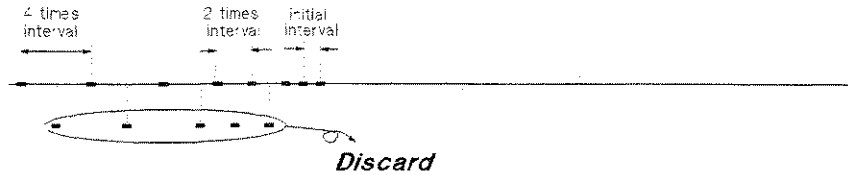

4. This discarding is repeated until the sampling completion condition is satisfied. By the end of the measurement, 10 measurement result data is stored in memory.

Parameters

To set up the thinned-out sampling measurement, specify the following parameters on MEASURE: SAMPLING SETUP page. See Table 2-2.

Parameter	Description
MODE	Sampling mode. THINNED OUT.
INITIAL INTERVAL	The sampling interval during thinned-out sampling. Allowable range: 720 μ s to 65.535 s.
NO.OF SAMPLES	Number of data to be stored by end of measurement. Maximum: 10001. If there are multiple measurement units, this value must be 10001/(number of units) or less.
TOTAL SAMP.TIME	Total sampling time. Does not include HOLD TIME. This is the time from the 1st trigger to the sampling completion. One of the sampling completion conditions, so sampling stops after this time elapses. Allowable range: NO LIMIT, or $INITIAL\ INTERVAL \times (NO.OF\ SAMPLES - 1)$ sec to 1×10^{11} sec
NO LIMIT	Disables the <i>total sampling time</i> sampling completion condition
HOLD TIME	Hold time. This is the time from starting source output to first trigger. If this value is 0, first @TIME value is 0. <ul style="list-style-type: none"> • Allowable range when INITIAL INTERVAL ≥ 2 ms: 0 to 655.35 s with 100 μs resolution. • Allowable range when INITIAL INTERVAL < 2 ms: - 30 ms to 655.35 s with 100 μs resolution.

Measurement Mode
Sampling Measurement Mode

Table 2-2 Effective Parameter Values

INITIAL INTERVAL	720 μ s to 1.92 ms	2 ms to 65.535 s
NO. OF SAMPLES	Max. 10001/(number of measurement units)	
TOTAL SAMP. TIME	NO LIMIT/ INITIAL INTERVAL \times (NO. OF SAMPLES - 1) s to 1×10^{11} s	
HOLD TIME	- 30 ms to 655.35 s, 100 μ s resolution	0 to 655.35 s, 100 μ s resolution
Stop Condition	DISABLE	DISABLE/ENABLE
Measurement Units ^a	1 ^b	Max. 8 ^c
Measurement Range ^d	FIX	FIX/AUTO/LIMITED
Integration Time ^e	Short	Short/Medium/Long

^a Number of units (SMUs or VMUs) used for measurements.

^b If voltage source SMU is connected to R-BOX, only this SMU can be used for the measurement.

^c Maximum 8 units if the 41501 is used (6 SMUs and 2 VMUs). If multiple measurement units are used, total measurement time will be more than the sum of the measurement time by all units.

^d If compliance value is more than the measurement range, range change when starting measurement makes long measurement time. Also if ranging mode is set to AUTO or LIMITED, range changing makes long measurement time.

^e Integration time is an element of the measurement time. If automatic measurement data compensation is executed, the measurement time will be more than two times the integration time.

Measurement Mode
Sampling Measurement Mode

Logarithmic Sampling Measurement

Logarithmic sampling mode plots the measurement data on the X-axis (@TIME) set to the logarithmic scale by doing the following operation. See Figure 2-7.

1. Forces constant current, constant voltage, or pulsed constant bias.
 2. Waits hold time.
 3. Triggers one point measurement.
 4. Measurement unit executes measurement. Measurement result data is stored in memory.
 5. Triggers one point measurement. Interval of trigger is constant (setting value of INITIAL INTERVAL).
 6. Measurement unit executes measurement if it is ready to measure. Measurement result data is stored in memory.
- Measurement unit waits next trigger if it is busy or in measurement.
7. Repeats steps 5 and 6 until that a sampling completion condition is satisfied.
- Logarithmic sampling mode retains only the measurement data that can plot the data on the logarithmic X-axis in almost the same interval.

Figure 2-7

Example Operation of Logarithmic Sampling

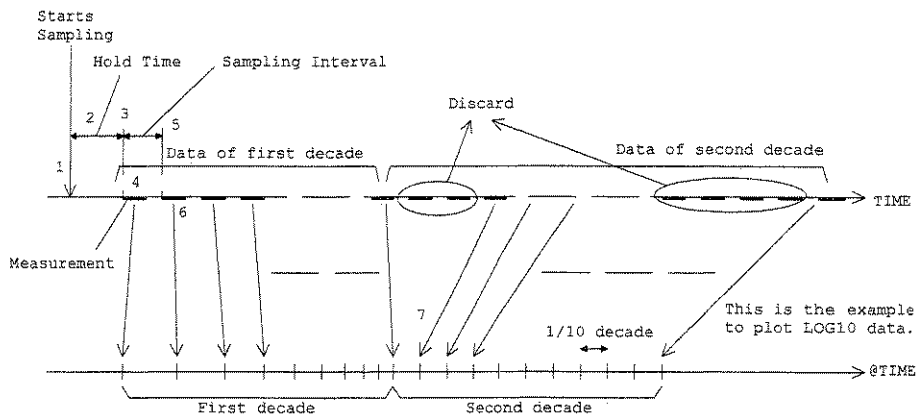

@TIME Value

@TIME value of measurement data is determined by MODE, INITIAL INTERVAL, NO. OF SAMPLES, and HOLD TIME parameters. Where MODE decides number of measurement points in 1 decades. For example, LOG10 mode obtains 10 data per 1 decade.

An example to get measurement data in logarithmic sampling measurement is explained below. This example assumes the following settings. See also Figure 2-7.

- MODE = LOG10 (10 data / 1 decade)
- INITIAL INTERVAL = 10 ms
- NO. OF SAMPLES = 20
- HOLD TIME = 10 ms
- STOP CONDITION = DISABLE

If sampling interval is enough longer than measurement time:

INITIAL INTERVAL value decides the range of a decade.

10 ms to 100 ms (1st decade) Sampling is executed at the following @TIME value: 10 ms, 20 ms, 30 ms, 40 ms, 50 ms, 60 ms, 70 ms, 80 ms, 90 ms, 100 ms. LOG10 mode allows to have 10 data in 1 decade. Therefore all measurement data is stored in memory.

100 ms to 1 s There are 90 sampling points in this range. Number of data can remain is only 10. They can plot the data on the X-axis in almost the same interval.

@TIME values are as follows:

140 ms, 170 ms, 210 ms, 270 ms, 330 ms, 410 ms, 520 ms, 650 ms, 810 ms, 1.02 s.

If sampling interval is less than measurement time:

Measurement time decides the range of a decade. If the measurement time is 18 ms, interval of measurement is 20 ms, and the following data are stored in memory:

20 ms to 200 ms (1st decade) Sampling is executed at the following @TIME value: 20 ms, 40 ms, 60 ms, 80 ms, 100 ms, 120 ms, 140 ms, 160 ms, 180 ms, 200 ms. LOG10 mode allows to have 10 data in 1 decade. Therefore all data is stored in memory.

200 ms to 2 s There are 90 sampling points in this range. Number of data can remain is only 10. They can plot the data on the X-axis in almost the same interval.

Measurement Mode
 Sampling Measurement Mode

Rule to determine @TIME:

@TIME value is determined by the following rule. Data measured at @TIME= T_{log} are stored in memory.

$$T_{log} \geq T_{target}$$

$$|T_{log} - T_{target}| < |T_{target} - T_{prev}|$$

where,

T_{log} Data stored in @TIME. Actual measurement point.

T_{target} Target value of @TIME. The values can plot data on the logarithmic X-axis in the same interval completely.

T_{prev} $T_{log} - \text{sampling interval}$. Actual measurement point.

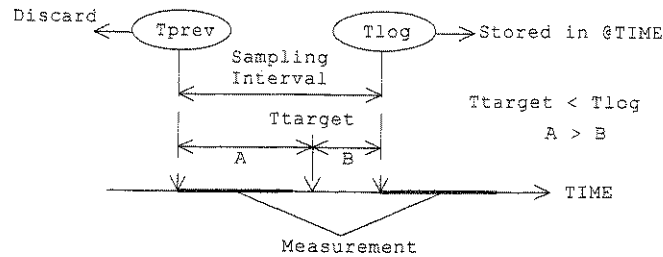

$$A = |T_{target} - T_{prev}|$$

$$B = |T_{log} - T_{target}|$$

Parameters

To set up the logarithmic sampling measurement, specify the following parameters on MEASURE: SAMPLING SETUP page. See Table 2-3.

Parameter	Description
MODE	Sampling mode. LOG10, LOG25, or LOG50.

MODE	Number of data in 1 decade
LOG10	10
LOG25	25
LOG50	50

INITIAL INTERVAL	<p>The sampling interval during logarithmic sampling. Allowable range: 560 μs to 65.535 s.</p> <p>If this value is 560 μs to 10 ms, number of measurement data may be less than the specified number of data for top 2 decades. Then sampling continues to get all samples.</p>
------------------	---

NO. OF SAMPLES	<p>Number of data to be stored by end of measurement. One of the sampling completion conditions, so sampling stops after this point elapses. Maximum 11 decades.</p>
----------------	--

MODE	Maximum value
LOG10	111
LOG25	276
LOG50	551

HOLD TIME	<p>Hold time. This is the time from starting source output to first trigger. If this value is 0, first @TIME value is 0.</p>
-----------	--

- Allowable range when INITIAL INTERVAL \geq 2 ms: 0 to 655.35 s with 100 μ s resolution.
- Allowable range when INITIAL INTERVAL $<$ 2 ms: - 30 ms to 655.35 s with 100 μ s resolution.

Example:

HOLD TIME=1.003 s, and measurement interval is 3 ms, decade and its range are as shown below:

decade	Range (in sec)
1st decade	1.003 to 1.030 (3 m +1 to 30 m +1)
2nd decade	1.030 to 1.300 (30 m +1 to 300 m +1)
3rd decade	1.300 to 4.00 (300 m +1 to 3+1)
4th decade	4 to 31 (3+1 to 30+1)
5th decade	31 to 301 (30+1 to 300+1)

Measurement Mode
 Sampling Measurement Mode

Table 2-3

Effective Parameter Values

INITIAL INTERVAL	560 μ s to 1.92 ms	2 ms to 65.535 s
NO. OF SAMPLES	Maximum 111 (LOG10), 276 (LOG25), 551 (LOG50)	
HOLD TIME	- 30 ms to 655.35 s, 100 μ s resolution	0 to 655.35 s, 100 μ s resolution
Stop Condition	DISABLE	DISABLE/ENABLE
Measurement Units ^a	1 ^b	Max. 8 ^c
Measurement Range ^d	FIX	FIX/AUTO/LIMITED
Integration Time ^e	Short	Short/Medium/Long

^a Number of units (SMUs or VMUs) used for measurements.

^b If voltage source SMU is connected to R-BOX, only this SMU can be used for the measurement.

^c Maximum 8 units if the 41501 is used (6 SMUs and 2 VMUs). If multiple measurement units are used, total measurement time will be more than the sum of the measurement time by all units.

^d If compliance value is more than the measurement range, range change when starting measurement makes long measurement time. Also if ranging mode is set to AUTO or LIMITED, range changing makes long measurement time.

^e Integration time is an element of the measurement time. If automatic measurement data compensation is executed, the measurement time will be more than two times the integration time.

Measurement Functions

This chapter explains functions that can be used in measurements. Agilent 4155B/4156B has the following useful measurement functions.

- “Stress Force Function”
- “Knob Sweep Function”
- “Operation States”
- “Output Sequence”
- “Trigger Function”
- “R-BOX Control”
- “Measurement Ranging Mode”
- “Compliance”
- “Integration Time”
- “SMU Filter”
- “Zero Offset Cancel”

Stress Force Function

When you press the Stress front-panel key in the MEASUREMENT key group, stress is forced to the DUTs for the specified period. The 4155B/4156B can force both dc stress and ac stress (pulsed stress) as shown in the following figure.

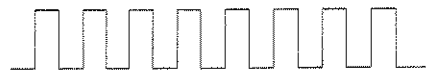

(a) AC Stress Signal

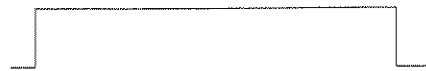

(b) DC Stress Signal

setting the stress channels

You can set up units for the stress force state on the STRESS: CHANNEL DEFINITION screen independently from the measurement and standby states that you set on the CHANNELS: CHANNEL DEFINITION screen.

For example, you can use the same SMU as a measurement channel in the measurement state, and as a stress force source in the stress force state.

switching channels connected to DUT

The 4155B/4156B can control Agilent 16440A SMU/Pulse Generator Selector to automatically switch units that are connected to a DUT pin. You set up this automatic control on the STRESS: CHANNEL DEFINITION screen.

For example, the DUT pin is connected to a PGU for stress force when Stress front-panel key in the MEASUREMENT key group is pressed, then connected to an SMU for measurement when Single front-panel key is pressed.

For details about how to control the 16440A selector, refer to “SMU/PG Selector Control” on page 3-11, “To Control Selector for Switching SMU and PGU” in Chapter 4, and Chapter 2 of *User's Guide General Information*.

Measurement Functions
Stress Force Function

displaying the stress force time

The STRESS: STRESS FORCE screen is displayed while stress is being forced. On this screen, the time that stress has been forced is displayed and updated every second. For more details about the STRESS: STRESS FORCE screen, refer to “STRESS: STRESS FORCE screen” in Chapter 6.

Stress Output Channels

You can select up to four stress source channels among SMUs, VSUs, and PGUs.

To set a unit to be a stress source channel, set SYNC in the FCTN field on the STRESS: CHANNEL DEFINITION screen. On this screen, at least one channel must be set to SYNC. For details about the STRESS: CHANNEL DEFINITION screen, refer to “STRESS: CHANNEL DEFINITION screen” in Chapter 6.

The 4155B/4156B can force dc voltage stress, dc current stress, and ac voltage stress (by PGUs in Agilent 41501A/B), but cannot force ac current stress.

- available units and modes

Table 3-1 shows available units and allowable modes for stress sources.

Table 3-1

Available Units and Modes for Stress Force

Units	DC Voltage Stress	DC Current Stress	AC Voltage Stress
SMU	yes	yes	
VSU	yes		
PGU	yes		yes

Also, SMUs can be set to COMMON mode.

If you use two PGUs as *pulsed source* (VPULSE), you *cannot* set one PGU to SYNC (stress source channel) and the other PGU to NSYNC (non-stress source channel). That is, both PGUs must be SYNC or both must be NSYNC.

If a channel is set to STBY ON on the CHANNELS: CHANNEL DEFINITION screen, the channel cannot be set to SYNC.

NOTE

To Force Stress with more than Four Channels

The following trigger functions allow you to force stress from more than 4 channels by using external pulse generators, voltage sources, or current sources.

- gate trigger while stress is forced

The 4155B/4156B can output a gate trigger while stress channels are forcing stress. For details about this gate trigger, refer to “Trigger Function” on page 3-44.

- gate trigger of PGUs

The output trigger terminal of PGUs (41501A/B) can output a gate trigger to external pulse generators. So, use this function if you need more than two *ac* stress channels.

For example, you can use Agilent 8110A pulse generator to force *ac* stress by using this trigger.

PGU outputs a gate trigger that is synchronized with pulse output. For details of the trigger signal, refer to “Triggering an External Instrument” on page 3-47.

Measurement Functions
Stress Force Function

Stress Mode

You set stress mode to the pulse count mode or duration mode. The pulse count mode is used only when a PGU is used to force ac stress (that is, PGU is set to MODE=VPULSE and FCTN=SYNC on the STRESS:CHANNEL DEFINITION screen).

Pulse count mode

You specify the pulse count (1 to 65535). The total stress time is determined by the pulse count and pulse period.

Duration mode

You specify the total stress time directly in seconds. Allowable range is 500 μ s to 1 year ($3.1536 \cdot 10^7$ s).

setting resolution:

- When the specified time is 10 s or less:
setting resolution is 100 μ s.
- When the specified time is more than 10 s:
setting resolution is 10 ms.

Stress Force Sequence

Output sequence (idle state to the stress force state)

When the state changes from the idle state to the stress force state, the channels output the following values:

- ac stress (SYNC) channel: specified base value
- dc stress (SYNC) channel: 0 V or 0 A
- non-stress (NSYNC) channel: specified source value or pulse output

The output sequence of the channels depends on the order specified on the MEASURE: OUTPUT SEQUENCE screen. For details, refer to “Sequential Mode” on page 3-39.

Stress force sequence (in the stress force state)

- stress output
Stress force channels output stress at the same time when the stress start trigger is received. Stress start trigger is sent *hold time* after the last channel changes from idle state to stress force state.
- stress stop
Stress force channels stop stress at the same time. When you set up both ac and dc stress on the STRESS: CHANNEL DEFINITION screen, ac stress channels stop several microseconds before the dc stress channels.
If you set delay time for pulse stress, finish of stress force time is after the period of the last pulse. (See Figure 3-1 on page 3-8.)

NOTE

Pulse Waveform when Stress Stops

When you set the duration mode or press the Stop front-panel key, be aware that stress force may stop during the pulse peak output as shown in the following figure:

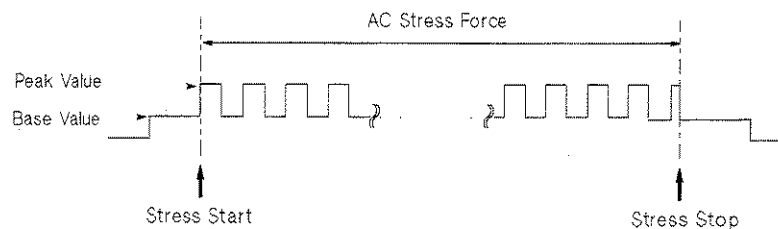

Measurement Functions
Stress Force Function

Sequence for returning to 0 V (stress force state to the idle state)

When the state changes from the stress state to the idle state, the outputs of the channels are returned to 0 V in opposite order that forcing occurred.

Delay time of PGUs

When PGUs are set to VPULSE (ac source), you can set a delay time as follows:

- If PGU is set to SYNC, the PGU waits the delay time (after the *stress start* trigger is received), then starts to force ac stress.
- If PGU is set to NSYNC, the PGU waits the delay time (after *stress force* state starts), then starts pulse output.

For details about delay time, refer to “MEASURE: PGU SETUP screen” in Chapter 6.

Example

Figure 3-1 shows an example of output sequence when forcing stress.

Figure 3-1

Example of the Stress Force Sequence

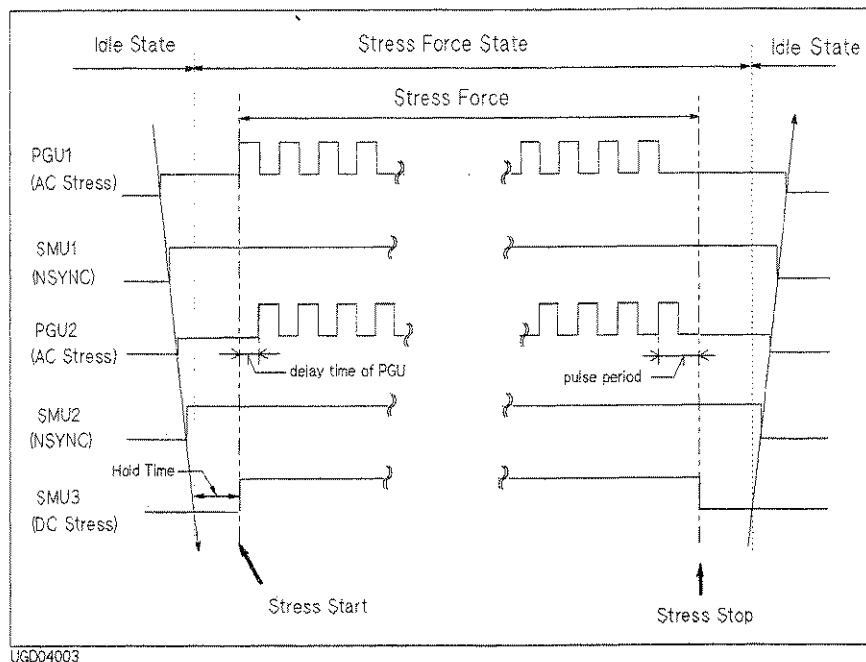

Measurement Functions Stress Force Function

Figure 3-1 assumes the output sequence is set on the MEASURE: OUTPUT SEQUENCE screen as follows.

1. PGU1
 2. SMU1
 3. PGU2
 4. SMU2
 5. SMU3
- output sequence (idle state to the stress state)
Specified output values are forced in the following order:
 1. PGU1
 2. SMU1
 3. PGU2
 4. SMU2
 5. SMU3
 - stress force sequence (in the stress force state)
The stress force channels (PGU1, PGU2, and SMU3) start stress and stop stress at the same time.
 - sequence for returning to 0 V (stress force state to the idle state)
The order of returning to 0 V is:
 1. SMU3
 2. SMU2
 3. PGU2
 4. SMU1
 5. PGU1

Measurement Functions
Stress Force Function

Stress Stop Function at Abnormal Status

On the STRESS: STRESS SETUP screen, you can select whether the stress stops or continues when an abnormal status occurs.

You can select one of the following in the STRESS Status field on the STRESS: STRESS SETUP screen:

- Stress continues even if an abnormal status occurs.
- Stress stops if any abnormal status occurs.
- Stress stops only if SMU reaches its compliance setting.

Abnormal statuses are as follows:

- SMU reaches its compliance setting.
- Current of a VSU exceeds ± 100 mA.
- SMU or a VSU oscillates.
- A/D converter overflow occurs.
- Average current of PGU exceeds ± 100 mA.

When an 4155B/4156B is stopped by the stress stop function, a message is displayed in the message display area.

STOP AT ANY ABNORM and STOP AT COMPLIANCE secondary softkeys are displayed only when specified duration is more than 10 s. If you set pulse count mode, these secondary softkeys are displayed only when $pulse\ period \times pulse\ count$ is more than 10 s.

The stress stop function is not effective until the stress has been forced for 10 seconds. For example, if STOP AT ANY ABNORM or STOP AT COMPLIANCE is selected and abnormal status occurs after forcing stress for 5 seconds, the stop function does *not* stop stress until stress is forced for 10 seconds.

SMU/PG Selector Control

The 4155B/4156B can control the 16440A SMU/Pulse Generator Selector to automatically switch units that are connected to a DUT pin. You set up this automatic control on the STRESS: CHANNEL DEFINITION screen.

For example, you can specify to connect the PGU to the DUT during stress, and connect the SMU to the DUT during measurement. So, when you press the Stress key in the MEASUREMENT key group, the PGU is automatically connected to the DUT. And when you press a measurement key, the SMU is automatically connected to the DUT.

You can use up to two 16440A selectors. For details about installation of the 16440A selectors, refer to Chapter 2 of *User's Guide General Information*.

When you use 16440A selector, SMUs *cannot* be connected to test devices by Kelvin connection.

Figure 3-2

Simplified Circuit Diagram of the 16440A Selector

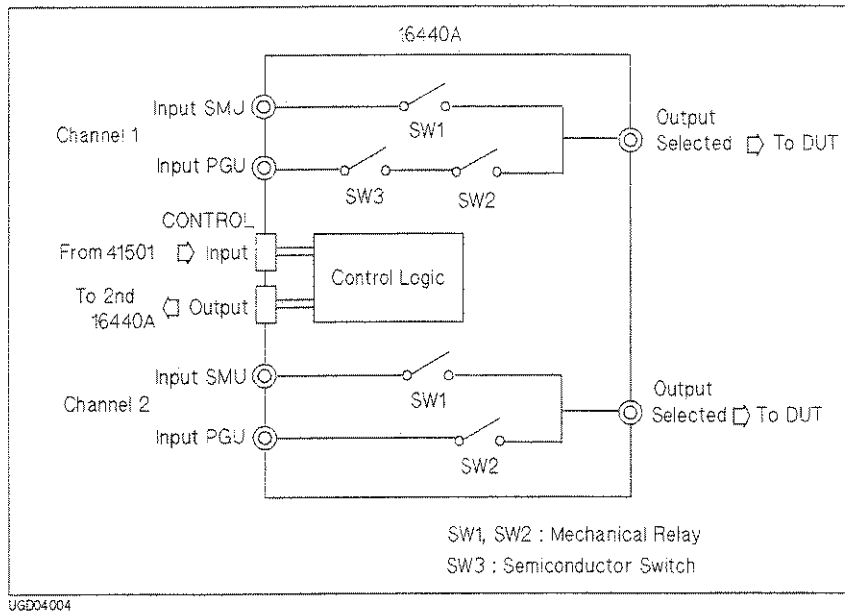

Measurement Functions
Stress Force Function

Setup and restrictions

If the 41501A/B does not have PGUs, you cannot use the 16440A selector.

Circuit diagram

Figure 3-2 shows the simplified circuit diagram of an 16440A selector.

Switching Conditions

Channel 1 provides the following four switching conditions. Channel 2 also provides these switching conditions, except for PGU OPEN.

Switching Condition	SW1	SW2	SW3
SMU	ON	OFF	OFF
PGU	OFF	ON	ON
OPEN	OFF	OFF	OFF
PGU OPEN	OFF	ON	OFF

where,

- SMU means: SMU is connected. PGU is not connected.
- PGU means: PGU is connected. SMU is not connected.
- OPEN means: Both PGU and SMU are disconnected.
- PGU OPEN means: Both PGU and SMU are disconnected. But PGU is disconnected by semiconductor relay. Mechanical relay stays connected.

NOTE

Semiconductor Switch

In Figure 3-2, SW3 is a semiconductor switch. Leak current and stray capacitance of SW3 are greater than for the mechanical relays (SW1 and SW2). However, the switching speed of SW3 is faster and life is longer than SW1 and SW2. So, if you need to switch PGU many times, switch SW3 instead of SW2.

Knob Sweep Function

The knob sweep function allows you to easily perform real-time sweep measurements by rotating the rotary knob on the front panel after setting a few parameters.

The knob sweep function is useful in the following cases:

- when you want to determine a parameter value for normal sweep
- when you want to quickly make a rough measurement of a DUT characteristic

While the KNOB SWEEP screen is displayed, the sweep measurements are repeated continuously with the specified sweep values. You can change the setting parameters by using the secondary softkeys on the KNOB SWEEP screen, even while the measurements are being performed.

When knob sweep measurements are started, the VAR1 start value and VAR1 sweep range are 0 V or 0 A. You change the sweep range and watch the measurement results by rotating the knob.

For details about using the knob sweep function, refer to Chapter 4.

Available units and functions

Table 3-2 shows available units and functions for knob sweep measurement.

Table 3-2 Available Units and Functions for Knob Sweep Measurement

Unit	Output Function					Output Mode			Pulse	Meas. Mode		
	VAR1	VAR1'	VAR2	CONST	STAND BY	V	I	COMM ON		V	DVOLT	I
SMU	•	n.a.	•	•	•	•	•	•	n.a.	•	–	•
VSU	•	n.a.	•	•	•	•	–	–	–	–	–	–
VMU	–	–	–	–	–	–	–	–	–	•	•	–
GNDU	–	–	–	•	–	–	–	•	–	–	–	–
PGU	–	–	–	•	•	•	–	–	•	–	–	–

• means "This is available for knob sweep measurement".

n.a. means "This is not available for knob sweep measurement".

– means "This is not available for this unit".

Measurement Functions
Knob Sweep Function

Comparison of normal sweep and knob sweep measurements

Table 3-3 compares the normal sweep measurement performed by measurement front-panel keys and knob sweep measurement by the front-panel knob.

Table 3-3

Comparison of Sweep Measurement and Knob Sweep Measurement

Item	Sweep Measurement	Knob Sweep Measurement
Spacing of VAR1	linear or log	linear
Sweep Mode of VAR1	single or double	single or double
Number of Steps for VAR1	1 to 1001	1 to 1001
Hold Time	0 to 655.35 s	0 to 655.35 s
Power Compliance	available	not available
Measurement Ranging Mode	auto, limited auto, or fixed	compliance range ^a
Standby Function	available	available
Measurement Channel	1 to 8 ch	1 ch only
Output Sequence	can set	can set ^b
Trigger Function	available	not available
Integration Time	short, medium, or long	80 μ s

^a Measurement range is automatically set according to specified compliance value.

^b Settings on the MEASURE: OUTPUT SEQUENCE screen also apply to knob sweep measurement.

Features of Knob Sweep Function

The following are parameters that are for knob sweep measurement only or that have a different meaning or range from normal sweep measurement. Other parameters have the same meaning and range as normal sweep measurement. For details of these other parameters, refer to “KNOB SWEEP screen” on page 3-20 or Chapter 2.

LIN/LOG mode

Only linear mode is available. Even if you set LOG in the LIN/LOG field on the MEASURE: SWEEP SETUP screen, the knob sweep is a linear sweep measurement.

VAR1 Range

To set the VAR1 range, refer to VAR1 RANGE softkey description in this section. If you do not set the VAR1 range, the default is the stop value specified for the VAR1 channel on the MEASURE: SWEEP SETUP screen.

Polarity

The following sweep polarities are available for the knob sweep function of the VAR1 source:

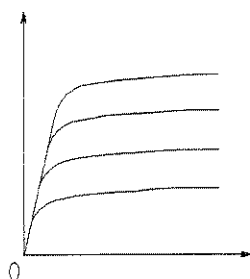

(a) positive

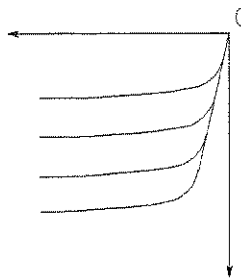

(b) negative

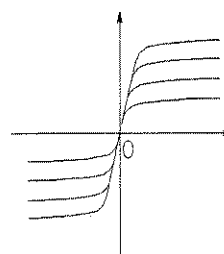

(c) bipolar

Measurement Functions
Knob Sweep Function

- positive

Select *positive* to set VAR1 source for sweep in the positive X direction.

- To increase the source value toward the positive X direction:

Rotate the rotary knob clockwise.

- To decrease the source value toward 0:

Rotate the rotary knob counterclockwise. When measurement curves reach 0, the curves remain at 0 even if you continue to rotate the rotary knob counterclockwise.

- negative

Select *negative* to set VAR1 source for sweep in the negative X direction.

- To increase (greater absolute value) the source value toward the negative X direction:

Rotate the rotary knob counterclockwise.

- To decrease the source value toward 0:

Rotate the rotary knob clockwise. When measurement curves reach 0, the curves remain at 0 even if you continue to rotate the rotary knob clockwise.

- bipolar

Select *bipolar* to set the VAR1 source for sweep in both the positive and negative X directions.

- To increase (greater absolute values) the source values in both directions:

Rotate the rotary knob clockwise. This increases the measurement curves to the same absolute value in both directions.

- To decrease the source value toward 0:

Rotate the rotary knob counterclockwise. This decreases the measurement curves toward 0 from both directions. When measurement curves reach 0, the curves remain at 0 even if you continue to rotate the rotary knob counterclockwise.

To set sweep polarity, see POLARITY softkey description in this section.

Measurement Functions Knob Sweep Function

Step Time

For knob sweep measurements, you cannot set the delay time. Instead, you set the step time, which you can only set on the KNOB SWEEP screen. Step time is the time width of a sweep step as shown in the following figure.

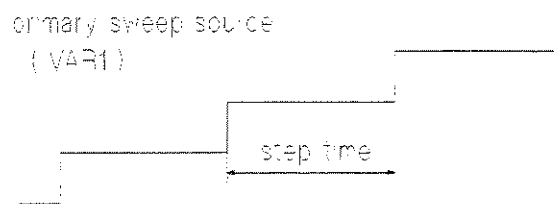

Setup range is 0.5 ms to 100 ms, with 100 μ s resolution.

For normal sweep measurement, the step time of each step depends on the measurement time. For knob sweep measurement, step time is *always* this specified value.

Measurement Channel

You select the measurement channel by selecting the Y-AXIS ASSIGN softkey on the KNOB SWEEP screen, then selecting the desired secondary softkey. You can select one measurement channel only, so the Y2 axis is not available on the KNOB SWEEP screen.

- restrictions

If you use series resistance for VAR1 channel and VAR1 channel is V force mode, only VAR1 measurement channel can be assigned to Y axis.

- default measurement channel

- When an SMU is set to VAR1

Measurement channel is the VAR1 channel.

- When a VSU is set to VAR1

Measurement channel is the first found channel that can measure. Searching order is:

SMU1 \rightarrow \rightarrow SMU6 \rightarrow VMU1 \rightarrow VMU2.

Measurement Functions
Knob Sweep Function

NOTE

Measurement Resolution

When performing knob sweep measurement, measurement resolution of each measurement unit is worse than the measurement resolution of normal sweep measurements. For details of measurement resolution, refer to Chapter 1.

Step Value

For the VAR1 channel, you do not set the step value. You can consider the step value to be the amount you rotate the knob. Then, the sweep is performed and displayed for the specified *number of steps*. Step value of VAR1 is 0 at the time when you initiate the knob sweep function. Step value range is 0 to $VAR1\ range/number\ of\ steps$. For knob sweep measurements, the value in the STEP field on the MEASURE: SWEEP SETUP screen has no meaning.

Number of Steps

For the VAR1 channel, you set the number of steps on the KNOB SWEEP screen. So, for the knob sweep function, the number of steps for VAR1 has no relation to the NO OF STEP setting on the MEASURE: SWEEP SETUP screen.

Start Value

The start value is always 0, and does not depend on the polarity. You cannot set the start value. So, the START setting on the MEASURE: SWEEP SETUP screen has no meaning for the knob sweep function.

Stop Value

Stop value is always $step\ value \times number\ of\ steps$. You cannot set the stop value. The measurement is continuously repeated from 0 to the stop value until the Stop front-panel key is pressed or the KNOB SWEEP screen is changed to another screen.

Measurement Ranging Mode

Measurement ranging mode depends on the unit as follows:

- SMUs

Compliance range is used for SMUs. That is, the measurement range is set to the lowest range that includes the compliance value that is set on the MEASURE: SWEEP SETUP screen. For details about compliance range, refer to “Compliance Range” on page 3-59.

- VMUs
VMUs measure in 20 V range for grounded measurement mode and the 2 V range for differential measurement mode.

NOTE

Analysis of the Knob Sweep Measurement Results

- On the KNOB SWEEP screen
You cannot use analysis functions and user functions on the KNOB SWEEP screen.
- On the GRAPH/LIST screen group
After performing knob sweep measurements, you can copy and display the knob sweep measurement results to the GRAPH/LIST: GRAPH screen or GRAPH/LIST: LIST screen by doing the following:

1. Press the SETUP COPY primary softkey on the KNOB SWEEP screen.
2. Press the Graph/List front-panel key.

The knob sweep results are displayed on the GRAPH/LIST screen. You can use the analysis functions on the measurement results of knob sweep.

Also, you can use user functions in GRAPH/LIST screen group. Before performing knob sweep measurement, you must set up user functions as follows:

1. Define user functions on CHANNELS: USER FUNCTION DEFINITION screen.
2. Enter user functions in DATA VARIABLES field of DISPLAY: DISPLAY SETUP screen.
3. On GRAPH/LIST: GRAPHICS screen, select DISPLAY SETUP primary softkey, then set DATA VAR softkey to ON.

When you press Graph/List front-panel key after knob sweep measurement, the user functions will be displayed.

Graph/List key:

If you press the Graph/List front-panel key, the START and STOP values of VAR1 column on the MEASURE: SWEEP SETUP screen are changed to the start and stop values that are determined by the KNOB SWEEP screen.

Measurement Functions
Knob Sweep Function

KNOB SWEEP screen

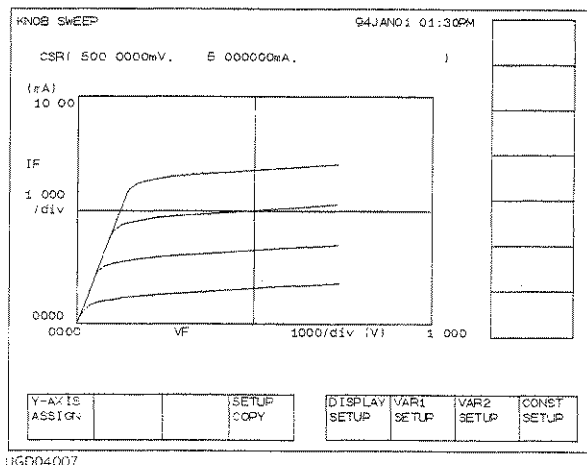

To display the KNOB SWEEP screen, press the green key, then press the Single front-panel key. On this screen, you can set knob sweep parameters by using the secondary softkeys, and the knob sweep measurement results are shown on this screen.

If you change from the KNOB SWEEP screen to another screen, then back to the KNOB SWEEP screen, all knob sweep parameters are set to the default settings.

You can select softkeys on the KNOB SWEEP screen even while the 4155B/4156B is performing knob sweep measurements.

Cursor

On the KNOB SWEEP screen, the long cursor is always displayed, and you cannot turn it off. In the CURSOR field, coordinate values of the cursor are displayed in X, Y order.

X axis setting

The variable to be displayed on X axis is automatically set to VAR1 source value, and you cannot change it. Maximum value of X axis scale is the value you set on the VAR1 RANGE secondary softkey of the VAR1 SETUP group.

Y axis setting

The measurement variable of the measurement channel is displayed on the Y axis. You can select the measurement channel by using the secondary softkeys of the Y-AXIS ASSIGN group. Maximum value of Y axis scale is the compliance value of the selected measurement channel.

Measurement Functions Knob Sweep Function

The following explain softkeys on the KNOB SWEEP screen.

Y-AXIS ASSIGN

Press Y-AXIS ASSIGN primary softkey to display the measurement data variable names of measurement channels. Variable names are displayed on secondary softkeys, which you select to set the variable to the Y axis. When you select the secondary softkey, the maximum absolute value(s) of the Y axis are changed to compliance value of the selected measurement channel. You cannot assign a user function to Y axis on the KNOB SWEEP screen.

If you select this softkey during a measurement, an error occurs. So, press Stop front-panel key before selecting this softkey.

If you use series resistance for VAR1 channel and VAR1 channel is V force mode, Y-AXIS ASSIGN primary softkey is not displayed. VAR1 channel is automatically set to the Y axis.

SETUP COPY

Press SETUP COPY primary softkey to copy setups on the KNOB SWEEP screen as follows:

- Axis variables, axis values, and GRID settings of KNOB SWEEP screen are copied to the DISPLAY: DISPLAY SETUP screen.
- For VAR1
Values are copied to START, STOP, STEP, and NO OF STEP fields of MEASURE: SWEEP SETUP screen. Values are determined by VAR1 POLARITY setting and curve that is displayed on KNOB SWEEP screen.
SWEEP MODE, HOLD TIME, and COMPLIANCE that you set for VAR1 on KNOB SWEEP screen are copied to MEASURE: SWEEP SETUP screen.
- For VAR2, all the settings that you set for VAR2 on the KNOB SWEEP screen are copied to the MEASURE: SWEEP SETUP screen.
- For CONST, all the settings that you set for CONST on the KNOB SWEEP screen are copied to the MEASURE: SWEEP SETUP screen.

Measurement Functions
Knob Sweep Function

DISPLAY SETUP

Press DISPLAY SETUP primary softkey to display secondary softkeys for setting the display format of graphics.

Setups on the DISPLAY: DISPLAY SETUP screen are *not* used for the knob sweep measurement. But you can copy the settings of the DISPLAY SETUP key group to the DISPLAY: DISPLAY SETUP screen by pressing SETUP COPY primary softkey.

X-AXIS REGION

+ Polarity of X-axis region is displayed on this secondary softkey. This determines which part of the graph is displayed: negative X region, positive X region, or both.

- setting

Pressing this softkey toggles polarity as follows:

+ → - → +/- → +

- default

If polarity of VAR1 stop and start value on MEASURE: SWEEP SETUP screen are same, default value is same as polarity of stop and start value.

If polarity of VAR1 stop and start value on MEASURE: SWEEP SETUP screen are different, default value is +/-.

Y-AXIS REGION

+ Polarity of Y-axis region is displayed on this secondary softkey. This determines which part of the graph is displayed: negative Y region, positive Y region, or both.

- setting

Pressing this softkey toggles the polarity in the following order:

+ → - → +/- → +

- default

polarity of VAR1 compliance value on the MEASURE: SWEEP SETUP screen

Measurement Functions
Knob Sweep Function

**X-AXIS
DISPLAY**

NORMAL Direction of values on X-axis is displayed on this softkey.

- setting

Selecting this softkey toggles NORMAL or REVERSE.

When NORMAL is selected:

- *Minimum* axis value is at *left* end of X-axis.
- *Maximum* axis value is at *right* end of X-axis.

When REVERSE is selected:

- *Minimum* axis value is at *right* end of X-axis.
- *Maximum* axis value is at *left* end of X-axis.

- default : NORMAL

**Y-AXIS
DISPLAY**

NORMAL Direction of values on Y-axis is displayed on this softkey.

- setting

Selecting this softkey toggles NORMAL or REVERSE.

When NORMAL is selected:

- *Minimum* axis value is at *bottom* of Y-axis.
- *Maximum* axis value is at *top* of Y-axis.

When REVERSE is selected:

- *Minimum* axis value is at *top* of Y-axis.
- *Maximum* axis value is at *bottom* of Y-axis.

- default : NORMAL

GRID ON Present status of grid is displayed on GRID softkey.

- setting

Pressing GRID secondary softkey toggles the grid on or off in the plotting area.

- default : ON

Measurement Functions
Knob Sweep Function

VAR1 SETUP

Press VAR1 SETUP primary softkey to display secondary softkeys for setting the VAR1 parameters.

SWEEP MODE

SINGLE Sweep mode is displayed on this secondary softkey.

- setting

Pressing this softkey toggles the sweep mode in the following order:

SINGLE → DOUBLE → SINGLE

- default

setting of the SWEEP MODE field on the MEASURE: SWEEP SETUP screen

POLAR- ITY POS

Polarity of sweep is displayed on this secondary softkey.

- setting

Pressing this softkey toggles the polarity of VAR1 channel in the following order:

POS → NEG → BIPOLAR → POS

Pressing this softkey resets the sweep step to 0, so the sweep measurement curve goes back to 0 on the graphics display.

- default

If polarity of VAR1 stop and start value on MEASURE: SWEEP SETUP screen are same, default value is same as polarity of stop and start value.

If polarity of VAR1 stop and start value on MEASURE: SWEEP SETUP screen are different, default value is BIPOLAR.

VAR1 RANGE

2V Sweep range of VAR1 channel is displayed on this secondary softkey. This softkey setting defines the maximum sweep range and resolution of VAR1 channel.

Measurement Functions Knob Sweep Function

- setting

Select this softkey to display the VAR1 sweep range value in the data entry area, then you can change this range to allowed 1-2-5 values by using the rotary knob.

When you rotate the rotary knob, the sweep ranges are displayed in order as shown in the following example (allowed values depend on the unit):

0.1 V → 0.2 V → 0.5 V → ... → 100 V → 200 V → 0.1 V

- setting range

The allowed sweep range (1-2-5) values depend on the output range of the measurement unit. See Chapter 1.

- default

lowest 1-2-5 range that includes *VAR1 start and stop value* that is set on the MEASURE: SWEEP SETUP screen

For example, if stop value is set to 30 V on the MEASURE: SWEEP SETUP screen, default VAR1 range is 50 V.

NUM OF STEPS

101

Number of steps for VAR1 channel is displayed on this secondary softkey. For knob sweep, NO OF STEP setting on MEASURE: SWEEP SETUP screen has no meaning.

- setting

Press this softkey to display the number of steps in the data entry area, then you can change the number of steps by using the rotary knob, or numeric keys and arrow keys in the Edit key group.

- setting range : 2 to 1001

- default : 101

Measurement Functions
Knob Sweep Function

**COMPLI-
ANCE**

- 100.mA** Compliance value for VAR1 channel is displayed on this secondary softkey.
- setting
Press this softkey to display the compliance value in the data entry area. Then, you can change the compliance value by using the rotary knob, or numeric keys and arrow keys in the Edit key group.
 - setting range
Compliance range depends on measurement unit. See Chapter 1.
 - default
VAR1 compliance value on the MEASURE: SWEEP SETUP screen

**HOLD
TIME**

- 0.00s** Hold time is displayed on this secondary softkey.
- setting
Press this softkey to display the hold time in the data entry area. Then, you can change the hold time by using the rotary knob, or numeric keys and arrow keys in the Edit key group.
 - setting range : 0 to 655.35 s with 10 ms resolution
 - default : hold time on the MEASURE: SWEEP SETUP screen

**STEP
TIME**

- 0.5ms** Step time is displayed on this secondary softkey. This is the time width of each step.
- setting
Press this softkey to display the step time in the data entry area, then you can change the step time value by using the rotary knob, or numeric keys and arrow keys in the Edit key group.
 - setting range : 0.5 ms to 100 ms with 100 μ s resolution
 - default : 0.5 ms

VAR2 SETUP

Press VAR2 SETUP primary softkey to display secondary softkeys for setting the VAR2 parameters.

If VAR2 is not set for any channel on the CHANNELS: CHANNEL DEFINITION screen, the VAR2 SETUP primary softkey is not displayed.

VAR2 START

20.0 μ A VAR2 start value is displayed on this secondary softkey.

- setting

Press this softkey to display the VAR2 start value in the data entry area. Then, you can change the start value by using the rotary knob, or numeric keys and arrow keys in the Edit key group.

- setting range

Depends on the measurement unit. See Chapter 1.

- default

VAR2 start value on MEASURE: SWEEP SETUP screen

VAR2 STEP

20.0 μ A VAR2 step value is displayed on this secondary softkey.

- setting

Press this softkey to display the VAR2 step value in the data entry area. Then, you can change the start value by using the rotary knob, or numeric keys and arrow keys in the Edit key group.

- setting range

Depends on the measurement unit. See Chapter 1.

- default

VAR2 step value on MEASURE: SWEEP SETUP screen

Measurement Functions
Knob Sweep Function

**VAR2
POINTS**

5 Number of steps is displayed on this secondary softkey.

- setting

Press this softkey to display the VAR2 number of steps in the data entry area. Then, you can change the number of steps by using the rotary knob, or numeric keys and arrow keys in the Edit key group.

- setting range : 1 to 128
- default

VAR2 number of steps on MEASURE: SWEEP SETUP screen

**COMPLI-
ANCE**

2V Compliance value is displayed on this secondary softkey.

- setting

Press this softkey to display the VAR2 compliance value in the data entry area. Then, you can change the number of steps by using the rotary knob, or numeric keys and arrow keys in the Edit key group.

- setting range

Setting range depends on the measurement unit. See Chapter 1.

- default

VAR2 compliance value on MEASURE: SWEEP SETUP screen

CONST SETUP

Select CONST SETUP primary softkey to display the secondary softkeys for setting the constant source parameters. Secondary softkeys for PGUs set to V mode (not VPULSE) are also displayed.

If CONST is not set for any channel on the CHANNELS: CHANNEL DEFINITION screen, the CONST SETUP primary softkey is not displayed.

If more than six constant channels are defined, press the MORE softkey to display softkeys for the other constant channels.

Secondary softkeys for setting constant source parameters

The first line of each secondary softkey displays the variable name of the constant source. The second line displays *force value*. For SMUs, the third line displays *compliance value*. For other units, the third line is blank.

- Example. If an SMU is set as follows, the “Vce 5.00V 10.0mA” softkey appears:
 - Voltage source and current measurement mode.
 - Voltage source name (VNAME): "Vce".
 - Force value: 5.0 V.
 - Compliance value: 10 mA.
- setting
 - source value
Pressing the source name secondary softkey displays the force value in the data entry area. You can change the source value by using the rotary knob, or numeric keys and arrow keys in the Edit key group.
 - compliance value (for SMUs only)
Pressing the source name secondary softkey twice displays the compliance value in the data entry area. You can change the compliance value by using the rotary knob, or numeric keys and arrow keys in the Edit key group.
- setting range
Each setting range depends on the measurement unit. See Chapter 1.

Operation States

The 4155B/4156B has the following four operation states.

- “Idle State”
- “Measurement State”
- “Stress Force State”
- “Standby State”

Idle State

In the idle state, the 4155B/4156B is not doing anything: no measurements, forcing current or voltage, forcing stress.

An 4155B/4156B is in the idle state after applying power. In this state, output switches of all the measurement units are on, and all of the units output 0 V. In this state, you can modify any setting items on the setup screens.

Conditions in the Idle State

The following are the conditions of each unit and accessories in idle state.

SMU	0 V output at 20 V range, and 100 μ A compliance at 100 μ A range
VSU	0 V output at 20 V range
PGU	0 V dc output at 20 V range (output impedance: LOW)
GNDU	0 V output
16441A R-Box	0 Ω is connected.
16440A selector	switching condition is SMU.

Measurement State

In the measurement state, an 4155B/4156B performs sampling or sweep measurements. The output switches are off for units that do *not* have entries in the CHANNELS table of the CHANNELS: CHANNEL DEFINITION screen.

Stress Force State

In the stress force state, the 4155B/4156B outputs ac stress or dc stress according to the settings of the STRESS: STRESS SETUP screen. The output switches are off for units that do *not* have entries in the CHANNELS table of the STRESS: CHANNEL DEFINITION screen.

For channels that are set to ON in the STBY field, the standby values are forced during the stress state. For details of each value, see "Standby State" in this section. So, the STRESS: STRESS SETUP screen settings have no meaning for STBY ON channels. And STBY ON channels cannot be set to SYNC on the STRESS: CHANNEL DEFINITION screen. Must be set to NSYNC.

Measurement Functions
Operation States

Standby State

If the 4155B/4156B is in the standby state, the following occurs depending on the settings in the CHANNELS table of the CHANNELS: CHANNEL DEFINITION screen:

- If STBY field of a unit is set ON, the units output the specified voltage or current. For the output voltage or current in the standby state, see Table 3-4. (VMUs and GNDU cannot be set to ON in the STBY field.)

If both PGUs are set to VPULSE, the STBY settings of both PGUs must be same.
- If unit is enabled, but STBY field is blank, then the unit has following condition.
Voltage range and value:
V force channel outputs 0 V at same range as previous state.
V measure channel keeps same range as previous state.
Current range and value:
I force channel outputs the latest value of previous state. For example, if previous state was measurement state and latest value of VAR1 was stop value, the stop value is output for VAR1 during standby.
I measure channel keeps the latest range of previous state.
- Following settings keep the same conditions as the previous state:
 - output switch of each unit
 - output impedance of PGUs
 - switching condition of the 16440A selector
 - resistance selection of the 16441A R-Box

Unit Conditions in the Standby State

Table 3-4 shows the standby state conditions of the units that are set to ON in the STBY fields. The specified values are the values that are set on the MEASURE setup screens.

Table 3-4

Unit Conditions in the Standby State

FUNCTION	SMU	VSU	PGU
VAR1 VAR1' VAR2	Outputs specified start value. For pulsed mode, specified base value is output.		These functions are not available for PGU.
CONST	Outputs specified source value. For pulsed mode, specified base value is output.	Outputs specified source value.	For V mode, specified source value is output. For VPULSE mode, specified pulsed source is output.

Measurement Functions
Operation States

To Keep Standby State after Getting Setups

To keep standby state after getting setups from a file or an internal memory, *all* of the following must be true. If not, state changes to idle after getting setups.

- STBY ON channel assignments do not change
- MODE and FCTN setups of STBY ON channels do not change
- Following setups of STBY ON channels do not change:

MODE	FCTN			
	CONST	VARI	VAR2	VARI'
V	SOURCE, COMPLIANCE ^a	START, STOP, COMPLIANCE ^a	START, STOP, COMPLIANCE ^a	VARI START ^b , VARI STOP ^b , COMPLIANCE ^a , OFFSET, RATIO
I	SOURCE, COMPLIANCE ^a	START, COMPLIANCE ^a	START, COMPLIANCE ^a	VARI START ^b , COMPLIANCE ^a , OFFSET, RATIO
VPULSE	BASE, PEAK, COMPLIANCE ^a , PGU setups ^c	BASE, START, STOP, COMPLIANCE ^a	BASE, START, STOP, COMPLIANCE ^a	BASE, VARI START ^b , VARI STOP ^b , COMPLIANCE ^a , OFFSET, RATIO
IPULSE	BASE, COMPLIANCE	BASE, COMPLIANCE	BASE, COMPLIANCE	BASE, COMPLIANCE

- a. This parameter is checked for SMUs only.
b. This parameter is checked, even if VARI channel is not standby channel.
c. PGU setups on the MEASURE: PGU SETUP screen.

Output Sequence of Standby Channels

For the following example, the STBY field is set to ON for SMU1, SMU2, PGU1, and PGU2. The STBY field is blank for SMU3 and SMU4.

Figure 3-3

Example of the Output Sequence of the Standby Channels

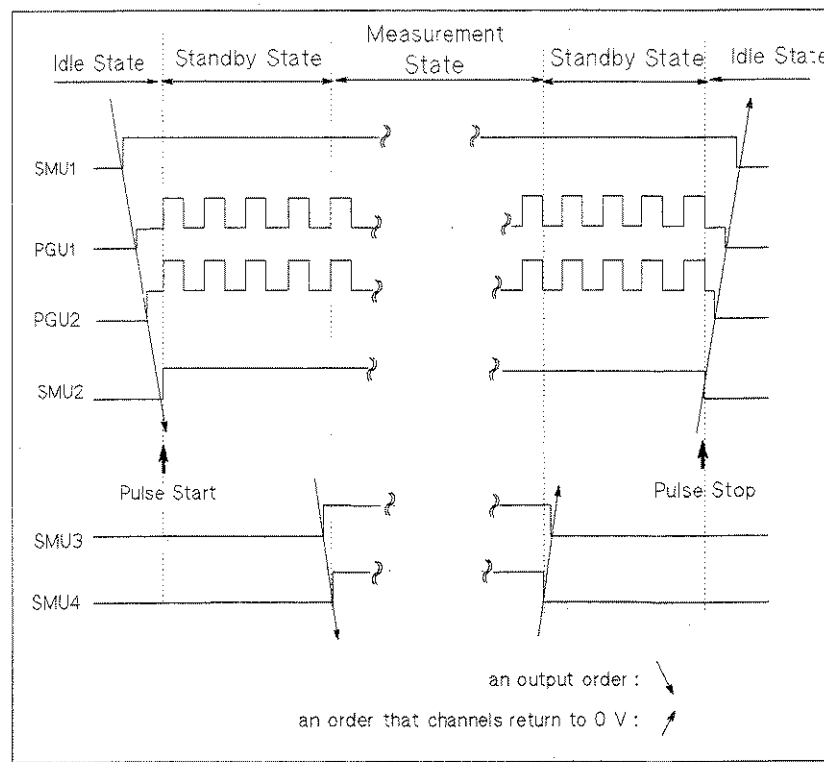

The Standby front-panel key is used to toggle the 4155B/4156B between the standby and idle states.

- In the standby state, the Standby indicator is lit.
When the 4155B/4156B is in the standby state, you can modify setting parameters *only* for units that are *not* set to ON in the STBY fields. If you modify setting parameters of units that are set to ON in the STBY fields, the 4155B/4156B changes from the standby state to the idle state.
- In the idle state, the Standby indicator is off.
If no units are set to ON in the STBY field, the 4155B/4156B cannot be in the standby state.

Measurement Functions
Operation States

Changing among Operation States

Figure 3-4 shows how to change among the operation states.

Figure 3-4

Changing among the Operation States

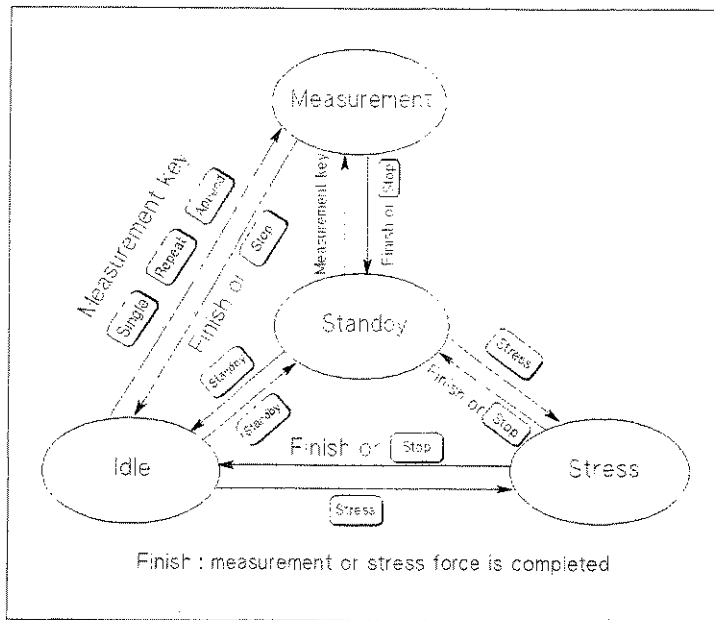

UGD04009

- changing between the idle and measurement/stress states

If you perform measurements or force stress from the idle state, then the 4155B/4156B returns to the idle state after one of the following conditions occurs:

- Measurement is finished.
- Stress is finished.
- Stop front-panel key in the MEASUREMENT key group is pressed.

Measurement Functions Operation States

- changing between the standby and measurement/stress states

If you perform measurements or force stress from the standby state, then the 4155B/4156B returns to the standby state after one of the following conditions occurs:

- Measurement is finished.
- Stress is finished.
- Stop front-panel key in the MEASUREMENT key group is pressed.

If the fixture lid is opened while an SMU is outputting more than ± 40 V, the 4155B/4156B changes to the idle state. If the fixture lid is opened while an SMU is outputting ± 40 V or less, the 4155B/4156B continues in its present state.

Output Sequence

When you perform measurements or force stress, or when you use the standby function, you can specify an output sequence for the source channels.

The 4155B/4156B has two output sequence modes:

- sequential mode

The source channels output in the order that you specify in the OUTPUT SEQUENCE table on the MEASURE: OUTPUT SEQUENCE screen. The source outputs are stopped in the opposite order.

You can set the output sequence to prevent damage to DUTs.

- simultaneous mode (for sampling measurements only)

All the source channels output simultaneously. The source outputs are stopped in the opposite order that you specify in the OUTPUT SEQUENCE table on the MEASURE: OUTPUT SEQUENCE screen.

For details of the OUTPUT SEQUENCE table, refer to “MEASURE: OUTPUT SEQUENCE screen” in Chapter 6.

Sequential Mode

In the sequential mode, the channels start forcing the specified output value according to the order you specify in the OUTPUT SEQUENCE table on the MEASURE: OUTPUT SEQUENCE screen. If you do not specify an order, the default is as follows:

Default output sequence

1. SMU1
2. SMU2
3. SMU3
4. SMU4
5. VSU1
6. VSU2
7. PGU1
8. PGU2

In the idle state, output switches of *all* units are on, and the units output 0 V. For disabled units, the output switches are turned off before the source units output the specified source value. "Disabled" means that the entries for the unit are blank in the CHANNELS table of the CHANNEL DEFINITION screen. There is no rule for the sequence of turning the output switches off.

For example, if SMU4 and VSU2 are disabled, default output sequence is:

1. Output switches of SMU4 and VSU2 are turned off
2. SMU1
3. SMU2
4. SMU3
5. VSU1
6. PGU1
7. PGU2

Sequence for returning to 0 V

When returning to the idle state, the outputs of the enabled units are returned to 0 V in opposite order that forcing occurred. Then the output switches of the disabled units set are turned on.

Measurement Functions
Output Sequence

Example

Figure 3-5 shows an example of using the default output sequence.

In Figure 3-5, assumptions are:

- Configuration of the units is 4 SMUs and 2 VSUs.
- SMU4 and VSU2 are disabled.
- Default output sequence is used.

Figure 3-5

Default Output Sequence Example for the Sequential Mode

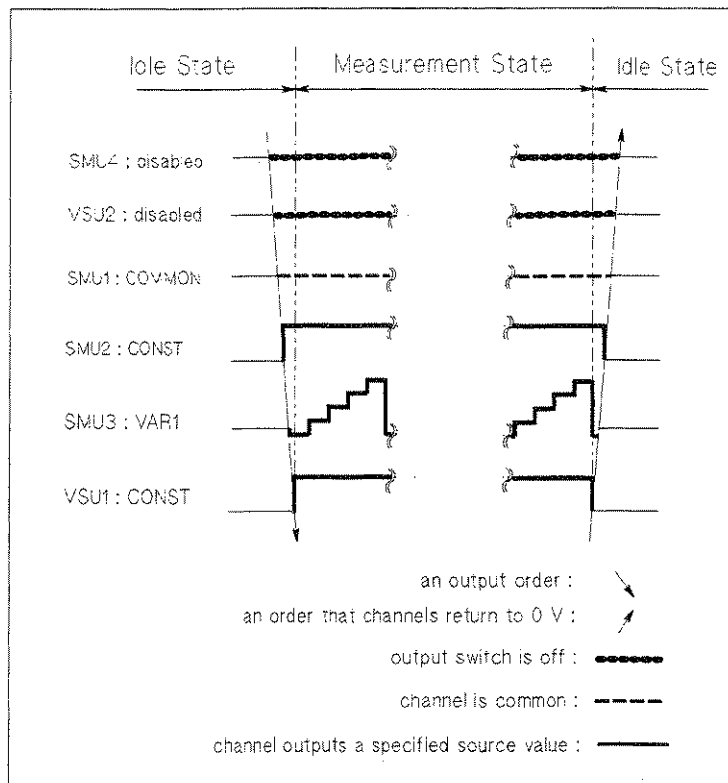

UGD04010

Output sequence (idle state to other state)

"Other state" means the measurement, stress force, or standby state. In Figure 3-5, the 4155B/4156B first turns off output switches of SMU4 and VSU2, then outputs in the following order:

1. SMU1
2. SMU2
3. SMU3
4. VSU1

Sequence for returning to 0 V (other state to the idle state)

The order for returning to 0 V is:

1. VSU1
2. SMU3
3. SMU2
4. SMU1

Then, the output switches of SMU4 and VSU2 are turned on, and the units output 0 V.

For a stress sequence example, see Figure 3-1. For a standby sequence example, see Figure 3-3.

Measurement Functions
Output Sequence

Simultaneous Mode

The simultaneous mode is allowed *only* when you select the sampling measurement mode in the MEASUREMENT MODE field on the CHANNELS: CHANNEL DEFINITION screen.

In the simultaneous mode, all enabled units start the specified outputs at the same time. For disabled units, refer to description in “Sequential Mode” on page 3-39.

The order of returning the outputs to 0 V is *not* simultaneous, but is the opposite order of the OUTPUT SEQUENCE table on the MEASURE: OUTPUT SEQUENCE screen. Refer to description in “Sequential Mode” on page 3-39.

Example

Figure 3-6 shows an example of the output sequence when you select the simultaneous mode.

Figure 3-6

Default Output Sequence Example for the Simultaneous Mode

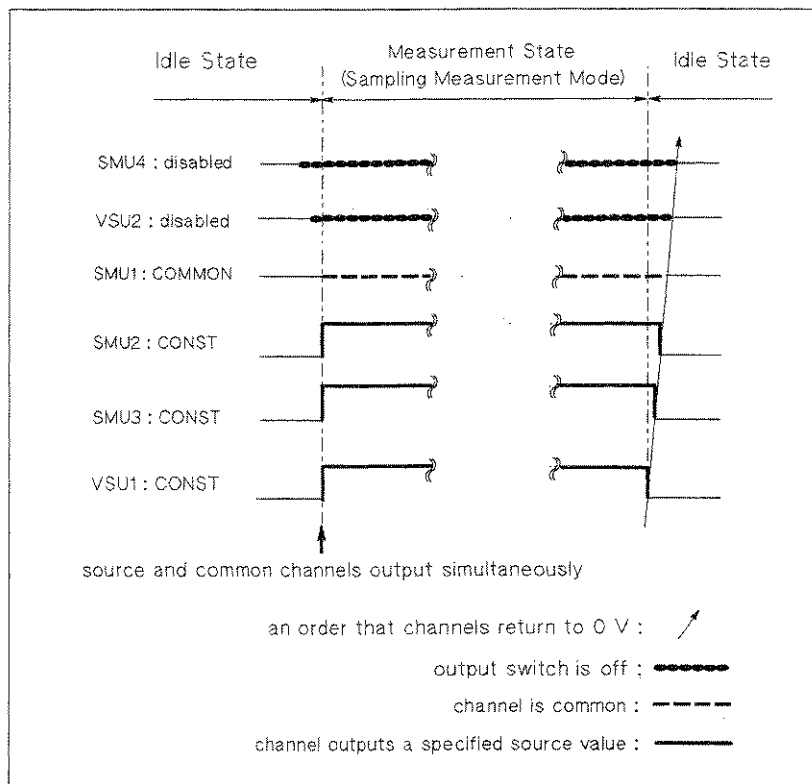

UGD04011

Measurement Functions Output Sequence

In Figure 3-6, assumptions are:

- Configuration of the units is 4 SMUs and 2 VSUs.
- SMU4 and VSU2 are disabled.
- Default settings are used for OUTPUT SEQUENCE table, which determines the return to 0 V sequence.

Output sequence (idle state to the measurement state)

In Figure 3-6, when the state changes from the idle state to the measurement state, the output switches of SMU4 and VSU2 are turned off. Then, all of the source channels (SMU1, SMU2, SMU3, and VSU1) force the specified source value simultaneously.

Sequence for returning to 0 V (measurement state to the idle state)

The order for returning to 0 V is:

1. VSU1
2. SMU3
3. SMU2
4. SMU1

Then the output switches of SMU4 and VSU2 are turned on, and the units output 0 V.

Trigger Function

The 4155B/4156B can perform measurements synchronized with external instruments, such as external power supplies, capacitance meters, precision voltmeters/ammeters, probers, and handlers, via the trigger input and trigger output terminals.

Connection

The following figure shows the connection between an 4155B/4156B and an external instrument.

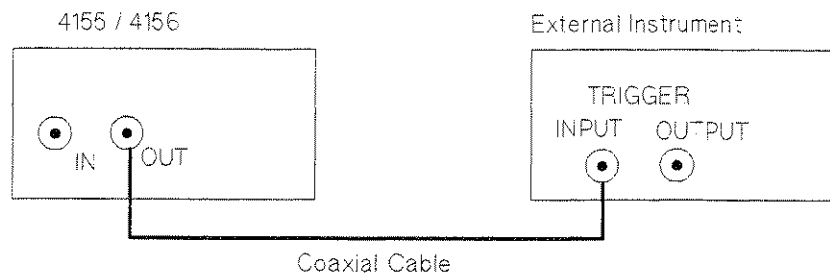

(a) For Trigger Output Function

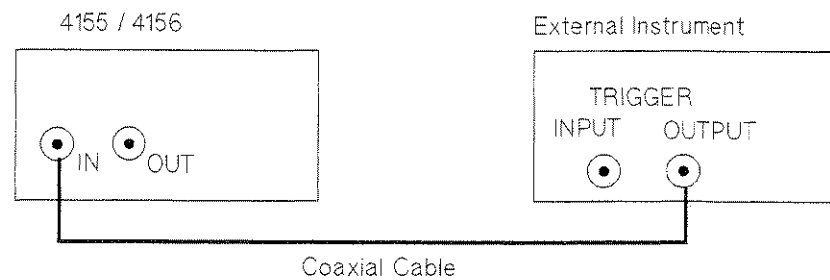

(b) For Trigger Input Function

Measurement Functions Trigger Function

Setup and restrictions

- You *cannot* perform trigger outputs together with trigger inputs. You *must* select either trigger output or trigger input.
- To use a trigger function, you must enable the trigger function and select either TRIG OUT or TRIG IN in the TRIGGER SETUP table on the MEASURE: OUTPUT SEQUENCE screen. Then the trigger inputs or outputs are performed automatically after you start a measurement by selecting a measurement front-panel key (Single, Repeat, or Append). For details of the MEASURE: OUTPUT SEQUENCE screen, refer to “MEASURE: OUTPUT SEQUENCE screen” in Chapter 6.
- The *trigger output* function is *not* available for sampling measurements.
- When you perform knob sweep measurements, the trigger function is not available.
- For the electrical specifications of trigger signals, refer to Chapter 8 of *User's Guide General Information*.

Measurement Functions
Trigger Function

Externally Triggered Sampling or Sweep Measurement

The 4155B/4156B can receive an edge trigger from external instruments via the trigger input terminal, and initiate a sweep or sampling measurement. Following figure shows examples of externally-triggered sampling and sweep measurements. For the trigger polarity, you can select positive or negative.

Figure 3-7

Examples of Externally Triggered Measurements

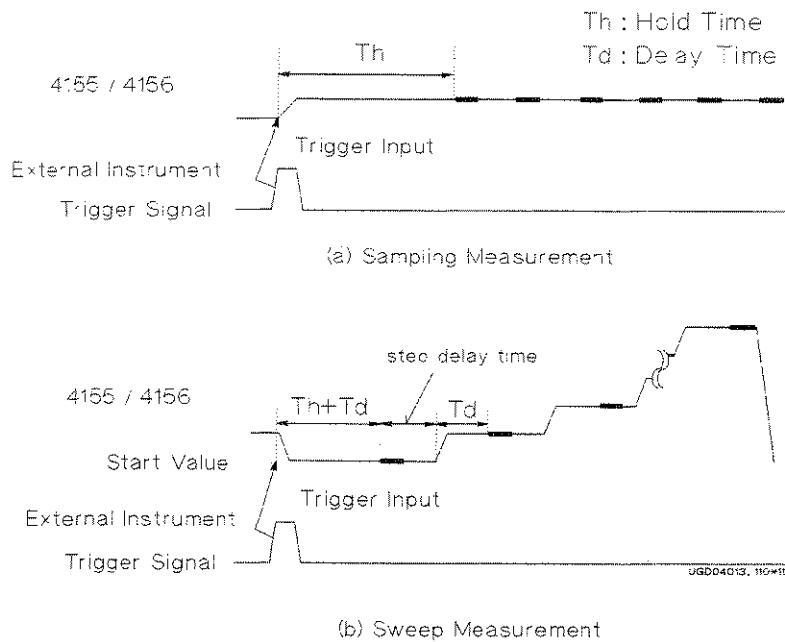

After you press a measurement front-panel key, the 4155B/4156B receives the trigger signal *only once*. So, even if you select Repeat key, the 4155B/4156B receives the trigger signal only once, then repeats measurements.

For *staircase* sweep measurements, you can specify the step delay time shown in Figure 3-7.

Triggering an External Instrument

The 4155B/4156B triggers external instruments via the trigger output terminal. For the trigger polarity, you can select positive or negative. The trigger output function is *not* available for sampling measurements.

Gate Trigger Output for Stress Force

In the stress force state, the 4155B/4156B can output gate triggers. The 4155B/4156B outputs a gate trigger while stress channels are forcing stress.

When stress forcing starts, the trigger signal changes to the active level. When stress forcing finishes, the trigger signal changes to the non-active level.

To use the gate trigger function, set the TRIGGER SETUP fields on the STRESS: CHANNEL DEFINITION screen.

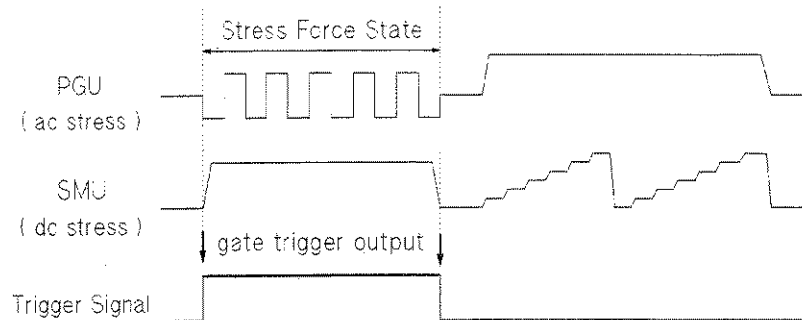

Edge Trigger Output for Sweep Measurement

For sweep measurements, the 4155B/4156B can output edge triggers, which are synchronized with each sweep step.

When you set pulse sweep measurement, the TRIG OUT DELAY field is displayed in the third column of the TRIGGER SETUP table on the MEASURE: OUTPUT SEQUENCE screen.

When you set staircase sweep measurement, the STEP DELAY field is displayed in the third column of the TRIGGER SETUP table on the MEASURE: OUTPUT SEQUENCE screen.

Measurement Functions
Trigger Function

Trigger output delay time for pulse sweep measurements.

When using an SMU as a pulse source, the 4155B/4156B can output edge triggers at each pulse leading edge. Trigger output delay time specifies how much to delay the trigger after the leading edge. So, you set the trigger output delay time to wait until the 4155B/4156B outputs a stable pulse peak value. Trigger output delay time is shown as T1 in the following figure.

The setting range of T1 is from 0 s to the specified pulse width or 32.7 ms, whichever is shorter. The setting resolution of T1 is 100 μ s .

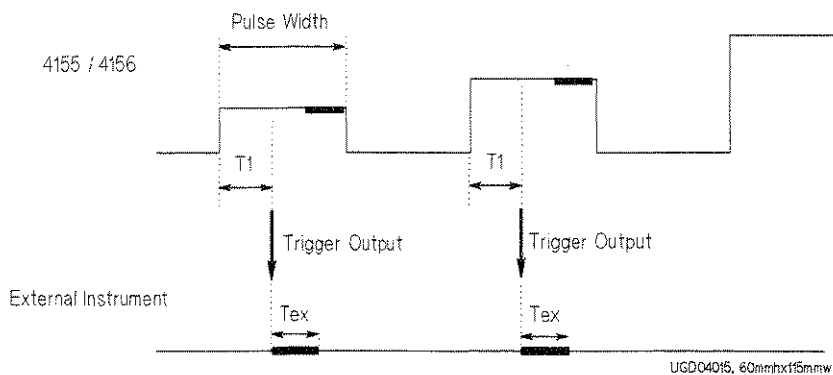

T1 : trigger output delay time
(set in TRIG OUT DELAY field on MEASURE: OUTPUT SEQUENCE page)
Tex : measurement time for external instrument

If you want the external instruments to make a measurement while the pulse peak value is being forced, the specified T1 and pulse width must satisfy the following equation: $pulse\ width > T1 + Tex$

Measurement Functions
Trigger Function

Step delay time for staircase sweep measurements.

When performing sweep measurements without a pulsed SMU, the 4155B/4156B outputs an edge trigger at the time when the 4155B/4156B starts performing measurement in each sweep step as shown in the following figure.

The step delay time you specify for trigger is the time from when the trigger is output to when the next step occurs. This is to make sure the external instrument has enough time to make the measurement. The step delay time is shown as T2 in the following figure. You can set T2 from 0 to 1 s with 100 μ s resolution.

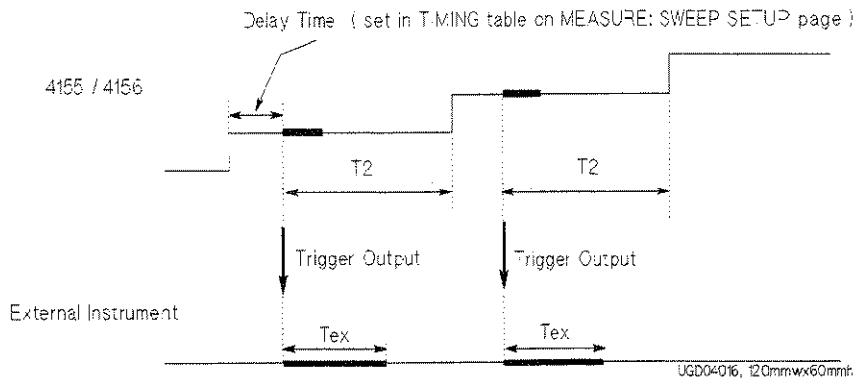

T2 : step delay time (set in STEP DELAY field on MEASURE: OUTPUT SEQUENCE page)

Tex : measurement time for external instrument

If the specified T2 is shorter than the measurement time of the 4155B/4156B, the 4155B/4156B waits until the measurement completes, then outputs the next step.

Measurement Functions

Trigger Function

Trigger output function of PGU.

If the 41501A/B contains PGUs, the PGUs can output a gate trigger through the 41501A/B trigger output terminal to external pulse generators. The trigger signal is output automatically when PGUs output pulses. You cannot control this function. This function allows you to perform measurements in which external pulse generators are synchronized with the 41501A/B PGUs.

You can use this function if you need more than two *ac* stress source channels.

The following figure shows the trigger signal.

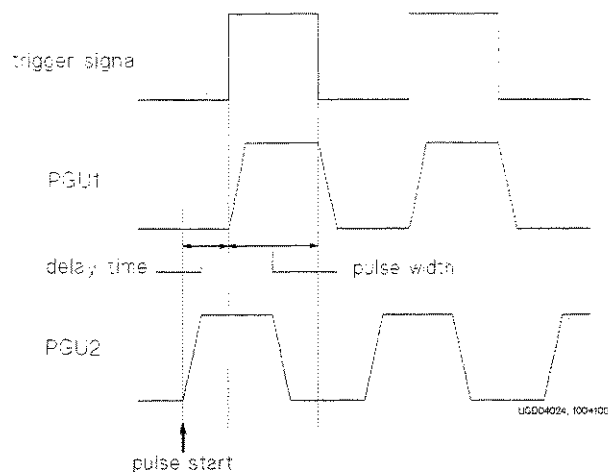

The leading-edge and trailing-edge of the trigger are synchronized with the leading-edge and trailing-edge of PGU1. The polarity of the trigger is positive and the output level is TTL.

R-BOX Control

The 16441A R-Box adds series resistance between SMU output and DUT. This prevents excessive current from flowing and damaging the DUT when sudden voltage change occurs at the DUT.

SMUs cannot measure negative resistance. You need to connect resistance between SMU and DUT if you want to measure negative resistance characteristics.

So the 16441A R-Box is useful for:

- breakdown characteristics measurement.
- negative resistance measurement.

You can connect a maximum of two SMU channels to the 16441A.

There are the limitations on measurement with the 4155B/4156B and R-Box:

- If you measure device characteristics including negative resistance over 1 M Ω with the 4155B/4156B and R-Box, there is a possibility that they cannot measure it.
- There is a possibility that the 4155B/4156B cannot perform measurement circumstances.

The 4155B/4156B automatically compensates for voltage drop of the series resistance value. So, the GRAPH/LIST screen group show the compensated data.

The LEDs on the 16441A R-Box indicate the currently connected resistance value.

For details of the 16441A R-Box, refer to *Agilent 16441A R-Box User's Guide*.

Resistance Value

The following resistance values are selectable for each channel.

- 1 M Ω
- 100 k Ω
- 10 k Ω
- 0 Ω

If you want to use Kelvin connections for HRSMUs or HPSMUs, you must select 0 Ω . You cannot use Kelvin connections for other resistances.

Measurement Functions

R-BOX Control

For the following SMUs, you can set 0 Ω *only*:

- SMU that is set to ON in the STBY field
- SMU that is set to COMMON in the MODE field

If the 4155B/4156B is on and an emergency occurs, the resistance value changes to 1 M Ω .

Setups

You set resistance values in the SERIES RESISTANCE column on the CHANNELS: CHANNEL DEFINITION screen.

You can set resistance values for the following SMUs.

- SMU1 (to CH1 terminal of R-Box)
- SMU2 (to CH2 terminal of R-Box) if the 41501A/B SMU/Pulse Generator Expander is not installed or does not have an HPSMU
- SMU5 (to CH2 terminal of R-Box) if the 41501A/B is installed and has an HPSMU

If you connect the 16441A R-Box to the SMUs described above, the 4155B/4156B automatically compensates for voltage drop of the resistance values. So, if the variables are used on GRAPH/LIST screen or in a user function, the values are the compensated values.

NOTE

If you connect the 16441A R-Box to SMUs other than described above, resistance values are not compensated for automatically. You need to compensate for the resistance values manually, such as by using a user function or calculation in the Instrument BASIC program.

NOTE

Be aware that an additional measurement channel is automatically used if *both* the following are true:

- You *force voltage* from channel that is connected to R-Box, and
- You display this voltage variable on graph/list, or use voltage variable in user function.

Additional channel is used because the current is automatically measured. Current value is necessary to perform compensation calculation.

Circuit Diagram

Figure 3-8 shows a simplified circuit diagram of an 16441A R-Box.

Figure 3-8 Simplified Circuit Diagram of the 16441A R-Box

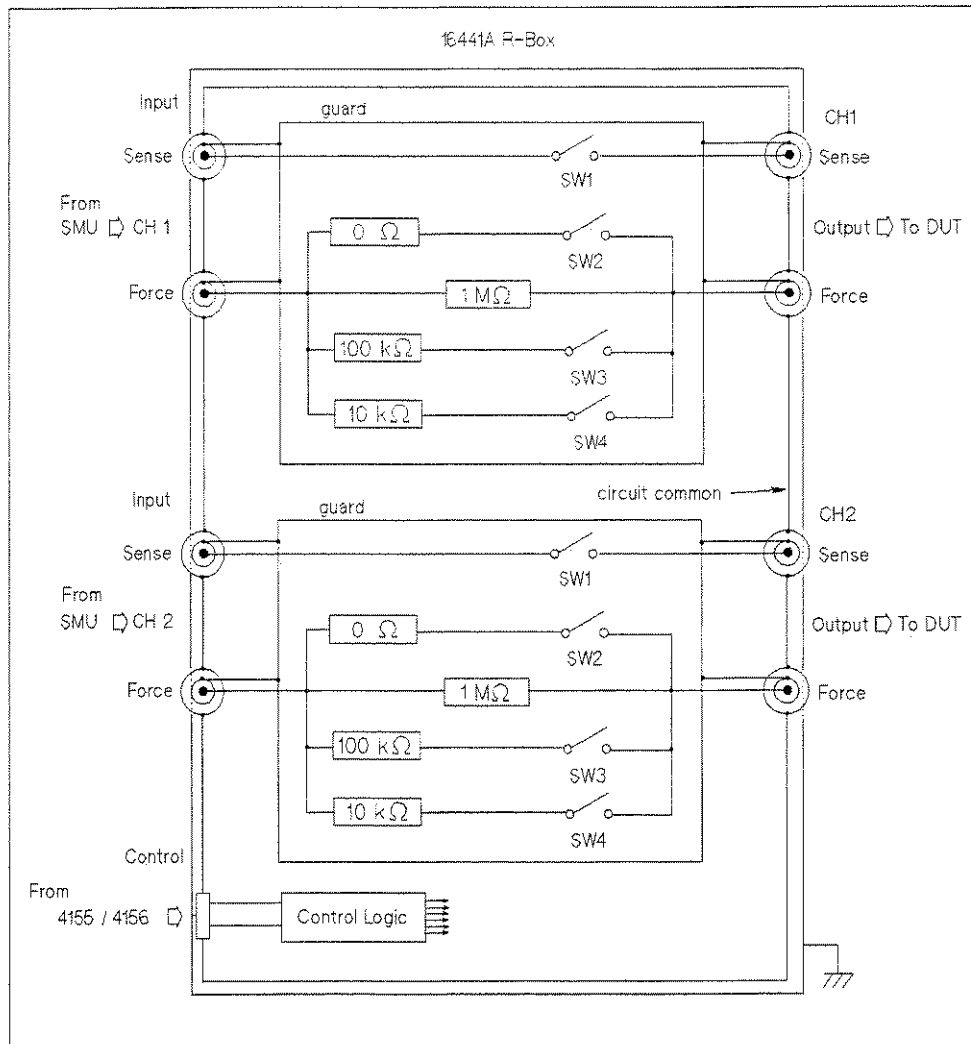

Measurement Functions
R-BOX Control

Table 3-5 shows switching conditions for each setting.

Table 3-5

Switching Conditions of the 16441A R-Box

Settings	Switches			
	SW1	SW2	SW3	SW4
0 Ω	ON	ON	OFF	OFF
10 k Ω	OFF	OFF	OFF	ON
100 k Ω	OFF	OFF	ON	OFF
1 M Ω	OFF	OFF	OFF	OFF

Resistance is switched before and after measurement state. In the standby state, the stress state, and the idle state, 0 Ω is connected.

Connections

Table 3-6 is the parts list of cables for connecting the 16441A R-Box.

Table 3-6

Parts List of Cables for Connecting the 16441A

Agilent Model or Part Number	Description
04155-61610	Control Cable 1.5 m
04155-61609	Control Cable 3.0 m
04155-61605	Triaxial Cable 0.4 m
16493K #001	Kelvin Triaxial Cable 1.5 m
16493K #002	Kelvin Triaxial Cable 3.0 m

If you want to use Kelvin connections for HRSMUs and HPSMUs, you must set 0 Ω in the SERIES RESISTANCE column on the CHANNELS: CHANNEL DEFINITION screen.

Kelvin Connections

The following figure shows the 16441A R-Box connections using Kelvin connections.

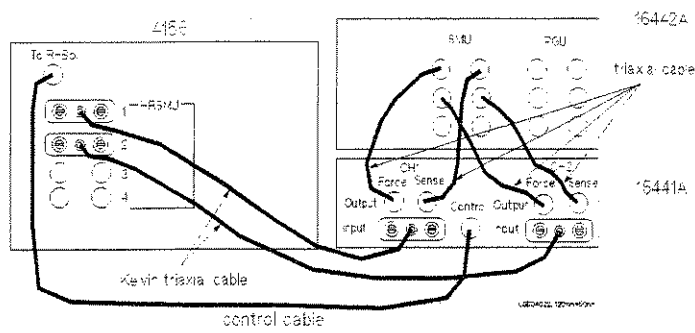

Non-Kelvin Connections

The following figure shows the 16441A R-Box connections using non-Kelvin connections.

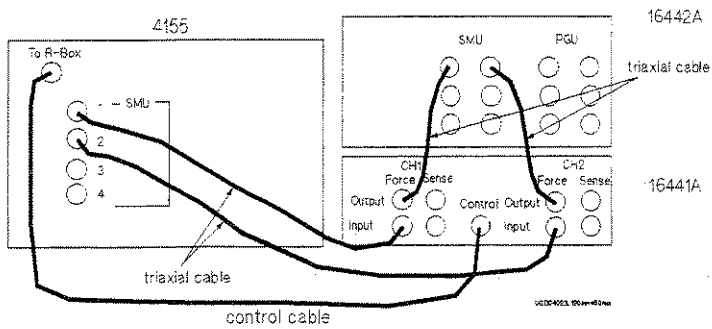

Measurement Ranging Mode

The 4155B/4156B provides the following four measurement ranging modes:

- auto ranging
- limited auto ranging
- fixed range
- compliance range

You can choose the ranging modes for each measurement channel.

The following table lists the allowable measurement ranging modes for each measurement mode and measurement function.

Table 3-7

Allowable Measurement Ranging Modes

Measurement Mode/Function	Auto Ranging	Limited Auto Ranging	Compliance Range	Fixed Range
Sweep Measurement	yes	yes		yes
Sampling Measurement (Initial Interval ^a ≥ 2 ms)	yes	yes		yes
Sampling Measurement (Initial Interval < 2 ms)				yes
Knob Sweep			yes	

- a. You specify initial interval on the MEASURE: SAMPLING SETUP screen.

If you choose sweep measurement or sampling measurement (initial interval ≥ 2 ms) and you do not set a ranging mode, auto ranging is set for V mode channel and limited auto (InA) ranging is set for I mode channel automatically.

For sampling measurement (initial interval < 2 ms), an error occurs if fixed range is not set.

Auto Ranging

The monitor unit searches for and measures at the range that provides the highest resolution as follows:

- V measurement

The unit changes ranges (up or down one range at a time) until the measurement value is between 10% and 110% of the range, then the unit performs the measurement.

- I measurement

- 1 A to 1 μ A

The unit changes ranges (up or down one range at a time) until the measurement value is between 10% and 114% of the range, then the unit performs the measurement.

If the measurement value is less than 1 % of the present range and the present range is 100 μ A or higher range, the range changes down two ranges instead of one range.

- 100 nA to 100 pA

The unit changes ranges (up or down one range at a time) until the measurement value is between 10% and 114% of the range, then the unit performs the measurement.

- 10 pA

The unit changes to the next higher range when the measurement value exceeds 104 % of the present range.

Measurement Functions
Measurement Ranging Mode

Limited Auto Ranging

You specify a range, which is the lowest possible range at which you want to measure. For V measurement, if the specified range is greater than the lowest range that contains V compliance, the measurement is performed at the compliance range. For I measurement, if specified range is greater than the lowest range that includes I compliance, an error occurs.

Measurement time for Limited Auto ranging is less than for Auto ranging because unit does not search below specified range, thus reducing number of range changes. So, specify highest range that gives you satisfactory results.

Monitor unit searches for and measures at measurement range that provides highest resolution (but is not below the specified range) as follows:

- V measurement

The unit changes ranges (up or down one range at a time, but not below specified range) until the measurement value is between 10% and 110% of the range, then the unit performs the measurement.

- I measurement

- 1 A to 1 μ A

The unit changes ranges (up or down one range at a time, but not below specified range) until the measurement value is between 10% and 114% of the range, then the unit performs the measurement.

If the measurement value is less than 1 % of the present range, and if present range is 100 μ A or higher range, and if the present range is two or more ranges above the specified range, the range changes down two ranges instead of one range.

- 100 nA to 100 pA

The unit changes ranges (up or down one range at a time, but not below specified range) until the measurement value is between 10% and 114% of the range, then the unit performs the measurement.

- 10 pA

The unit changes to the next higher range when the measurement value exceeds 104% of the present range.

Compliance Range

Compliance range is available for knob sweep measurement only.

- V measurement

The monitor unit measures at the lowest range that includes V compliance.

For VMUs, compliance range is automatically set as follows.

grounded mode 20 V

differential mode 20 V

- I measurement

The monitor unit measures at the lowest range that includes I compliance.

For details about setting compliance, refer to “Compliance” on page 3-60.

Fixed Range

The monitor unit measures at the specified range only.

For current measurement, if specified range is greater than the lowest range that includes I compliance, an error occurs.

Compliance

Allowable units:

HPSMU, MPSMU, HRSMU

To prevent damage to the test device due to overcurrent, overvoltage, or overpower, you can set current compliance, voltage compliance, or power compliance for the HPSMU, MPSMU, and HRSMU.

Voltage and Current Compliance

Voltage compliance (V compliance) and current compliance (I compliance) are limiters that can be set with the same resolution and accuracy as output current or output voltage. For V/I compliance setting range, refer to Table 3-8 and Table 3-9. For V/I compliance resolution, refer to Table 3-10 and Table 3-11.

When a unit reaches I compliance, the unit acts as a constant I source. When a unit reaches V compliance, the unit acts as a constant V source.

- setting and restrictions

- V source mode channel

- When using a unit in the V source mode, specify I compliance.

- I source mode channel

- When using a unit in the I source mode, specify V compliance.

- VSU

- For VSU, current compliance is automatically set to approximately ± 100 mA. You cannot change it.

- common channel

- If you set COMMON measurement mode for the unit, then I compliance for the unit is automatically set as follows and you cannot change the setting.

GNDU	1.6 A
HRSMU	105 mA
MPSMU	105 mA
HPSMU	1 A

- polarity and output area

- V compliance

The 4155B/4156B automatically sets V compliance polarity to the same polarity as the output current, regardless of the specified V compliance polarity. There is no compliance for the opposite polarity.

- I compliance

The 4155B/4156B automatically sets I compliance for both the positive and negative polarity, regardless of the I compliance polarity.

However, if the output voltage and output current are opposite polarity, the $|I\ compliance|$ value is increased by an amount that is 2.5% to 12% of the range value in the lowest range that includes $I\ compliance$. The following figure shows the relation of the compliance and output.

Figure 3-9 Relation of Compliance and Output

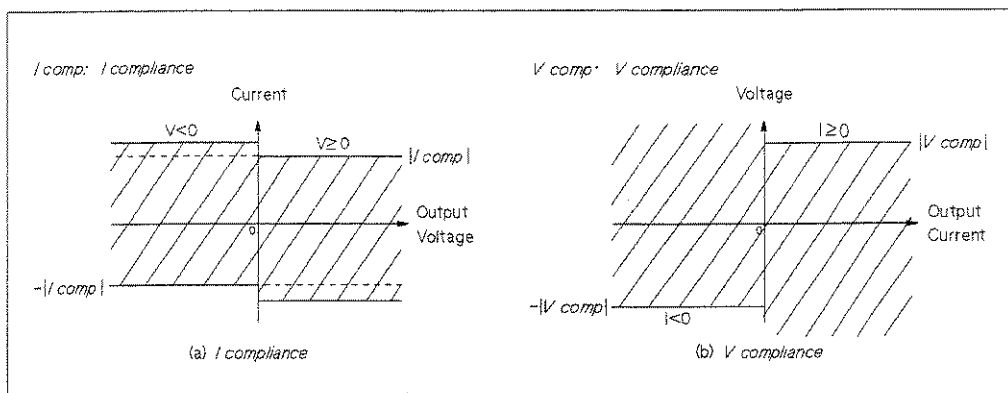

UGD04017

Measurement Functions
Compliance

The following tables list the compliance setting range and compliance resolution.

Table 3-8

V Compliance Setting Range

Unit	Output Range	V Compliance Setting Range
HRSMU	10 pA to 10 mA	0 to 100 V
	100 mA ($0 \leq I \leq 20$ mA)	0 to 100 V
	100 mA (20 mA $< I \leq 50$ mA)	0 to 40 V
	100 mA (50 mA $< I \leq 100$ mA)	0 to 20 V
MPSMU	1 nA to 10 mA	0 to 100 V
	100 mA ($0 \leq I \leq 20$ mA)	0 to 100 V
	100 mA (20 mA $< I \leq 50$ mA)	0 to 40 V
	100 mA (50 mA $< I \leq 100$ mA)	0 to 20 V
HPSMU	1 nA to 10 mA	0 to 200 V
	100 mA ($0 \leq I \leq 50$ mA)	0 to 200 V
	100 mA (50 mA $< I \leq 115$ mA)	0 to 100 V
	1 A ($0 \leq I \leq 50$ mA)	0 to 200 V
	1 A (50 mA $< I \leq 125$ mA)	0 to 100 V
	1 A (125 mA $< I \leq 500$ mA)	0 to 40 V
	1 A (500 mA $< I \leq 1$ A)	0 to 20 V

Measurement Functions
Compliance

Table 3-9 I Compliance Setting Range

Unit	Output Range	I Compliance Setting Range
HRSMU	2 V	100 fA to 100 mA
	20 V	100 fA to 100 mA
	40 V	100 fA to 50 mA
	100 V	100 fA to 20 mA
MPSMU	2 V	1 pA to 100 mA
	20 V	1 pA to 100 mA
	40 V	1 pA to 50 mA
	100 V	1 pA to 20 mA
HPSMU	2 V	1 pA to 1000 mA
	20 V	1 pA to 1000 mA
	40 V	1 pA to 500 mA
	100 V	1 pA to 125 mA
	200 V	1 pA to 50 mA

Table 3-10 V Compliance Resolution

Unit	V Compliance	Resolution
HRSMU	$0 \text{ V} \leq V \leq 2 \text{ V}$	100 μV
MPSMU	$2 \text{ V} < V \leq 20 \text{ V}$	1 mV
HPSMU	$20 \text{ V} < V \leq 40 \text{ V}$	2 mV
	$40 \text{ V} < V \leq 100 \text{ V}$	5 mV
	$100 \text{ V} < V \leq 200 \text{ V}$	10 mV

Measurement Functions
Compliance

Table 3-11

I Compliance Resolution

Unit	I Compliance	Resolution
HRSMU	$100 \text{ fA} \leq I \leq 100 \text{ pA}$	10 fA
	$100 \text{ pA} < I \leq 1 \text{ nA}$	100 fA
	$1 \text{ nA} < I \leq 10 \text{ nA}$	1 pA
	$10 \text{ nA} < I \leq 100 \text{ nA}$	10 pA
	$100 \text{ nA} < I \leq 1 \text{ }\mu\text{A}$	100 pA
	$1 \text{ }\mu\text{A} < I \leq 10 \text{ }\mu\text{A}$	1 nA
	$10 \text{ }\mu\text{A} < I \leq 100 \text{ }\mu\text{A}$	10 nA
	$100 \text{ }\mu\text{A} < I \leq 1 \text{ mA}$	100 nA
	$1 \text{ mA} < I \leq 10 \text{ mA}$	1 μA
	$10 \text{ mA} < I \leq 100 \text{ mA}$	10 μA
MPSMU	$1 \text{ pA} \leq I \leq 1 \text{ nA}$	100 fA
	$1 \text{ nA} < I \leq 10 \text{ nA}$	1 pA
	$10 \text{ nA} < I \leq 100 \text{ nA}$	10 pA
	$100 \text{ nA} < I \leq 1 \text{ }\mu\text{A}$	100 pA
	$1 \text{ }\mu\text{A} < I \leq 10 \text{ }\mu\text{A}$	1 nA
	$10 \text{ }\mu\text{A} < I \leq 100 \text{ }\mu\text{A}$	10 nA
	$100 \text{ }\mu\text{A} < I \leq 1 \text{ mA}$	100 nA
	$1 \text{ mA} < I \leq 10 \text{ mA}$	1 μA
	$10 \text{ mA} < I \leq 100 \text{ mA}$	10 μA
	HPSMU	$1 \text{ pA} \leq I \leq 1 \text{ nA}$
$1 \text{ nA} < I \leq 10 \text{ nA}$		1 pA
$10 \text{ nA} < I \leq 100 \text{ nA}$		10 pA
$100 \text{ nA} < I \leq 1 \text{ }\mu\text{A}$		100 pA
$1 \text{ }\mu\text{A} < I \leq 10 \text{ }\mu\text{A}$		1 nA
$10 \text{ }\mu\text{A} < I \leq 100 \text{ }\mu\text{A}$		10 nA
$100 \text{ }\mu\text{A} < I \leq 1 \text{ mA}$		100 nA
$1 \text{ mA} < I \leq 10 \text{ mA}$		1 μA
$10 \text{ mA} < I \leq 100 \text{ mA}$		10 μA
$100 \text{ mA} < I \leq 1 \text{ A}$		100 μA

Power Compliance

In addition to V compliance or I compliance, you can set power compliance for the VAR1, VAR2, and VAR1' channels of sweep measurement. If the pulse output function is used for VAR1 or VAR1' channels, you *cannot* set power compliance for the VAR1 or VAR1' channel that is set to pulse output. You can set it for the other channels.

The power compliance setting range for each SMU is as follows:

HRSMU	1 to 2 W
MPSMU	1 to 2 W
HPSMU	1 to 20 W

If you specify I compliance and power compliance for a V sweep source, the 4155B/4156B changes the I compliance at every voltage step. The I compliance is set to the smaller value of *I compliance* and *power compliance/step voltage*, as shown in the following figure (a).

If you specify V compliance and power compliance for an I sweep source, the 4155B/4156B changes the V compliance at every current step. The V compliance is set to the smaller value of *V compliance* and *power compliance/step current* as shown in figure (b).

Figure 3-10 Power Compliance Output Area

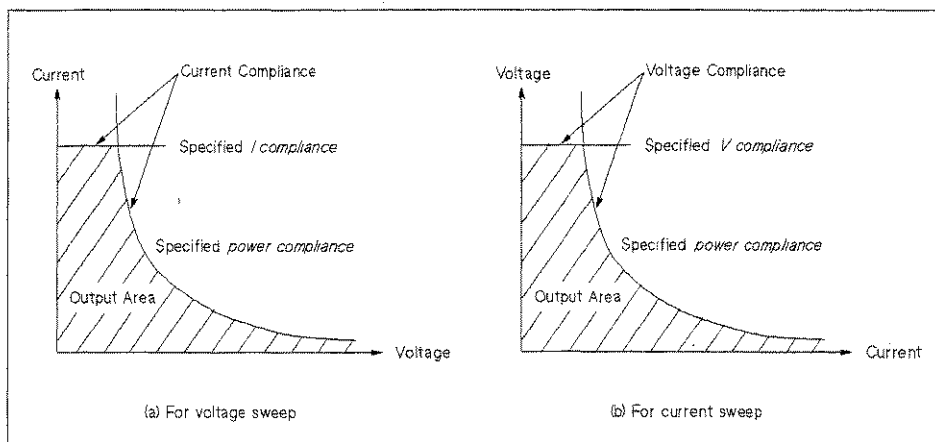

UGD04018

Measurement Functions Compliance

If you specify power compliance, SMUs can be swept at their maximum output limits because the 4155B/4156B changes the V output range and I compliance range during a V sweep and changes the I output range and V compliance range during an I sweep. The following figure shows an example of the difference in SMU output when power compliance is set and when power compliance is not set.

Figure 3-11

Allowable I Output when the MPSMU Sweeps Voltage (0 V to 100 V)

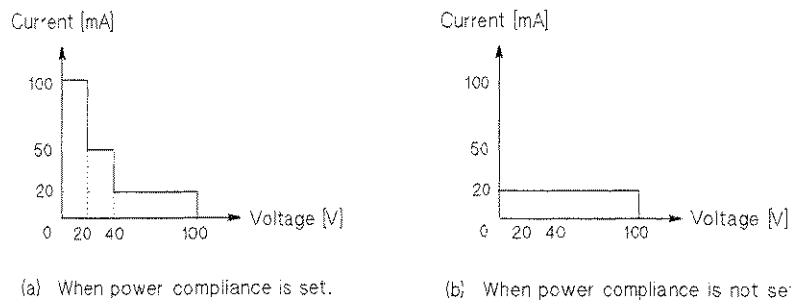

If you specify power compliance, the measurement time increases slightly because of the range changing for every step.

When the ranges are changed during a sweep to accommodate power compliance, the SMU output is momentarily set to 0 V.

Integration Time

To reduce measurement errors caused by line frequency noise or any other environmental noise source, the 4155B/4156B takes a number of measurement samples and averages them to obtain a measurement data. The number of measurement samples taken during each measurement depends on integration time. Setting a longer integration time increases the number of measurement samples, so you can get more accurate measurement data. Integration time is divided into three categories:

- short
- medium
- long

To perform high-speed measurements, set integration time to short. To perform more accurate measurements, set integration time to long.

All measurement units are set to the same integration time that is specified in the INTEG TIME table on the MEASURE: MEASURE SETUP screen. For details of the INTEG TIME table, see “MEASURE: MEASURE SETUP screen” in Chapter 6.

Short

Short integration time is effective when you need high-speed measurements. But the measurement data have lower resolution.

You set the short integration time by pressing the Short front-panel key, then you can enter integration time from 80 μ s to 1.92 ms with 80 μ s resolution in the INTEG TIME table on the MEASURE: MEASURE SETUP screen. The initial setting for short integration time is 640 μ s.

Basically, the measurement units measure with specified integration time. But if both of the following conditions are satisfied, the units may measure with longer integration time than specified:

- Settings of integration time: 0.64 ms to 1.92 ms
- Measurement range: 10 pA to 10 μ A range

Measurement Functions
Integration Time

Medium

Medium integration time is 1 PLC (power line cycle). You set the medium integration time by pressing the Medium front-panel key. The medium integration time depends on the power line cycle. (For example, if power line cycle is 50 Hz, medium integration time is 20 ms.) You cannot modify the medium integration time.

If you measure current in the 1 nA or lower ranges by using SMUs, integration time of SMUs is automatically changed as follows:

Table 3-12

Actual Medium Integration Time of SMUs (≤ 1 nA range)

Measurement Unit	Measurement Range	Integration Time
HRSMU	10 pA	50 PLC
	100 pA	10 PLC
	1 nA	5 PLC
MPSMU	1 nA	3 PLC
HPSMU	1 nA	3 PLC

Long

Long integration time is effective when you need high resolution and noise reduction measurement. But the measurement speed is slow. You set the integration time by pressing the Long front-panel key, then you can enter the integration time from 2 PLC to 100 PLC with 1 PLC resolution in INTEG TIME table on MEASURE: MEASURE SETUP screen. Initial setting for long integration time is 16 PLC.

When an 4155B/4156B measures current in 1 nA or lower ranges by using HRSMU, integration time of HRSMU is automatically changed to longer integration time (maximum 100 PLC) than specified.

SMU Filter

You can set SMU filter to on or off for sampling measurements or stress forcing. If filter is *on*, noise and overshoot are decreased, but settling time takes longer.

- sampling measurement

You set the FILTER field on the MEASURE: SAMPLING SETUP screen.

If you set initial interval to a short time, and if filter is set to ON, be aware that settling time takes several ms.

- stress force

You set the FILTER field on the STRESS: STRESS SETUP screen.

If you set dc stress to short stress force time, set OFF in this field if you want the stress signal to be more pulsed shaped.

NOTE

Filter Condition for Sweep Measurement

When you perform sweep measurements, the SMU filter conditions are automatically set as follows:

For a pulsed SMU Filter is *off*.

For non-pulsed SMUs Filters are *on*.

Zero Offset Cancel

The 4155B/4156B has zero offset cancel function. This function measures the zero offset data when green key, then Stop key is pressed. Then, uses this data to compensate the measurement results when measurement is performed.

So, the offset cancel function allows you to minimize measurement error caused by undesired input current or voltage (for example leakage current of test leads or test fixture).

- measurement units

You can use the zero offset cancel function for:

- low current measurement (measurement range ≤ 10 nA) by SMUs.
- differential mode V measurement by VMUs.
- offset data measurement range

Offset data is measured in the following measurement ranges only:

- for auto I range

HPSMU and MPSMU: 1 nA range

HRSMU: 10 pA range

- for fixed I range or limited auto I range

HPSMU and MPSMU: 1 nA range (only when 1 nA limited auto range is set in right RANGE column).

HRSMU: range set in right RANGE column (only when 1 nA, 100 pA, or 10 pA range is set).

If 10 nA is set in right RANGE column, offset data measurement is not performed, so offset cancel will use the present data.

- for differential V mode

0.2 V range (VMU2 measures voltage in grounded mode to confirm that voltage does not exceed ± 20 V.)

The offset data is measured in the range that is displayed in brackets in the ZERO CANCEL table.

Measurement Functions
Zero Offset Cancel

- offset cancel range

Offset cancel is performed (using the measured offset data) for the following measurement ranges:

- for auto range measurement

HPSMU and MPSMU:	1 nA and 10 nA range using offset data that was measured in 1 nA range.
HRSMU:	10 pA to 10 nA range using offset data that was measured in 10 pA range.
VMU:	0.2 V and 2 V range using offset data that was measured in 0.2 V range.

- limited auto and fixed range measurement

HPSMU and MPSMU:	1 nA and 10 nA range using offset data that was measured in 1 nA range.
HRSMU:	10 pA to 10 nA (when the offset data was measured in 10 pA range.) 100 pA to 10 nA (when the offset data was measured in 100 pA range.) 1 nA and 10 nA (when the offset data was measured in 1 nA range.)
VMU:	0.2 V and 2 V range using offset that was measured in 0.2 V range.

If measurement range setup is changed to a lower range than the range at which the offset data was measured, then offset cancel is not performed for the unit. (For example, if HRSMU measurement range is changed to auto range from 1 nA fixed range after measuring offset data in 1 nA range, OFF is displayed in the unit's ZERO CANCEL field. Because it is possible that auto range will use range lower than 1 nA.)

Measurement Functions
Zero Offset Cancel

Setup and Restrictions

To use zero offset cancel function, set ON in the ZERO CANCEL field on the MEASURE: MEASURE SETUP screen by selecting ZERO CANCEL ON/OFF secondary softkey.

You cannot set zero cancel function to ON and OFF for each individual unit. If you select OFF in the ZERO CANCEL field, zero offset cancel is not performed for any units. If you select ON in ZERO CANCEL field, ON is displayed for the units that can perform zero offset cancel.

Measuring Offset Data

To measure zero offset data, press green key, then press Stop front-panel key.

Even if OFF is set to the ZERO CANCEL field before offset data measurement, pressing green key and Stop front-panel key automatically sets ON in the ZERO CANCEL field, then performs the offset data measurement.

- integration time
During offset data measurement, integration time is set to specified time or medium, whichever is longer. After offset data measurement, integration time returns to same setting as before the offset measurement was performed.
- operation state
Offset data measurement and zero offset cancel can be performed from the *idle* or *standby* state.

Performing Offset Cancel

To perform offset cancel, press a measurement key. The measurement data is automatically compensated (by using the offset data) while measurement is performed.

NOTE**Offset Measurement Limit**

If measured offset data is too large for the offset measurement range as shown below, an error occurs. In such cases, an * is displayed in the field of the failed unit, and the 4155B/4156B keeps the previous offset data. The initial offset data is 0.

- HPSMU
greater than or equal to $\pm 1\%$ of 1 nA range.
- MPSMU
greater than or equal to $\pm 1\%$ of 1 nA range.

- HRSMU

offset meas. range: **measured offset data**

1 nA: greater than or equal to $\pm 1\%$ of 1 nA range.

100 pA: greater than or equal to $\pm 1\%$ of 100 pA range.

10 pA: greater than or equal to $\pm 4\%$ of 10 pA range.

- VMU
greater than or equal to $\pm 1\%$ of 0.2 V range. (If VMU2 grounded mode measurement value is greater than or equal to ± 20 V, error occurs.)

Measurement Functions
Zero Offset Cancel

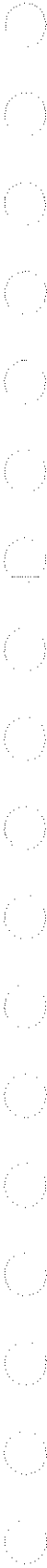

Making a Measurement

To make a measurement, mount your device under test (DUT), set up your 4155B/4156B for the measurement, then execute the measurement. The 4155B/4156B can execute sweep and sampling measurements. The 4155B/4156B can also force stress to your DUT.

This chapter describes the tasks for making measurements, and is organized into the following four sections:

- Connection to Device Under Test (DUT)
- Sweep Measurements
- Knob Sweep Measurements
- Sampling Measurements
- Stress Force

For details about how to enter or input setup data, refer to Chapter 6.

To satisfy the specifications of the 4155B/4156B and the 41501A/B measurement accuracy, perform calibration and adjustment every year and allow the 4155B/4156B and the 41501A/B to warm-up for a minimum of 40 minutes before you begin performing measurements.

Connection to Device Under Test (DUT)

This section describes how to connect your DUTs to the 4155B/4156B. Only the basic operations for connecting are described.

If the 4155B/4156B is not configured with a test fixture or your wafer prober yet, see Chapter 2 of *User's Guide General Information, Agilent 16442A Test Fixture User's Guide*, and your wafer prober manuals.

This section covers the 16442A test fixture only. For operating your wafer prober, see your wafer prober manuals.

Note that you must set the 4155B/4156B to the idle state when connecting or disconnecting your DUTs. If not, the DUTs may be damaged. To set to idle state, press Stop key and make sure Standby indicator is off.

The 4156B is designed for **Kelvin connections**. See “To Make Connections to Measure Low Resistance (For 4156B Only)” on page 4-8 for Kelvin connection theory.

This section has the following task descriptions:

- To mount a DUT on test fixture
- To make connections to reduce leakage current
- To make connections to measure low resistance (for the 4156B only)

Making a Measurement
Connection to Device Under Test (DUT)

To Mount a DUT on Test Fixture

1. Set your 4155B/4156B to idle state by pressing Stop key in the MEASUREMENT key group. If the standby indicator is lit, press the Standby key to turn off the standby indicator.
2. Select a proper socket module for your DUT, then set the module on the test fixture.
3. Mount your DUT on the socket module.
4. Connect the terminals of the socket module to the terminals of the test fixture by using the proper cables.
5. Close the lid of the test fixture, if necessary.

When the 4155B/4156B forces more than ± 40 V, close the lid of the test fixture. Otherwise, the interlock function will stop the 4155B/4156B output.

To connect the DUT on the test fixture, you can use cables that have the following connectors:

- Miniature banana — miniature banana
- Miniature banana — pin plug
- Miniature banana — miniature clip

CAUTION

Do not connect or disconnect your DUT and the 4155B/4156B while the 4155B/4156B is forcing voltage or current. Otherwise, your DUT may be damaged.

CAUTION

Do not touch the contact part of the connection cables. Oil, perspiration, and dirt prevent good electrical contact, deteriorate insulation, and degrade measurement accuracy.

Making a Measurement
Connection to Device Under Test (DUT)

Connections for High Current Measurement (4156B Only)

When you force or measure a large current, you may want to use a **Kelvin (4-wire) connection** to eliminate the residual resistance effects of test leads and contacts. For example, you can use the following connections as Kelvin connections on the test fixture:

Examples: Kelvin Connection

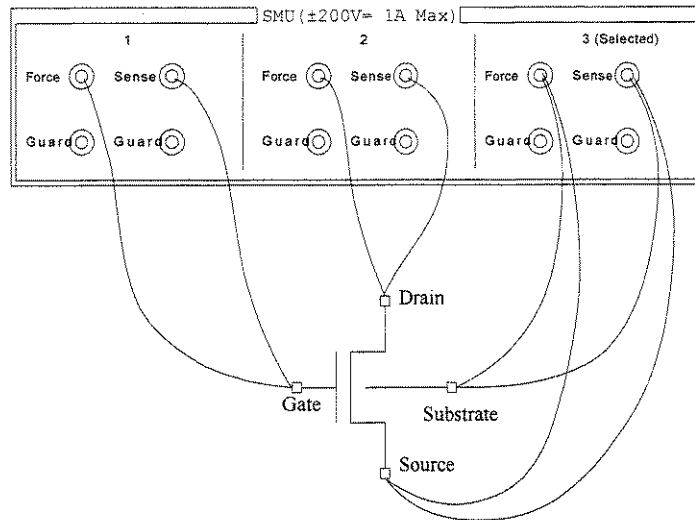

To cancel the effects of the residual resistance, test leads must be connected as close as possible to the DUT.

Making a Measurement
Connection to Device Under Test (DUT)

To Make Connections to Reduce Leakage Current

- Connect the terminals of the connector plate to the probing needles by using coaxial cables.
- Connect coaxial center conductor to force terminal (of connector plate) and tail of the probing needle.
- Connect coaxial outer conductor to guard terminal (of connector plate).

To reduce the leakage current, extend the guard conductor as close as possible to the DUT.

WARNING

Do not touch the guard terminal with bare hands because you may be shocked by high voltage. The potential of the guard terminal is equal to the output voltage.

CAUTION

Never connect the guard terminal to any other output, including circuit common, frame ground, or the guard terminal of any other unit. Doing so may damage the unit.

Example

The following example connection can be used to reduce the leakage current. Extend the outer conductor as close as possible to the probing needle. This also reduces the induced noise.

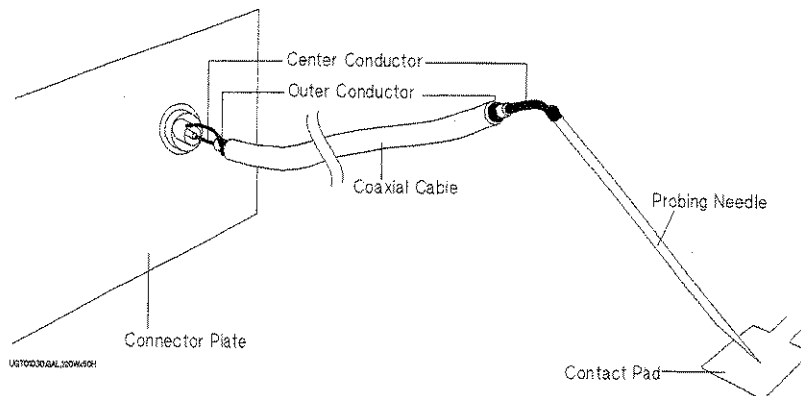

Making a Measurement Connection to Device Under Test (DUT)

Guarding

Guarding reduces the leakage current between the measurement points and instrument. This is important when you measure low current.

The following figure shows the theory of guarding. The buffer amplifier ($\times 1$) keeps the potential of the guard conductor at the same potential as the force conductor, so current does not flow between the force and guard conductors. Therefore, the current measured by SMU is same as current at measurement point because no current is leaked.

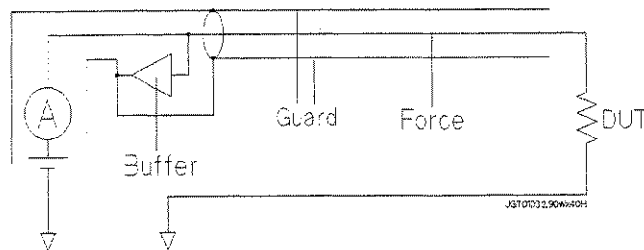

Making a Measurement

Connection to Device Under Test (DUT)

To Make Connections to Measure Low Resistance (For 4156B Only)

- Connect force and sense terminals of SMU as close as possible to the DUT.

When you measure a low resistance, high current flows through the DUT. This high current increases the measurement error caused by the residual resistance of cables and contacts. To cancel the effect of this resistance, you can use *Kelvin connections* (4-wire), which means the force and sense lines are extended separately to the DUT.

Example

The following example connection can be used to measure low resistance. The sense point of the voltage measurement is at the contact pad, so the voltage due to the residual resistance between the instrument and the sense point is canceled.

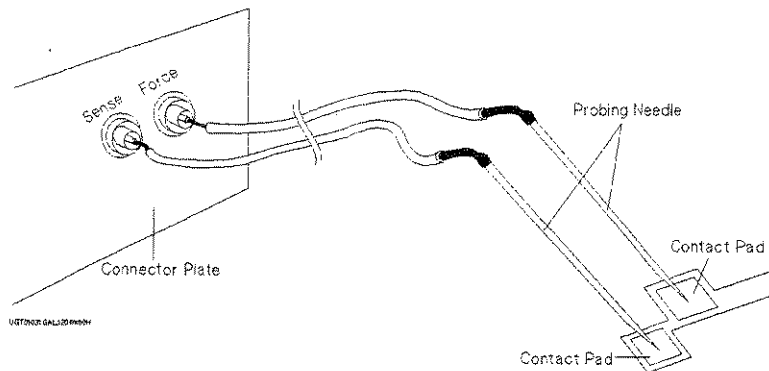

To reduce the leakage current, use coaxial cables to connect the connector plate to the probing needle.

Making a Measurement Connection to Device Under Test (DUT)

Kelvin Connection

Kelvin connections give good measurement results when you force high-current. The following figure shows the equivalent circuits for Kelvin and non-Kelvin connections.

- For the non-Kelvin connection, the voltmeter measures the voltage drop of resistances r_{F1} , R_{DUT} , and r_{F2} .
- For the Kelvin connection, the voltmeter measures the voltage drop of resistance R_{DUT} only. The impedance of the voltmeter is very high, so the voltage drop of resistances r_{S1} and r_{S2} is very small.

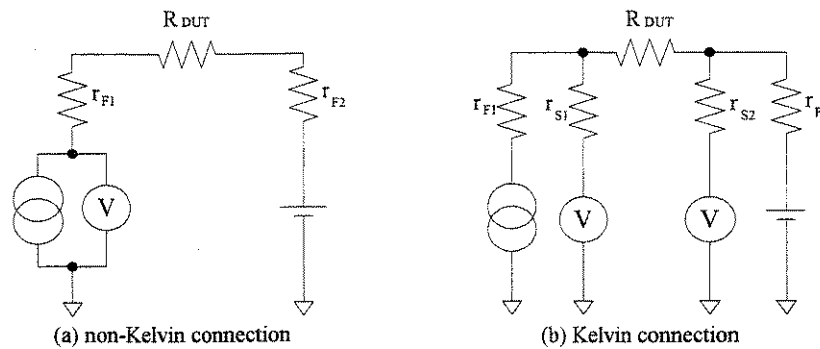

The Kelvin connection is effective even when forcing voltage. The voltage drop due to the residual resistance of the force line wiring is fed back to the voltage source via a comparator in the sense line, thereby ensuring the specified voltage output at the sense point (point where force and sense lines intersect). The input impedance of comparator is high, so current flow into the sense line is very low. Therefore, output error is not significant if the sense line wiring has a residual resistance of 10 Ω or less.

Making a Measurement
Sweep Measurements

Sweep Measurements

This section describes the sweep measurement tasks.

The basic procedure to test your DUT is as follows:

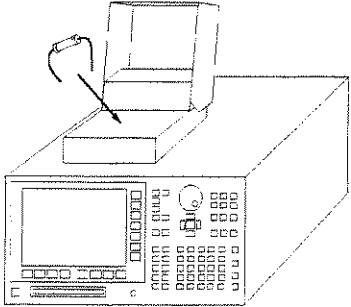
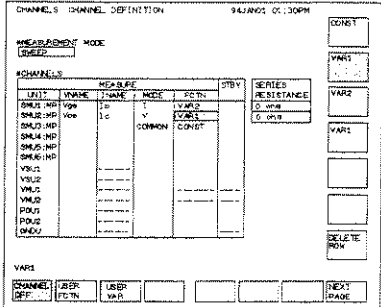
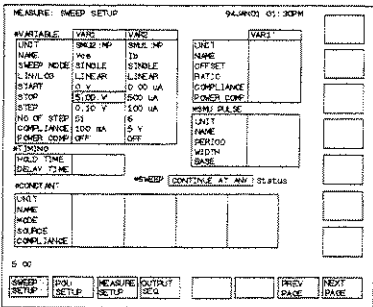
	<p>1. Connecting your DUT to the 4155B/4156B. See “Connection to Device Under Test (DUT)” on page 4-3 for procedures.</p>
	<p>2. Defining measurement mode and measurement units that you use to make measurement. The following tasks are described:</p> <ul style="list-style-type: none"> To Define Sweep Measurement Units To Define a User Function To Control R-Box
	<p>3. Setting the source parameters of the units. The following tasks are described:</p> <ul style="list-style-type: none"> To Set up Primary Sweep Source To Set up Secondary Sweep Source To Set up Synchronous Sweep Source To Set up Constant Output To Set up SMU Pulsed Output To Set up PGU Pulsed Output

Making a Measurement Sweep Measurements

	<p>4. Setting the display mode to show measurement results. The following tasks are described:</p> <ul style="list-style-type: none"> To Set up Graphical Display of Measurement Results To Set up List Display of Measurement Results
	<p>5. Executing the measurement. The following tasks are described:</p> <ul style="list-style-type: none"> To Output Same Value Before and After Measurements To Execute Calibration To Cancel Zero Offset To Execute or Stop Measurement
	<p>Results. For example, displayed graphically.</p>

Making a Measurement
Sweep Measurements

To Define Sweep Measurement Units

1. Press Chan key in the PAGE CONTROL key group.
2. Select CHANNEL DEF primary softkey.
3. In the MEASUREMENT MODE area, select SWEEP secondary softkey.
4. In the VNAME column, enter a unique name for voltage variable. For example, enter V_{ce} for collector-emitter voltage. If channel does neither V force nor V measurement, you can omit VNAME.
5. In the INAME column, enter a unique name for current variable. For example, enter "I_c" for collector current. If channel does neither I force nor I measurement, you can omit INAME.
6. In the MODE column, select:
 - V secondary softkey for voltage output mode (SMU, VSU, and PGU, and grounded voltage measurement mode of VMU).
 - I secondary softkey for current output mode (SMU).
 - VPULSE secondary softkey for pulsed voltage output mode (SMU and PGU).
 - IPULSE secondary softkey for pulsed current output mode (SMU).
 - COMMON secondary softkey for circuit common mode (SMU and GNDU).
 - DVOLT secondary softkey for differential voltage measurement mode (VMU).
7. In the FCTN column, select:
 - CONST secondary softkey for constant output function (SMU, VSU, and PGU).
 - VAR1 secondary softkey for primary sweep output function (SMU and VSU).
 - VAR2 secondary softkey for secondary sweep output function (SMU and VSU).
 - VAR1' secondary softkey for synchronous sweep output function (SMU and VSU).

For details about STBY and SERIES RESISTANCE fields, see "CHANNELS: CHANNEL DEFINITION screen" in Chapter 6 or "Operation States" in Chapter 3.

Making a Measurement
Sweep Measurements

VNAME and INAME

You can use VNAME and INAME names in user function definitions or for analysis on the GRAPHICS/LIST screens. These names must be 6 or less alphanumeric characters. First character must be alphabet character.

To disable a unit

Move the pointer to the row of the unit, then select the DELETE ROW secondary softkey. The settings in the row are deleted.

Example

The following settings show an example for measuring an n-p-n transistor's I-V characteristics. SMU1 is connected to base, SMU2 is connected to collector, and SMU3 is connected to emitter. SMU1 is set to current source (I mode) and secondary sweep (VAR2) function. SMU2 is set to voltage source (V mode) and primary sweep (VAR1) function. SMU3 is set to COMMON.

Example: Channel Definition: Sweep Measurement

CHANNELS: CHANNEL DEFINITION 94JAN01 01:30PM

*MEASUREMENT MODE
SWEEP

*CHANNELS

UNIT	VNAME	INAME	MODE	FCTN	STBY	SERIES RESISTANCE
SMU1:MP	Vbe	Ib	I	VAR2		0 ohm
SMU2:MP	Vce	Ic	V	VAR1		0 ohm
SMU3:MP			COMMON	CONST		
SMU4:MP						
SMU5:MP						
SMU6:MP						
VSU1	-----					
VSU2	-----					
VMU1	-----					
VHU2	-----					
PGU1	-----					
PGU2	-----					
GNDU	-----					

CONST
VAR1
VAR2
VAR1
DELETE ROW

VAR1

CHANNEL DEF USER FCTN USER VAR

NEXT PAGE

UG01002,100%70

Making a Measurement
Sweep Measurements

To Set up Primary Sweep Source

1. Define VAR1 unit as described in “To Define Sweep Measurement Units” on page 4-12.
 2. Press Meas key in the PAGE CONTROL key group.
 3. Select SWEEP SETUP primary softkey.
 4. In the SWEEP MODE field of the VAR1 column, select:
 - SINGLE secondary softkey to set single sweep mode.
 - DOUBLE secondary softkey to set double sweep mode.
 5. In the LIN/LOG field of the VAR1 column, select:
 - LINEAR secondary softkey to set linear step mode.
 - LOG XX secondary softkey to set logarithmic step mode. XX is 10, 25, or 50, which specifies the number of steps per decade.
 6. In the START field of the VAR1 column, enter the start value.
 7. In the STOP field of the VAR1 column, enter the stop value.

If you select LOG in LIN/LOG field, the polarity of stop value must be same as the polarity of start value.
 8. If you select LINEAR in LIN/LOG field, enter the step value in the STEP field of the VAR1 column. This field is not available for the logarithmic step mode.
- The NO OF STEP is automatically calculated from the start, stop, and step values.

To change the compliance value of VAR1

Enter desired compliance value into COMPLIANCE field of VAR1 column.

To modify the UNIT and NAME fields

Modify the UNIT and NAME fields on the CHANNELS: CHANNEL DEFINITION screen.

Making a Measurement Sweep Measurements

Example

The following example shows the primary sweep conditions (VAR1 parameters):

MEASURE: SWEEP SETUP 94JAN01 01:30PM

*VARIABLE	VAR1	VAR2
UNIT	SMU2:MP	
NAME	Vce	
SWEEP MODE	SINGLE	
LIN/LOG	LINEAR	
START	0 V	
STOP	5.00 V	
STEP	0.10 V	
NO OF STEP	51	
COMPLIANCE	100 mA	
POWER COMP	OFF	

*TIMING

HOLD TIME	0.0 s
DELAY TIME	0.000 s

*CONSTANT

UNIT				
NAME				
MODE				
SOURCE				
COMPLIANCE				

*SWEEP Status

5 00

UGC1003.90x70

Making a Measurement
Sweep Measurements

To Set up Secondary Sweep Source

1. Define VAR2 unit as described in “To Define Sweep Measurement Units” on page 4-12.
2. Press Meas key in the PAGE CONTROL key group.
3. Select SWEEP SETUP primary softkey.
4. In the START field of the VAR2 column, enter the start value.
5. In the STEP field of the VAR2 column, enter the step value.
6. In the NO OF STEP field of the VAR2 column, enter the number of steps.

To output secondary sweep source, you also need to set up primary sweep source. For details of how to set up primary sweep source, refer to “To Set up Primary Sweep Source” on page 4-14.

For secondary sweep source, the following is always set automatically: SWEEP MODE is set to SINGLE, and LIN/LOG is set to LINEAR. You cannot modify the SWEEP MODE and LIN/LOG fields for the secondary sweep source.

The STOP value is automatically calculated from the start value, step value, and the number of steps.

To change the compliance value of VAR2

Enter desired compliance value into COMPLIANCE field of VAR2 column.

To modify the UNIT and NAME fields

Modify the UNIT and NAME fields on the CHANNELS: CHANNEL DEFINITION screen.

Making a Measurement Sweep Measurements

Example

The following example shows the secondary sweep conditions (VAR2 parameters):

MEASURE: SWEEP SETUP 94JAN01 01:30PM

	VAR1	VAR2
UNIT	SMU2:MP	SMU1:MP
NAME	Vce	Ib
SWEEP MODE	SINGLE	SINGLE
LIN/LOG	LINEAR	LINEAR
START	0 V	0.00 uA
STOP	5.00 V	500 uA
STEP	0.10 V	100 uA
NO OF STEP	51	6
COMPLIANCE	100 mA	5 V
POWER_COMP	OFF	OFF

*TIMING

HOLD TIME 0.0 s
 DELAY TIME 0.000 s

*CONSTANT *SWEEP CONTINUE AT ANY Status

UNIT				
NAME				
MODE				
SOURCE				
COMPLIANCE				

0.0001

UG01004,90x70

Making a Measurement
Sweep Measurements

To Set up Synchronous Sweep Source

1. Define VAR1' unit as described in "To Define Sweep Measurement Units" on page 4-12.
2. Press Meas key in the PAGE CONTROL key group.
3. Select SWEEP SETUP primary softkey.
4. In the OFFSET field of the VAR1' column, enter the offset value.
5. In the RATIO field of the VAR1' column, enter the ratio value.

The output value of VAR1' is calculated by the following equation:

$$\text{VAR1}' = \text{VAR1} \times \text{RATIO} + \text{OFFSET}$$

To output synchronous sweep source, you also need to set up primary sweep source VAR1. For details of how to set up VAR1, refer to "To Set up Primary Sweep Source" on page 4-14. VAR1 and VAR1' must both be voltage output mode or both current output mode. For example, if VAR1 is V output mode, then VAR1' must be V or VPULSE output mode.

To change the compliance value of VAR1'

Enter desired compliance value into COMPLIANCE field of VAR1' column.

To modify the UNIT and NAME fields

Modify the UNIT and NAME fields on the CHANNELS: CHANNEL DEFINITION screen.

Making a Measurement Sweep Measurements

Example

The following example shows the synchronous sweep conditions (VAR1' parameters):

MEASURE: SWEEP SETUP 94JAN01 01:30PM

*VARIABLE	VAR1	VAR2	VAR1'
UNIT	SMU2:MP	SMU1:MP	SMU3:MP
NAME	Vce	Ib	Vsync
SWEEP MODE	SINGLE	SINGLE	0.00
LIN/LOG	LINEAR	LINEAR	100%
START	0 V	0.00 uA	100 uA
STOP	5.00 V	500 uA	OFF
STEP	0.10 V	100 uA	
NO OF STEP	51	6	
COMPLIANCE	100 mA	5 V	
POWER COMP	OFF	OFF	

*TIMING

HOLD TIME	0.0 s
DELAY TIME	0.000 s

*CONSTANT

UNIT				
NAME				
MODE				
SOURCE				
COMPLIANCE				

*SWEEP CONTINUE AT ANY Status

0.01

SWEEP SETUP
 PGU SETUP
 MEASURE SETUP
 OUTPUT SEQ

 PREVIOUS PAGE
 NEXT PAGE

UG01005,90x70

Making a Measurement
Sweep Measurements

To Set up Constant Output

1. Define CONST units as described in “To Define Sweep Measurement Units” on page 4-12.
2. Press Meas key in the PAGE CONTROL key group.
3. Select SWEEP SETUP primary softkey.
4. In the SOURCE field of the desired unit in the CONSTANT area, enter the desired output value.

To modify the UNIT, NAME, and MODE fields

Modify the UNIT, NAME, and MODE fields on the CHANNELS: CHANNEL DEFINITION screen.

Example

The following example shows the constant output conditions:

MEASURE: SWEEP SETUP 94JAN01 01:30PM

*VARIABLE	VAR1	VAR2
UNIT	SMU1:MP	
NAME	1f	
SWEEP MODE	SINGLE	
LIN/LOG	LOG 10	
START	1.00 uA	
STOP	1.00 mA	
STEP	-----	
NO OF STEP	31	
COMPLIANCE	1.00 mV	
POWER COMP	OFF	

*TIMING

HOLD TIME	0.0 s
DELAY TIME	0.000 s

*SWEEP CONTINUE AT ANY Status

*CONSTANT

UNIT	SMU2:MP			
NAME	Voff			
MODE	V			
SOURCE	1.0000 V			
COMPLIANCE	1.00 mA			

1.00

SWEEP SETUP	PGU SETUP	MEASURE SETUP	OUTPUT SEQ			PREV PAGE	NEXT PAGE
----------------	--------------	------------------	---------------	--	--	--------------	--------------

UG01006,90x70

To Set up SMU Pulsed Output

On the CHANNEL DEFINITION screen, you can set *only one* SMU to be a pulsed source. Then, you set the pulse parameters in the SMU PULSE area of the SWEEP SETUP screen.

1. Define SMU to be VPULSE or IPULSE mode as described in “To Define Sweep Measurement Units” on page 4-12.
 - For pulsed sweep source, specify SMU FCTN to be VAR1, VAR2, or VAR1'.
 - For pulsed constant source, specify SMU FCTN to be CONST.
2. Press Meas key in the PAGE CONTROL key group.
3. Select SWEEP SETUP primary softkey.
4. Set as follows:
 - For pulsed sweep source, set up VAR1, VAR2, or VAR1' area.
 - For pulsed constant source, set up CONSTANT area.
5. In the PERIOD field of the SMU PULSE area, enter the pulse period value.
6. In the WIDTH field of the SMU PULSE area, enter the pulse width value.
7. In the BASE field of the SMU PULSE area, enter the pulse base value.

Example

The following shows an example setup of SMU pulsed output on the MEASURE: SWEEP SETUP screen.

MEASURE: SWEEP SETUP 94JAN01 01:30PM

*VARIABLE	VAR1	VAR2
UNIT	SMU1:MP	
NAME	If	
SWEEP MODE	SINGLE	
LIN/LOG	LOG 10	
START	1.00 uA	
STOP	1.00 mA	
STEP	-----	
NO OF STEP	91	
COMPLIANCE	100 mV	
POWER COMP	-----	

*SMU PULSE	
UNIT	SMU1:MP
NAME	If
PERIOD	10.0ms
WIDTH	1.00ms
BASE	0.000 A

*TIMING
HOLD TIME: 0.0 s

*CONSTANT

UNIT	SMU2:MP			
NAME	Voff			
MODE	V			
SOURCE	5.000 V			
COMPLIANCE	100 mA			

*SWEEP [CONTINUE AT ANY] Status

0.001

SWEEP SETUP MEASURE OUTPUT PREV NEXT
SETUP SETUP SEQ PAGE PAGE

UG01039:90x70

Making a Measurement Sweep Measurements

To modify the UNIT and NAME fields

Modify the UNIT and NAME fields on the CHANNELS: CHANNEL DEFINITION screen.

Relation between the PERIOD, WIDTH, and BASE

The relation between the PERIOD, WIDTH, and BASE values are as shown in the following figures.

For figure (a), the SMU is set on the CHANNELS: CHANNEL DEFINITION screen as follows:

- MODE: VPULSE or IPULSE
- FCTN: VAR1, VAR2, or VAR1'

For figure (b), the SMU is set on the CHANNELS: CHANNEL DEFINITION screen as follows:

- MODE: VPULSE or IPULSE
- FCTN: CONST

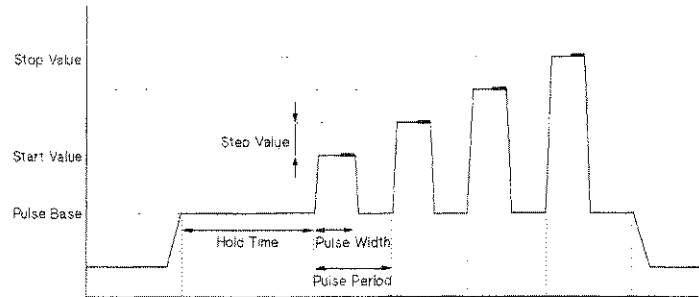

(a) For Pulsed Sweep Source

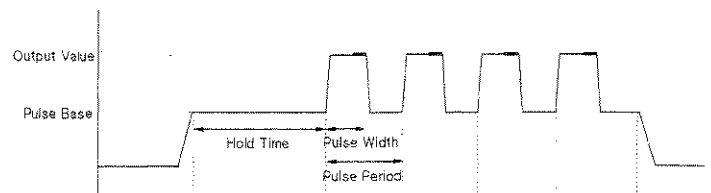

(b) For Pulsed Constant Source

The pulse peak values depend on the values you set in the VAR1, VAR1', VAR2, or CONSTANT area.

To Set up PGU Pulsed Output

1. Define PGU to be VPULSE and CONST as described in “To Define Sweep Measurement Units” on page 4-12.
2. Press Meas key in the PAGE CONTROL key group.
3. Select PGU SETUP primary softkey.
4. In the PERIOD field of PGU1, enter the pulse period value.
5. In the WIDTH field of desired PGU column, enter the pulse width value.
6. In the DELAY TIME field of desired PGU column, enter delay time value.
7. In the PEAK VALUE field of desired PGU column, enter pulse peak value.
8. In the BASE VALUE field of desired PGU column, enter pulse base value.
9. In the LEADING TIME field of desired PGU column, enter the leading-edge transition time.
10. In the TRAILING TIME field of desired PGU column, enter the trailing-edge transition time.
11. In the IMPEDANCE field of desired PGU column, select:
 - LOW secondary softkey for approximately zero ohm output impedance.
 - 50 ohm secondary softkey for 50 ohm output impedance.
12. In the PULSE COUNT field, do one of the following:
 - Select FREE RUN secondary softkey to force the pulse continuously.
 - Or enter the number of pulses to output (for sampling measurement only).

For the pulse period and pulse count values, the values you set for PGU1 are also used for PGU2. The following figure shows the relation between pulse waveform and setup parameters.

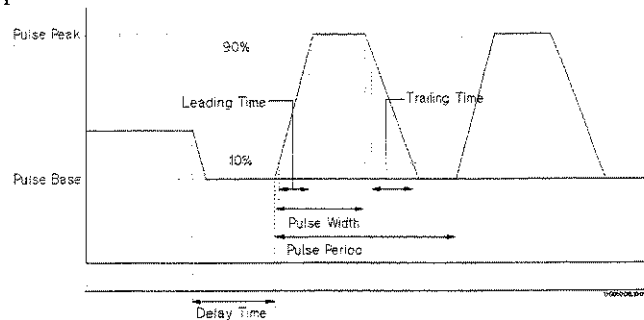

Making a Measurement
Sweep Measurements

To modify the UNIT and NAME fields

Modify the UNIT and NAME fields on the CHANNELS: CHANNEL DEFINITION screen.

Using PGUs as constant voltage source

To use a PGU as a constant voltage source, set the desired PGU as follows:

- V in MODE column on the CHANNEL DEFINITION screen
- Desired output voltage value in SOURCE field on MEASURE: PGU SETUP screen.

Example

The following example shows setup of PGU pulsed output on the MEASURE: PGU SETUP screen.

You cannot set compliance for a PGU, which has a 100 mA current limit.

MEASURE: PGU SETUP 94JAN01 01:30PM

*PULSE		PGU1	PGU2
UNIT			
NAME			
PERIOD		10.00ms	
WIDTH		5.00ms	
DELAY TIME		0.00000 s	
PEAK VALUE		100mV	
BASE VALUE		0.00 V	
LEADING TIME		100ns	
TRAILING TIME		100ns	
IMPEDANCE		LOW	
PULSE COUNT		0	

*CONSTANT		PGU1	PGU2
UNIT			
NAME			
SOURCE			

0.00500

UG01040,100x70

To Output Same Value Before and After Measurements

1. Press Chan key in the PAGE CONTROL key group.
2. Select CHANNEL DEF primary softkey.
3. In the STBY column of the desired unit, select STANDBY ON secondary softkey.
4. Press Standby key in the MEASUREMENT key group.

The indicator above the Standby key shows whether the Standby function is enabled. If this indicator is ON, then for the units that you selected STANDBY ON, the units have the following output value during the Standby state (that is, before and after measurements or stress):

Function of a Unit	Output during Standby State
VAR1	VAR1 Start value
VAR1'	$\text{Ratio} \times \text{Start} + \text{Offset}$
VAR2	VAR2 Start value
CONSTANT	Output value

For sampling measurements, only the CONSTANT function is available.

From Standby state, you can execute measurements or force stress by pressing Single, Repeat, Append, or Stress key. After measurement or stress, the STANDBY ON units are returned to same output value as before measurement or stress.

If Standby indicator is ON, then pressing the Standby key disables the Standby function, and Standby output stops. Pressing the Stop key has no affect on the Standby state.

To Set up Graphical Display of Measurement Results

1. Press Display key in the PAGE CONTROL key group.
2. Select DISPLAY SETUP primary softkey.
3. In the DISPLAY MODE field, select GRAPHICS secondary softkey.
4. In the X axis column, enter variable name, select axis scale, and enter minimum and maximum values.
5. In the Y1 axis column, enter variable name, select axis scale, and enter minimum and maximum values.
6. If you use Y2 axis, enter variable name, select axis scale, and enter minimum and maximum values in Y2 axis column.

When the pointer is in the NAME row, the allowable variable names appear in the secondary softkey area. To set a variable name, select the desired secondary softkey. The allowable names are names that you already set up on the CHANNEL DEFINITION, USER FUNCTION, and USER VARIABLE screens.

To display a grid on the plotting area

In GRID field, select ON secondary softkey.

To remove the grid

In GRID field, select OFF secondary softkey.

To control display of line parameters on GRAPHICS screen

In LINE PARAMETER field, select ON to display or OFF to not display. Line parameters are the X and Y intercepts and gradient of the analysis lines.

To set up variable to be displayed on the GRAPHICS screen

In DATA VARIABLES fields, select secondary softkey for desired variable.

To Set up List Display of Measurement Results

1. Press Display key in the PAGE CONTROL key group.
2. Select DISPLAY SETUP primary softkey.
3. In the DISPLAY MODE field, select LIST secondary softkey.
4. In the LIST area, select the secondary softkey of the variables for which you want to list the measurement results.

When the pointer is in the NAME row, the allowable variable names appear in the secondary softkey area. To set a variable name, select the desired secondary softkey. The allowable names are names that you already set up on CHANNEL DEFINITION, USER FUNCTION, and USER VARIABLE screens.

To set up variable to be displayed on the LIST page

In DATA VARIABLES fields, select secondary softkey for desired variable.

Example

Following figure is an example setup to display VE, IC, and IB on LIST screen.

DISPLAY: DISPLAY SETUP 94JAN01 01:30PM

*DISPLAY MODE
LIST

*LIST

NO.	NAME
1	VE
2	IC
3	IB
4	
5	
6	
7	
8	

*DATA VARIABLES

IB

DISPLAY
SETUP

AUTO
ANALYSIS

PREV
PAGE

NEXT
PAGE

VE

VC

VB

IE

IC

IB

MORE
1/2

UG01038,100*70

Making a Measurement
Sweep Measurements

To Execute Calibration

To execute all self-calibration test items, perform the following:

1. Press System key in the PAGE CONTROL key group.
2. Select CALIB/DIAG primary softkey.
3. In the SYSTEM: SELF-CALIBRATION/DIAGNOSTICS screen, select CALIB ALL secondary softkey. After the calibration execution, each test result is displayed in each STATUS field.

To set auto-calibration

Move the pointer to the AUTO CALIB field, then select the ON secondary softkey. Self-calibration is performed automatically every 30 minutes.

Be aware that measurement cannot be performed while calibration is executed.

To Cancel Zero Offset

1. Press Meas key in the PAGE CONTROL key group.
2. Select MEASURE SETUP primary softkey.
3. In the ZERO CANCEL field, select ZERO CANCEL ON/OFF secondary softkey to toggle the zero offset cancel mode between on and off. Then ON or OFF appear automatically in each unit field depending on the measurement range.
4. Press green key, then Stop key to measure the zero offset data. Then this measured data is used to compensate the measurement results when measurement is performed.

For more details about the zero offset cancel function, refer to “Zero Offset Cancel” in Chapter 3.

To Execute or Stop Measurement

- To execute a measurement, press:
 - Single key in the MEASUREMENT key group for single measurement.
 - Repeat key in the MEASUREMENT key group for repeat measurement.
 - Append key in the MEASUREMENT key group for append measurement.
- To stop a measurement, press Stop key in the MEASUREMENT key group.

Single, Repeat, and Append Measurement

There are three measurement execution modes as follows:

Single measurement	Clears GRAPHICS or LIST screen, then executes measurement one time. Measurement results are displayed on GRAPHICS or LIST screen.
Repeat measurement	Executes measurements continuously. Before each measurement is executed, the GRAPHICS or LIST screen is cleared. Most recent measurement results are displayed on GRAPHICS or LIST screen.
Append measurement	Executes measurement one time. Does <i>not</i> clear GRAPHICS or LIST screen. That is, measurement results are added to the existing results.

Making a Measurement
Sweep Measurements

To Control R-Box

1. Connect the 16441A R-Box to the 4155B/4156B and to the 16442A Test Fixture or connector plate on your shield box. For details about connections, refer to “R-BOX Control” in Chapter 3.
2. Press Chan front-panel key of the PAGE CONTROL key group.
3. Select CHANNEL DEF primary softkey to display the CHANNELS: CHANNEL DEFINITION screen.
4. In the SERIES RESISTANCE fields, select:
 - 0 ohm secondary softkey to connect 0 Ω resistance.
 - 10k ohm secondary softkey to connect 10 k Ω resistance.
 - 100k ohm secondary softkey to connect 100 k Ω resistance.
 - 1M ohm secondary softkey to connect 1 M Ω resistance.

Resistance is switched just before and just after measurement state. In the standby state, the stress force state, and the idle state, 0 Ω is connected.

The 4155B/4156B automatically compensates for the resistance values.

For the following SMUs, you can set 0 Ω *only*:

- SMU that is set to ON in the STBY field.
- SMU that is set to COMMON in the MODE field.

You can set resistance values for the following SMUs.

- If the 41501A/B SMU/Pulse Generator Expander is not installed or does not have an HPSMU
 - SMU1
 - SMU2
- If the 41501A/B has an HPSMU
 - SMU1
 - SMU5

Making a Measurement Sweep Measurements

To measure negative resistance characteristics

The 16441A R-Box allows SMUs to measure current-controlled negative resistance ($1\text{ M}\Omega$) characteristics.

Connect the resistance of the 16441A as shown in following figure.

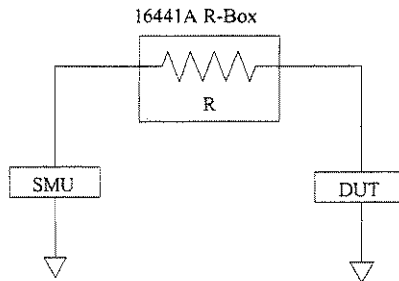

Example

The following figure shows an example setup to connect $10\text{ k}\Omega$ resistance to SMU1 and SMU2.

CHANNELS: CHANNEL DEFINITION 94JAN01 01:30PM

*MEASUREMENT MODE
SWEEP

*CHANNELS

UNIT	VNAME	INAME	MODE	FCTN	STBY	SERIES RESISTANCE
SMU1:MP	Vbe	Ib	I	VAR2		10k ohm
SMU2:MP	Vce	Ic	V	VAR1		10k ohm
SMU3:MP			COMMON	CONST		
SMU4:MP						
SMU5:MP						
SMU6:MP						
VSU1	-----					
VSU2	-----					
VMU1	-----					
VMU2	-----					
PGU1	-----					
PGU2	-----					
GNDU	-----					

10k ohm

CHANNEL DEF USER FCTN USER VAR

NEXT PAGE

VG01026,10/97

Making a Measurement
Knob Sweep Measurements

Knob Sweep Measurements

This section covers the following tasks about knob sweep measurements.

- To execute knob sweep measurement
- To stop knob sweep measurement

The knob sweep function is useful in the following cases:

- when you want to determine a parameter value for normal sweep
- when you want to quickly make a rough measurement of a DUT characteristics

The following figure shows the KNOB SWEEP screen.

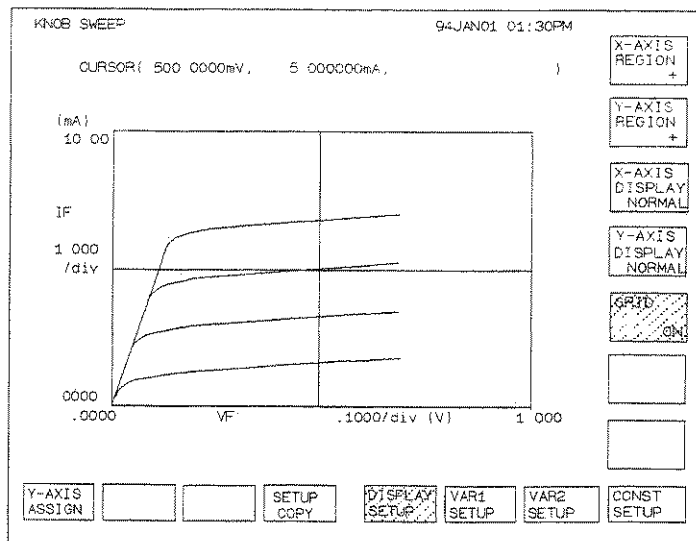

To Execute Knob Sweep Measurement

1. Define the measurement units on the CHANNELS: CHANNEL DEFINITION screen as described in “To Define Sweep Measurement Units” on page 4-12.
2. Set the sweep information on the MEASURE: SWEEP SETUP screen.
For details, refer to the following:
 - “To Set up Primary Sweep Source” on page 4-14
 - “To Set up Secondary Sweep Source” on page 4-16
 - “To Set up Constant Output” on page 4-20
3. Set the MEASURE: PGU SETUP screen (if you use PGUs).
4. Press the green key. Then, press Single front-panel key to display the KNOB SWEEP screen.
5. Select DISPLAY SETUP primary softkey to display DISPLAY SETUP secondary key group.
6. Select X-AXIS REGION secondary softkeys to set the desired X axis display region. Selecting the X-AXIS REGION secondary softkey toggles as follows:
+ → - → +/- → +
7. Select Y-AXIS REGION secondary softkeys to set the desired Y axis display region. Selecting the Y-AXIS REGION secondary softkey toggles as follows:
+ → - → +/- → +
8. Rotate the rotary knob to stretch or shrink the measurement curve.

If you set constant outputs or PGU output in step 2 or 3, the outputs start immediately after you perform step 4.

During measurements, self-test, or forcing stress, step 4 is ignored.

Making a Measurement Knob Sweep Measurements

Note the following restrictions:

- CHANNELS: CHANNEL DEFINITION screen
 - MEASUREMENT MODE field
In the MEASUREMENT MODE field, be sure to set SWEEP. If you select SAMPLING MODE, you cannot execute knob sweep measurement.
 - MODE field
Pulsed SMU (VPULSE and IPULSE) are not available for knob sweep measurement.
 - FCTN field
VARI' is not available for knob sweep measurement.
- MEASURE: SWEEP SETUP screen
You cannot use the power compliance function for knob sweep measurement.

If you ignore restrictions for knob sweep setup

If CHANNELS or MEASURE screen group have settings that are not available for knob sweep measurements, a warning message is displayed, then the STOP and CONT primary softkeys are displayed.

If you select STOP softkey, the incorrect setting is highlighted, and you can correct it.

If you select CONT softkey, the 4155B/4156B performs knob sweep measurement as follows:

- If VARI' is set in the FCTN field on the CHANNELS: CHANNEL DEFINITION screen:
The channel that is set to VARI' set to CONST (output value: VARI' start). So synchronous measurement is not performed.
- If an SMU is set to VPULSE or IPULSE the MODE field on the CHANNELS: CHANNEL DEFINITION screen:
Non-pulsed sweep measurement is performed.
- If the POWER COMP fields are set on the MEASURE: SWEEP SETUP screen:
The specified values are ignored. Measurement is performed the same as if OFF is selected.

Making a Measurement Knob Sweep Measurements

To change the variable assigned to y axis

Do as follows:

1. Press Stop front-panel key.
2. Select Y-AXIS ASSIGN primary softkey.
3. Select a secondary softkey to assign the desired variable name to y axis.

The available variables are the variables you entered in the INAME and VNAME columns of the CHANNELS: CHANNEL DEFINITION screen. You cannot use user functions or user variables.

To copy setups on the knob sweep page

Select SETUP COPY primary softkey to copy setups on this screen to the MEASURE: SWEEP SETUP and DISPLAY: DISPLAY SETUP screens.

Example

The following figure shows an example to set both X axis and Y axis display regions to positive.

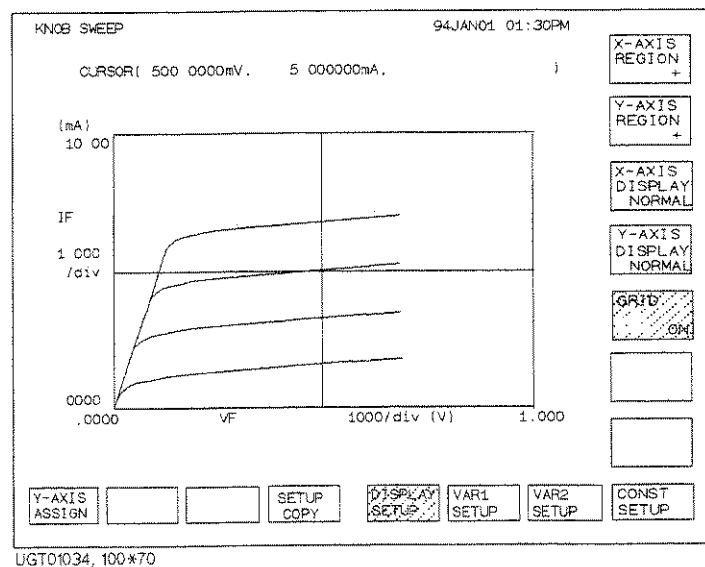

Making a Measurement
Knob Sweep Measurements

To Stop Knob Sweep Measurement

- Press Stop front-panel key.

If you execute knob sweep measurement from the idle state, pressing Stop front-panel key returns to the idle state.

If you execute knob sweep measurement from the standby state, pressing Stop front-panel key returns to the standby state.

Starting knob sweep again after pressing Stop front-panel key

If you stop knob sweep measurement, then start the measurement again, the measurement start point depends on how you start the measurement.

- started by Single front-panel key *only*

If you press the Single front-panel key, the knob sweep measurement starts from the point where it was stopped by Stop front-panel key.

- started by green key and Single front-panel key

If you press the green key, then press Single front-panel key, the knob sweep measurement starts from 0 V or 0 A.

Sampling Measurements

This section covers the tasks for sampling measurements.

The basic procedure to test your DUT is as follows:

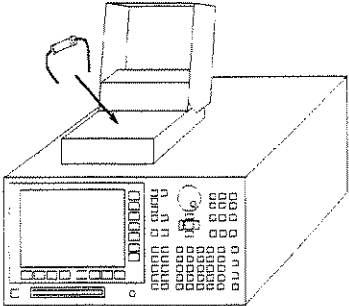
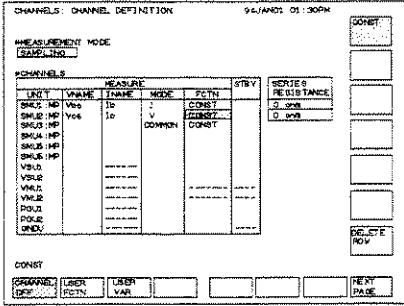
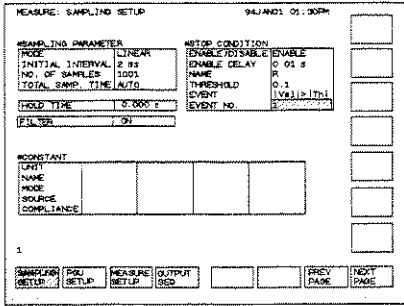
	<p>1. Connecting your DUT to the 4155B/4156B. See “Connection to Device Under Test (DUT)” on page 4-3 for procedures.</p>
	<p>2. Defining measurement mode and measurement units that you use to make measurement. The following tasks are described:</p> <ul style="list-style-type: none"> • To Define Sampling Measurement Units. • To Define a User Function (see previous section) • To Control R-Box (see previous section)
	<p>3. Setting the source parameters of the units. The following tasks are described:</p> <ul style="list-style-type: none"> • To Set up Sampling Parameters • To Set up Constant Output • To Define Measurement Stop Conditions • To Set up PGU Pulsed Output (see previous section)

Making a Measurement Sampling Measurements

	<p>4. Setting the display mode to show measurement results. The following tasks are described:</p> <ul style="list-style-type: none"> To Set up Graphical Display of Measurement Results (see previous section) To Set up List Display of Measurement Results (see previous section)
	<p>5. Executing the measurement. The following tasks are described:</p> <ul style="list-style-type: none"> To Output Same Value Before and After Measurements (see previous section) To Execute Calibration (see previous section) To Cancel Zero Offset (see previous section) To Execute or Stop Measurement (see previous section)
	<p>Results. For example, displayed graphically.</p>

To Define Sampling Measurement Units

1. Press Chan key in the PAGE CONTROL key group.
2. Select CHANNEL DEF primary softkey.
3. In the MEASUREMENT MODE area, select SAMPLING secondary softkey.
4. In the VNAME column, enter a unique name for voltage variable. For example, enter V_{ce} for collector-emitter voltage. If channel does neither V force nor V measurement, you can omit VNAME.
5. In the INAME column, enter a unique name for current variable. For example, enter "Ic" for collector current. If channel does neither I force nor I measurement, you can omit INAME.
6. In the MODE column, select:
 - V secondary softkey for voltage output mode (SMU, VSU, and PGU, and grounded voltage measurement mode of VMU).
 - I secondary softkey for current output mode (SMU).
 - VPULSE secondary softkey for pulsed voltage output mode (PGU).
 - COMMON secondary softkey for circuit common mode (SMU and GNDU).
 - DVOLT secondary softkey for differential voltage measurement mode (VMU).
7. In the FCTN column, select CONST secondary softkey for all source units.

For details about STBY and SERIES RESISTANCE fields, see "CHANNELS: CHANNEL DEFINITION screen" in Chapter 6 or "Operation States" in Chapter 3.

VNAME and INAME

You can use VNAME and INAME in user function definitions or for analysis on the GRAPHICS/LIST screens. These names must be 6 or less alphanumeric characters. First character must be alphabet character.

To disable a unit

Move the pointer to the row of the unit, then select the DELETE ROW secondary softkey. The settings in the row are deleted.

To Set up Sampling Parameters

1. Confirm that **SAMPLING** is set in the **MEASUREMENT MODE** field on the **CHANNELS: CHANNEL DEFINITION** screen. If **SAMPLING** is not set, select **SAMPLING** secondary softkey in the **MEASUREMENT MODE** field.
2. Press **Meas** key in the **PAGE CONTROL** key group.
3. Select **SAMPLING SETUP** primary softkey.
4. In the **MODE** field of **SAMPLING PARAMETER**, select:
 - **LINEAR** secondary softkey for equally spaced sampling intervals.
 - **LOG XX** secondary softkey for logarithmically spaced sampling intervals. **XX** is 10, 25, or 50 sampling points per decade.
 - **THINNED-OUT** secondary softkey for reduced sampling interval of more recent samples (by thinning less recent samples).

For details about sampling mode, see “Sampling Measurement Mode” in Chapter 2.

5. In the **INITIAL INTERVAL** field, enter a value for the first sampling interval.
6. In the **NO. OF SAMPLES** field, enter the number of points at which to sample.
7. If you select **LINEAR** or **THINNED-OUT** in **MODE** field, set the **TOTAL SAMP. TIME** (total sampling time) which specifies the time from the start of sampling to the end. This field is not available for the logarithmic sampling.

In the **TOTAL SAMP. TIME** field, enter a value or select:

- **NO LIMIT** secondary softkey for excluding the total sampling time from the sampling completion conditions.
- **AUTO** secondary softkey for excluding the total sampling time from the sampling completion conditions, and including the number of samples to the completion conditions. This softkey is available only for the linear sampling.

For details about sampling completion conditions, see “Sampling Measurement Mode” in Chapter 2.

Making a Measurement Sampling Measurements

The following figure shows the relation between the sampling parameters and sampling measurement.

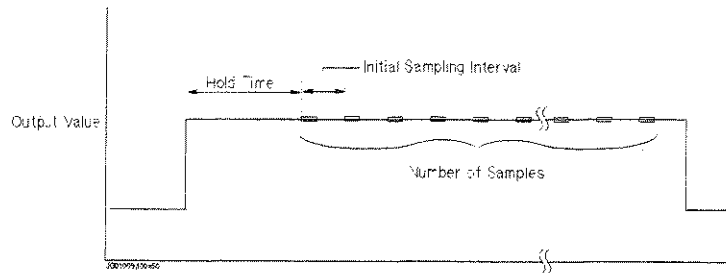

You can set a hold time by entering a number (units: seconds) in the HOLD TIME field.

Example

The following figure shows example setup of the sampling parameters.

MEASURE: SAMPLING SETUP 94JAN01 01:30PM

*SAMPLING PARAMETER		*STOP CONDITION	
MODE	LINEAR	ENABLE/DISABLE	ENABLE
INITIAL INTERVAL	2 ms	ENABLE DELAY	0.01 s
NO. OF SAMPLES	1001	NAME	R
TOTAL SAMP. TIME	AUTO	THRESHOLD	0.1
HOLD TIME	<input type="text"/>	EVENT	Val > Th
FILTER	<input type="text"/>	EVENT NO.	4

*CONSTANT				
UNIT	<input type="text"/>	<input type="text"/>	<input type="text"/>	<input type="text"/>
NAME	<input type="text"/>	<input type="text"/>	<input type="text"/>	<input type="text"/>
MODE	<input type="text"/>	<input type="text"/>	<input type="text"/>	<input type="text"/>
SOURCE	<input type="text"/>	<input type="text"/>	<input type="text"/>	<input type="text"/>
COMPLIANCE	<input type="text"/>	<input type="text"/>	<input type="text"/>	<input type="text"/>

1

UGT01043,100x70

To Set up Constant Output

1. Define CONST units as described in “To Define Sampling Measurement Units” on page 4-41.
2. Press Meas key in the PAGE CONTROL key group.
3. Select SAMPLNG SETUP primary softkey.
4. In the SOURCE field of the desired unit in the CONSTANT area, enter the desired output value.

To modify the UNIT, NAME, and MODE field

Modify the UNIT, NAME, and MODE fields on the CHANNELS: CHANNEL DEFINITION screen.

To set up compliance value for constant output

Set desired value in the COMPLIANCE field of the CONSTANT table. For details about compliance, see “Compliance” in Chapter 3.

Example

The following example shows the constant output conditions:

MEASURE: SAMPLING SETUP		94JAN01 01:30PM		
*SAMPLING PARAMETER		*STOP CONDITION		
MODE	LINEAR	ENABLE/DISABLE	ENABLE	
INITIAL INTERVAL	2 ms	ENABLE DELAY	0 01 s	
NO OF SAMPLES	1001	NAME	R	
TOTAL SAMP. TIME	AUTO	THRESHOLD	0 1	
		EVENT	val > Th	
		EVENT NO.	1	
HOLD TIME				
FILTER				
*CONSTANT				
UNIT	SMU2:HR			
NAME	V2			
MODE	V			
SOURCE	1.000V			
COMPLIANCE	100.00mA			
1 00				
SAMPLING SETUP	PGU SETUP	MEASURE SETUP	OUTPUT SEQ	PREV PAGE
				NEXT PAGE

UGT01047,100x70

Making a Measurement
Sampling Measurements

To Define Measurement Stop Conditions

The measurement stop condition defines the condition to stop the sampling measurement. The stop condition is one of the sampling completion conditions. For the sampling completion conditions, see “Sampling Measurement Mode” in Chapter 2.

1. Press Meas key in the PAGE CONTROL key group.
2. Select SAMPLNG SETUP primary softkey.
3. In the ENABLE/DISABLE field of the STOP CONDITION area, select ENABLE secondary softkey.
4. In NAME field of STOP CONDITION area, select the secondary softkey for the desired variable name or user function name to be used for EVENT comparison.
5. In THRESHOLD field of STOP CONDITION area, enter the threshold value for the name selected in the previous step.
6. In EVENT field of STOP CONDITION area, select:
 - Val > Th secondary softkey to stop the sampling when the sampled value is greater than the threshold value.
 - Val < Th secondary softkey to stop the sampling when the sampled value is less than the threshold value.
 - |Val| > |Th| secondary softkey to stop the sampling when the absolute sampled value is greater than the absolute threshold value.
 - |Val| < |Th| secondary softkey to stop the sampling when the absolute sampled value is less than the absolute threshold value.
7. In EVENT NO. field, enter a value which specifies the sampling to stop when EVENT occurs EVENT NO. times.

If you select DISABLE in the ENABLE/DISABLE field, the sampling measurement continues until:

- Stop key in the MEASUREMENT key group is pressed.
- Specified total sample time has elapsed.
- The 4155B/4156B receives GPIB command to stop sampling.
- An emergency condition occurs on the 4155B/4156B.
- Interlock terminal opens due to high voltage. (See Chapter 2 of *User's Guide General Information*.)

Making a Measurement Sampling Measurements

Example

The following figure shows an example setup of stop condition.

MEASURE: SAMPLING SETUP 94JAN01 01:30PM

*SAMPLING PARAMETER		*STOP CONDITION	
MODE	LINEAR	ENABLE/DISABLE	ENABLE
INITIAL INTERVAL	2 ns	ENABLE DELAY	0.005
NO OF SAMPLES	1000	NAME	R
TOTAL SAMP. TIME	AUTO	THRESHOLD	0.1
HOLD TIME 0.000 s		EVENT	Val > Th
FILTER ON		EVENT NO.	1

*CONSTANT				
UNIT				
NAME				
MODE				
SOURCE				
COMPLIANCE				

1

0676910100010

Stress Force

This section covers the tasks for stress forcing.

Two types of stress can be forced by the 4155B/4156B:

- *dc stress*
 - Dc voltage stress can be forced from SMUs, VSUs, or PGUs.
 - Dc current stress can be forced from SMUs.
- *ac stress* (also called *pulsed stress*)
 - Ac voltage stress can be forced from PGUs.
 - Ac current stress *cannot* be forced from the 4155B/4156B.

Making a Measurement Stress Force

The following illustrates the basic procedures for stress forcing.

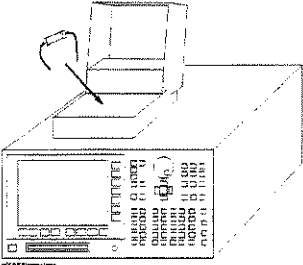
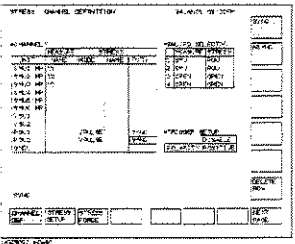
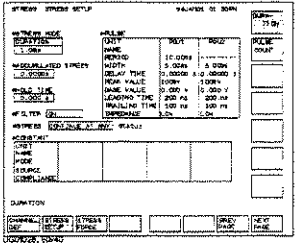
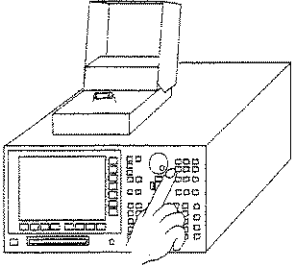
	<p>1. Connecting your DUT to the 4155B/4156B. See “Connection to Device Under Test (DUT)” on page 4-3 for procedures.</p>
	<p>2. Defining the stress units and constant output units. The following tasks are described:</p> <ul style="list-style-type: none"> • “To Set up Stress Source Channels” on page 4-50 • “To Control Selector for Switching SMU and PGU” on page 4-59
	<p>3. Setting the stress forcing parameters and constant output value. The following tasks are described:</p> <ul style="list-style-type: none"> • “To Set up Stress Condition/Timing” on page 4-52 • “To Set up AC (Pulse) Stress” on page 4-54 • “To Set up DC Stress” on page 4-56
	<p>4. Executing the stress forcing. The following task is described in “To Force Stress” on page 4-57.</p>

Making a Measurement
Stress Force

To Set up Stress Source Channels

1. Press Stress key in the PAGE CONTROL key group.
2. Select CHANNEL DEF primary softkey.
3. In the MODE field of desired unit in CHANNELS area, select:
 - V secondary softkey for dc voltage stress forcing mode (SMU, VSU, and PGU).
 - I secondary softkey for dc current stress forcing mode (SMU).
 - VPULSE secondary softkey for ac voltage stress forcing mode (PGU).
 - COMMON secondary softkey for circuit common (SMU and GNDU).
4. In the NAME field of desired unit in the CHANNELS area, enter the stress channel name.
5. In the FCTN field of units that will be stress force channels, select SYNC secondary softkey.

The stress channel name is only used for reference on the STRESS SETUP screen, not on any results screen. So, you can omit the name if desired.

In the FCTN column, you can set up to four units to SYNC. At least one unit must be set to SYNC in the FCTN column. The SYNC (stress force) units all start forcing stress at the same time. The NSYNC (non-stress force units) channels start forcing stress in sequence when state changes to stress force state. For this timing, see "Stress Force Sequence" in Chapter 3.

If the row of a unit does not have settings, the unit is not used.

To disable a unit

In the row of the unit, select the DELETE ROW secondary softkey. The settings in the row are deleted.

To set up non-stress output channels

Perform the following procedure.

1. Perform first 3 steps described above.
2. In the FCTN field, select NSYNC secondary softkey.

If you use two PGUs as pulsed sources (VPULSE), both must be SYNC or both NSYNC.

Making a Measurement Stress Force

Example

The following figure shows an example setup to set two PGUs to ac stress source.

STRESS: CHANNEL DEFINITION 94JAN01 01:30PM

*CHANNELS					*SMU/PG SELECTOR	
UNIT	MEASURE	MODE	STRESS	NAME	FCTN	
SMU1:MP	V1					1 SMU PGU
SMU2:MP	V2					2 SMU PGU
SMU3:MP	V3					3 OPEN OPEN
SMU4:MP						4 OPEN OPEN
SMU5:MP						
SMU6:MP						
VSU1						
VSU2						
PGU1		VPULSE			SYNC	*TRIGGER SETUP
PGU2		VPULSE			SYNC	DISABLE
GNDU						PCLARITY POSITIVE

SYNC

NSYNC

DELETE ROW

SYND

CHANNEL DEF STRESS SETUP STRESS FORCE [] [] [] [] NEXT PAGE

UG19011,100x70

Making a Measurement
Stress Force

To Set up Stress Condition/Timing

1. Press Stress key in the PAGE CONTROL key group.
2. Select STRESS SETUP primary softkey.
3. In the MODE field of the STRESS MODE area, select:
 - DURATION secondary softkey to specify how long to force stress.
 - PULSE COUNT secondary softkey to specify how many pulses to output for force stress (for ac stress only).
4. In the DURATION or PULSE COUNT field, enter the duration or pulse count. You can select FREE RUN secondary softkey to output stress continuously.
5. In the STRESS Status field, select:
 - CONT AT ANY secondary softkey to continue forcing the stress even if an abnormal status occurs.
 - STOP AT ANY ABNORM secondary softkey to stop forcing the stress when any abnormal status occurs.
 - STOP AT COMPLIANCE secondary softkey to stop forcing the stress only when SMU reaches its compliance setting.

STOP AT ANY ABNORM and STOP AT COMPLIANCE secondary softkeys are displayed only when specified duration is more than 10 s. If you set pulse count mode, these secondary softkeys are displayed only when *pulse period* × *pulse count* is more than 10 s.

Stress stop function is not effective until stress has been forced for 10 s.

In the duration mode, you set time (in seconds) for stress forcing. In the pulse count mode, you set an integer to specify how many pulses to output for stress forcing.

Abnormal status means the following:

- SMU reaches its compliance setting.
- Current of VSU exceeds ± 100 mA.
- SMU or VSU oscillates.
- A/D converter overflow occurs.
- Average current of PGU exceeds ± 100 mA.

Making a Measurement Stress Force

To set hold time

In the HOLD TIME field, set desired value. For the meaning of hold time, see “Stress Force Sequence” in Chapter 3.

Setting the Accumulated Stress Time

The ACCUMULATED STRESS field shows the total stress that has been forced. If necessary, you can change the value in this field. If so, the ACCUMULATED STRESS field on the STRESS: STRESS FORCE screen also changes to the new value.

Example

The following figure shows an example setup of stress condition.

STRESS: STRESS SETUP 94JAN01 01:30PM

*STRESS MODE		*PULSE		DURATION	
DURATION 1.0ms		UNIT	PGU1	PGU2	PULSE COUNT
*ACCUMULATED STRESS 0.0000s		NAME			
*HOLD TIME 0.000 s		PERIOD	10.00ms	-----	
*FILTER ON		WIDTH	5.00ms	5.00ms	
*STRESS CONTINUE AT ANY Status		DELAY TIME	0.00000 s	0.00000 s	
*CONSTANT		PEAK VALUE	100mV	100mV	
UNIT		BASE VALUE	0.000 V	0.000 V	
NAME		LEADING TIME	200.ns	200.ns	
MODE		TRAILING TIME	100.ns	100.ns	
SOURCE		IMPEDANCE	LOW	LOW	
COMPLIANCE					
DURATION					
CHANNEL DEF	STRESS SETUP	STRESS FORCE			PREV PAGE NEXT PAGE

UG01012, 100x70

Making a Measurement
Stress Force

To Set up AC (Pulse) Stress

1. Press the Stress key in the PAGE CONTROL key group. Confirm that the following is set on the STRESS: CHANNEL DEFINITION screen for the *PGUs* that you want to set up for ac stress:
 - VPULSE is set in the MODE field.
 - SYNC is set in the FCTN field.
2. Select STRESS SETUP primary softkey.
3. In the PERIOD field, enter the pulse period.
4. In the WIDTH field, enter the pulse width.
5. In the DELAY TIME field, enter the delay time, which is the time from the stress start to the beginning of the pulse leading edge. See “Delay time” on page 4-55.
6. In the PEAK VALUE field, enter the pulse peak value.
7. In the BASE VALUE field, enter the pulse base value.
8. In LEADING TIME field, enter the leading-edge transition time of pulse.
9. In TRAILING TIME field, enter the trailing-edge transition time of pulse.

The same period you set for PGU1 is also used for PGU2. For the other parameters, you can set different values for PGU1 and PGU2.

To set other areas of the STRESS: STRESS SETUP screen, see “To Set up Stress Condition/Timing” on page 4-52.

To modify the UNIT and NAME fields

Modify UNIT and NAME fields on STRESS: CHANNEL DEFINITION screen.

To set output impedance of PGU1 or PGU2

In the IMPEDANCE field, select:

- LOW secondary softkey to set output impedance to low (approximately zero).
- 50 ohm secondary softkey to set output impedance to 50 Ω .

Making a Measurement
Stress Force

Delay time

The following figure shows the meaning of delay time.

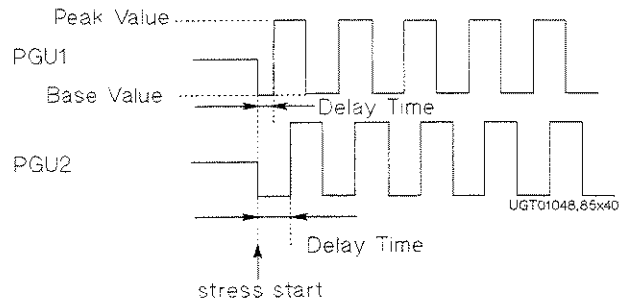

Example

The following figure shows an example to set up ac stress.

STRESS: STRESS SETUP 94JAN01 01:30PM

*STRESS MODE	*PULSE		
DURATION	UNIT	PGU1	PGU2
1.0ms	NAME	10.00ms	-----
	PERIOD	5.00ms	5.00ms
*ACCUMULATED STRESS	WIDTH	0.0000 s	0.0000 s
0.0000s	DELAY TIME	0.0000 s	0.0000 s
	PEAK VALUE	100mV	100mV
*HOLD TIME	BASE VALUE	0.000 V	0.000 V
0.000 s	LEADING TIME	100 ns	100 ns
	TRAILING TIME	100 ns	100 ns
*FILTER	IMPEDANCE	LOW	LOW
ON			
*STRESS	CONTINUE AT ANY Status		
*CONSTANT			
UNIT	SMU1: MP		
NAME	VSU		
MODE	V		
SOURCE	5.00 V		
COMPLIANCE	1.0000mA		

0.000000100

CH-CHANNEL DEF STRESS SETUP STRESS FORCE PREV PAGE NEXT PAGE

**Making a Measurement
Stress Force**

To Set up DC Stress

1. Press Stress key in the PAGE CONTROL key group. Confirm that the following is set on the STRESS: CHANNEL DEFINITION screen for the units that you want to set up for dc stress:
 - V or I is set in the MODE field.
 - SYNC is set in the FCTN field.
2. Select STRESS SETUP primary softkey.
3. In the SOURCE field for the desired unit in the CONSTANT area, enter the desired dc stress value.
4. In the COMPLIANCE field in the CONSTANT area, enter the compliance value.

The non-stress (NSYNC) constant units also appear in the CONSTANT area. You can set SOURCE and COMPLIANCE values for these units the same way as you set the dc stress units.

To set other areas of the STRESS: STRESS SETUP screen, see “To Set up Stress Condition/Timing” on page 4-52.

To modify the UNIT, NAME, and MODE fields

Modify the UNIT, NAME, and MODE fields on the STRESS: CHANNEL DEFINITION screen.

Example

The following figure shows an example setup to set source (SMU1) to 5.00 V and compliance (SMU1) to 1.00 mA.

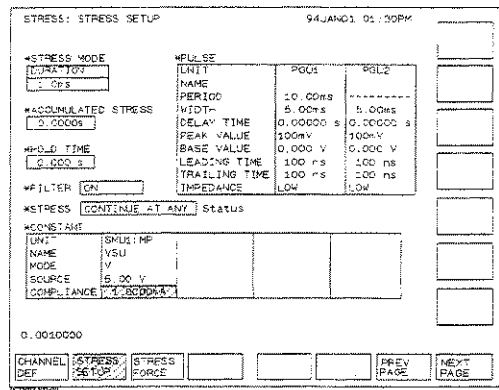

To Force Stress

Press Stress key in the MEASUREMENT key group.

The STRESS area shows the specified stress duration time. Even if you set STRESS MODE to PULSE COUNT, the stress duration time is calculated and shown in seconds.

The ACCUMULATED STRESS area shows the total stress that has already been forced.

To change the stress time (duration mode)

Select CHANGE DURATON secondary softkey, then enter desired value.

The CHANGE DURATON secondary softkey is displayed only if the DURATION mode is selected on the STRESS: STRESS SETUP screen.

To change pulse count (pulse count mode)

Select CHANGE PLS CNT secondary softkey, then enter desired value.

The CHANGE PLS CNT secondary softkey is displayed only if the PULSE COUNT mode is selected on the STRESS: STRESS SETUP screen.

To reset STATUS value to 0 s and 0 %

Select RESET STATUS secondary softkey.

To reset ACCUMULATED STRESS value to 0 s

Select RESET ACCUM STRESS secondary softkey.

To change ACCUMULATED STRESS value

On the STRESS: STRESS SETUP screen, enter the desired value in the ACCUMULATED STRESS field.

To Control Selector for Switching SMU and PGU

1. Press Stress key in the PAGE CONTROL key group.
2. Select CHANNEL DEF primary softkey.
3. In the MEASURE field of the desired channel in the SMU/PG SELECTOR area, select:
 - SMU secondary softkey to connect SMU to DUT during measurement state.
 - PGU secondary softkey to connect PGU to DUT during measurement state.
 - OPEN secondary softkey to disconnect SMU, PGU, and DUT during measurement state.
 - PGU OPEN secondary softkey to disconnect PGU from DUT by semiconductor switch during measurement state.
4. In the STRESS field of the desired channel in the SMU/PG SELECTOR area, select:
 - SMU secondary softkey to connect SMU to DUT during stress force state.
 - PGU secondary softkey to connect PGU to DUT during stress force state.
 - OPEN secondary softkey to disconnect SMU, PGU, and DUT during stress force state.
 - PGU OPEN secondary softkey to disconnect PGU from DUT by semiconductor switch during stress force state.

Making a Measurement
Stress Force

SMU/Pulse Generator Selector

The selector has two types of switches: relay switch and semiconductor switch. Normally, the relay switch has three states: SMU is connected to DUT, PGU is connected to DUT, and neither is connected to DUT. The semiconductor switch, which is in the PGU line, is used for high-speed switching.

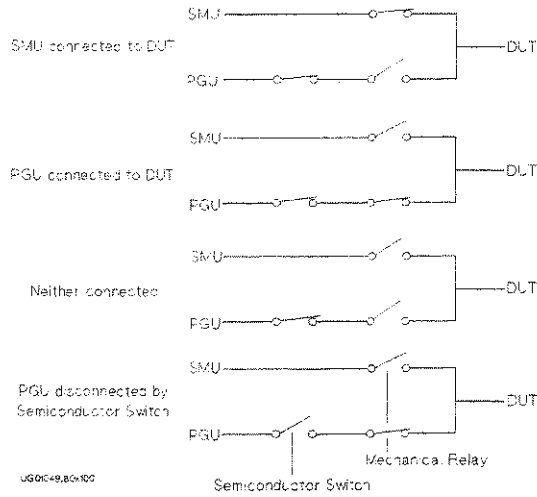

Example

Following shows an example setup that connects two SMUs to DUT during measurement state, and connects two PGUs to DUT during stress force state.

STRESS: CHANNEL DEFINITION 94JAN01 01:30PM

*CHANNELS					*SMU/PG SELECTOR		
UNIT	MEASURE	MODE	STRESS	NAME	FCTN	MEASURE	STRESS
SMU1:MP	V1					1 SMU	PGU
SMU2:MP	V2					2 SMU	PGU
SMU3:MP	V3					3 OPEN	OPEN
SMU4:MP						4 OPEN	OPEN
SMU5:MP							
SMU6:MP							
VSU1							
VSU2							
PGU1		VPULSE		SYNC			
PGU2		VPULSE					
GNDU							

*TRIGGER SETUP
 DISABLE
 POLARITY POSITIVE

PGU

CHANEL DEF. STRESS SETUP STRESS FORCE

0610164.000/0

Analyzing Measurement Results

Agilent 4155B/4156B can analyze measurement results of the GRAPH/LIST screen group by using lines, markers, and cursors. You can perform manual or automatic analysis.

For automatic analysis function, you set up the DISPLAY: ANALYSIS SETUP screen before starting measurements. Then, after the measurements are performed, the lines and markers are positioned automatically according to the setup.

The information about these functions is organized into the following two sections:

- “Manual Analysis”
- “Automatic Analysis”

For details about line modes and specifying points, refer to Chapter 7. Also, see “GRAPH/LIST Screen Group” in Chapter 6.

Manual Analysis

You can position lines, markers, and cursors by using front-panel keys, rotary knob, and softkeys.

This section covers the following manual analysis tasks:

- Marker and cursor:**
- “To Specify a Measurement Point on Curve” on page 5-4
 - “To Specify between Measurement Points on Curve” on page 5-6
 - “To Display or Move Cursor” on page 5-8
- Display range:**
- “To Adjust Display Range to Measurement Curve Automatically” on page 5-9
 - “To Zoom the Display Range” on page 5-9
 - “To Center Display at Cursor Location” on page 5-10
- Line:**
- “To Draw Line through Two Specified Points” on page 5-10
 - “To Draw Line through Specified Point with Specified Gradient” on page 5-12
 - “To Draw Tangent to Specified Point of Measurement Curve” on page 5-14
 - “To Draw Regression Line for Specified Region” on page 5-16
 - “To Display and Select a Line” on page 5-18
- Another graph functions:**
- “To Display Grid on the Graph” on page 5-18
 - “To Change Data Variable on Graph” on page 5-19
 - “To Change Range of X or Y Axis Scale” on page 5-20
 - “To Change Variable Assigned to X, Y1, or Y2 Axis” on page 5-21
 - “To Overlay an Internal Memory Measurement Curve onto Plotting Area” on page 5-22
- Analysis on the LIST screen:**
- “To Scroll the LIST screen” on page 5-24
 - “To Display or Move Marker on LIST screen” on page 5-25
 - “To Change Variables of LIST screen” on page 5-26

Analyzing Measurement Results
Manual Analysis

To Specify a Measurement Point on Curve

1. Select MARKER/CURSORS primary softkey.
2. Set MARKER secondary softkey to ON. Marker and marker coordinates are displayed. Selecting MARKER secondary softkey toggles between ON and OFF.
3. (if both Y1 and Y2 axis are set up) Select the desired marker (axis) by using AXIS primary softkey. The selected marker is highlighted. Selecting AXIS primary softkey toggles between Y1 and Y2.
4. Rotate the rotary knob to move the marker to desired measurement point.

If both Y1 and Y2 axis are set up, a circle marker (o) is displayed on measurement curve of Y1 axis, and an asterisk marker (*) is displayed on measurement curve of Y2 axis.

The MARKER coordinate fields indicate the location of markers. The first, second, and third fields are X, Y1, and Y2 coordinates, respectively. X and Y1 indicate location of marker on Y1 curve. X and Y2 indicate location of marker on Y2 curve.

To turn off markers

Set MARKER secondary softkey to OFF.

To move marker to maximum or minimum value of measurement curve

Select MARKER MIN/MAX secondary softkey. The marker searches for minimum or maximum value in measurement order from the present location every time you select the MARKER MIN/MAX secondary softkey.

To move marker to next VAR2 step or append curve

Select MARKER SKIP secondary softkey. Marker moves to next VAR2 step curve or next append curve every time you select MARKER SKIP secondary softkey.

To move marker fast

Press Fast front-panel key of the MARKER/CURSORS key group while rotating rotary knob.

Example

The following figure shows an example to move marker to desired measurement point and to set the Y1 axis marker to active.

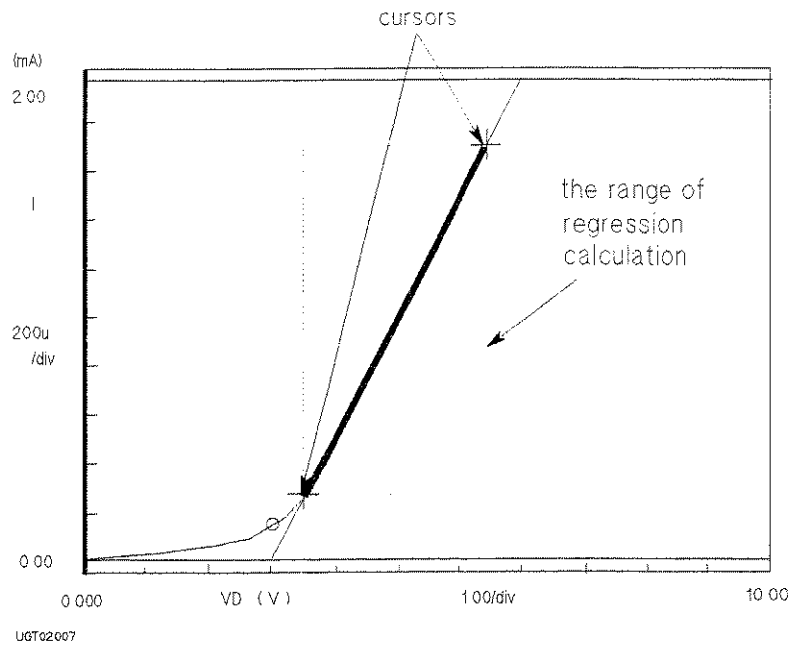

Analyzing Measurement Results
Manual Analysis

To Specify between Measurement Points on Curve

1. Select MARKER/CURSOR primary softkey.
2. Set MARKER secondary softkey to ON. Marker and marker coordinates are displayed. Selecting MARKER toggles between ON and OFF.
3. (if both Y1 and Y2 axis are set up) Select the desired marker (axis) by using AXIS primary softkey. The selected marker is highlighted. Selecting AXIS primary softkey toggles between Y1 and Y2.
4. Set INTERPOLATE secondary softkey to ON. Selecting INTERPOLATE secondary softkey toggles between ON and OFF.
5. Rotate rotary knob to move the marker to desired measurement point.

If both Y1 and Y2 axis are set up, a circle marker (o) is displayed on measurement curve of Y1 axis, and an asterisk marker (*) is displayed on measurement curve of Y2 axis.

The MARKER coordinate fields indicate the location of markers. The first, second, and third fields are X, Y1, and Y2 coordinates, respectively. X and Y1 indicate location of marker on Y1 curve. X and Y2 indicate location of marker on Y2 curve.

To turn off markers

Set the MARKER secondary softkey to OFF.

To move marker to maximum or minimum value of measurement curve

Select MARKER MIN/MAX secondary softkey. The marker searches for minimum or maximum value in measurement order from the present location every time you select the MARKER MIN/MAX secondary softkey.

To move marker to next VAR2 step or append curve

Select MARKER SKIP secondary softkey. Marker moves to next VAR2 step curve or next append curve every time you select MARKER SKIP.

To move marker fast

Press Fast front-panel key of the MARKER/CURSOR key group while rotating rotary knob.

Analyzing Measurement Results Manual Analysis

Example

The following figure shows an example to move marker to points between measurement points by setting INTERPOLATE softkey to ON.

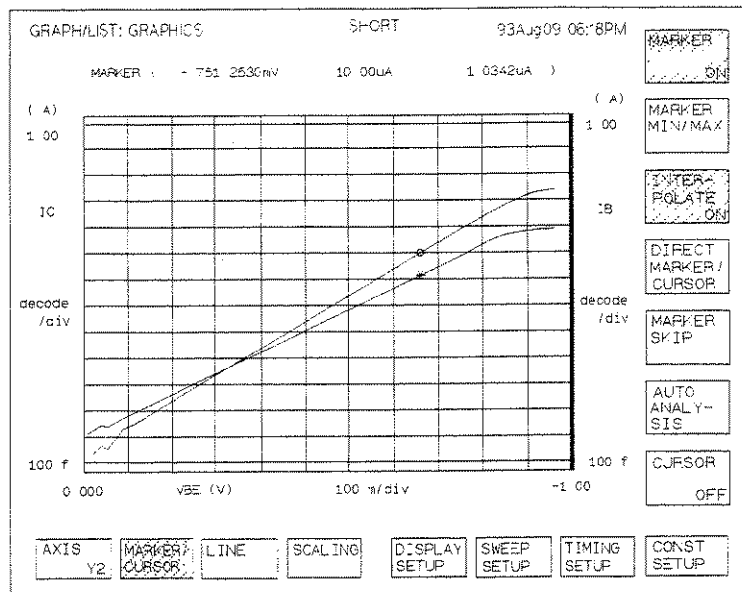

UGT02002

Analyzing Measurement Results

Manual Analysis

To Display or Move Cursor

1. Select MARKER/CURSOR primary softkey.
2. Set CURSOR secondary softkey to SHORT or LONG. Short or long cursor and cursor coordinates are displayed. Selecting CURSOR secondary softkey toggles as follows:

OFF → SHORT → LONG → OFF

3. Move the cursor by using arrow keys of the MARKER/CURSOR key group.

The CURSOR coordinate fields indicate the location of cursor. The first, second, and third fields are X, Y1, and Y2 coordinates, respectively.

To move cursor diagonally

Press two adjacent arrow keys of the MARKER/CURSOR key group simultaneously.

To turn off cursor

Set CURSOR secondary softkey to OFF.

To move cursor fast

Press arrow keys and Fast key of the MARKER/CURSOR key group simultaneously.

Example

The following figure shows an example to display a short cursor.

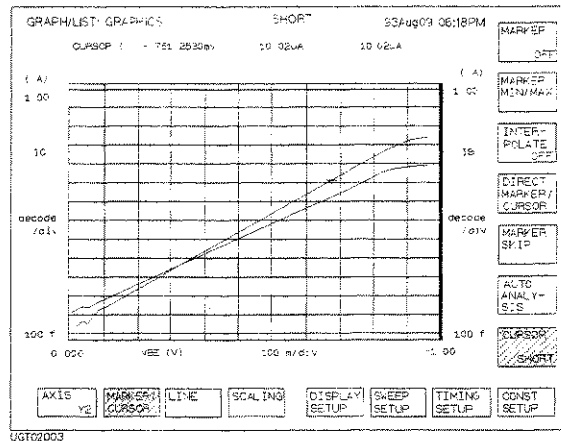

To Adjust Display Range to Measurement Curve Automatically

1. Select SCALING primary softkey.
2. (if both Y1 and Y2 axis are set up) Select desired measurement curve by using AXIS primary softkey.
3. Select AUTO SCALING secondary softkey. Scale is changed automatically to fit the selected measurement curve.

When you set VAR2 parameter, or when you perform append measurement, the scale is changed so that all measurement curves can be displayed.

To cancel auto scaling

Select CANCEL SCALING secondary softkey.

To Zoom the Display Range

1. Position the cursor at the center of area that you want to zoom. (For details about displaying and moving cursor, see "To Display or Move Cursor" on page 5-8.)
2. Select SCALING primary softkey.
3. Select:
 - ZOOM IN secondary softkey to decrease the display range to half the present range.
 - ZOOM OUT secondary softkey to increase the display range to double the present range.
 - The display range is increased or decreased, and cursor is moved to the center of the plotting area.

If no cursor is displayed before step 3, performing step 3 displays a long cursor at the center of the plotting area, then zoom is performed.

To return to original scaling

Select CANCEL SCALING secondary softkey.

Analyzing Measurement Results
Manual Analysis

To Center Display at Cursor Location

1. Position cursor at the point where you want to center the plotting area. (For details about displaying and moving cursor, see “To Display or Move Cursor” on page 5-8.)
2. Select SCALING primary softkey.
3. (if both Y1 and Y2 axis are set up) Select desired measurement curve by using AXIS primary softkey.
4. Select CENTER AT CURSOR secondary softkey. The plotting area is centered around the cursor location.

If no cursor is displayed before step 4, performing step 4 displays a long cursor at the center of the plotting area.

To return plotting area to original position

Select CANCEL SCALING secondary softkey.

To Draw Line through Two Specified Points

1. Select LINE primary softkey.
2. Set LINE SELECT softkey to 1 or 2. Selecting this softkey toggles the setting.
3. Set LINE secondary softkey to ON. A line and two cursors are displayed. Selecting LINE secondary softkey toggles as follows:

OFF → ON → OFF

The line mode should be normal. So (GRAD MODE, TANGENT MODE, or REGRESS MODE) softkeys should not be highlighted. If one of these softkeys is highlighted, turn off by pressing the softkey.

4. Move cursors to desired locations by using arrow keys of the MARKER/CURSOR key group. To select the cursor you want to move, use the SELECT CURSOR secondary softkey.

If it seems that only one cursor is displayed, the cursors are at the same location.

When lines are displayed and when ON is set in the LINE PARAMETER field on the DISPLAY: DISPLAY SETUP screen, their X and Y intercepts and gradients are also displayed in the plotting area.

Analyzing Measurement Results
Manual Analysis

To Draw Line through Specified Point with Specified Gradient

1. Select LINE primary softkey.
2. Set LINE SELECT softkey to 1 or 2. Selecting this softkey toggles the setting.
3. Set LINE secondary softkey to ON. A line and two cursors are displayed. Selecting LINE secondary softkey toggles as follows:
OFF → ON → OFF
4. Select GRAD MODE secondary softkey if it is not highlighted. Softkey becomes highlighted. One cursor disappears (if there are two cursors in the plotting area before this step). Selecting GRAD MODE secondary softkey toggles between highlighted and not highlighted.
5. Move the cursor to desired location by using arrow keys of the MARKER/CURSOR key group.
6. Select GRAD VALUE secondary softkey, then enter gradient value. The line goes through the cursor with specified gradient.

When lines are displayed and when ON is set in the LINE PARAMETER field on the DISPLAY: DISPLAY SETUP screen, the X and Y intercepts and gradients of selected line are also displayed in the plotting area.

To turn off the line intercept and gradient display

Select DISPLAY SETUP primary softkey, then set LINE PRMTRS secondary softkey to OFF.

To turn off the data variable display area

Use the following procedure:

1. Select DISPLAY SETUP primary softkey.
2. Set DATA VAR secondary softkey to OFF.

To move the selected cursor to the selected marker position

Select CURSOR TO MARKER secondary softkey.

Analyzing Measurement Results Manual Analysis

Example

The following figure shows an example to draw a line through specified point with specified gradient.

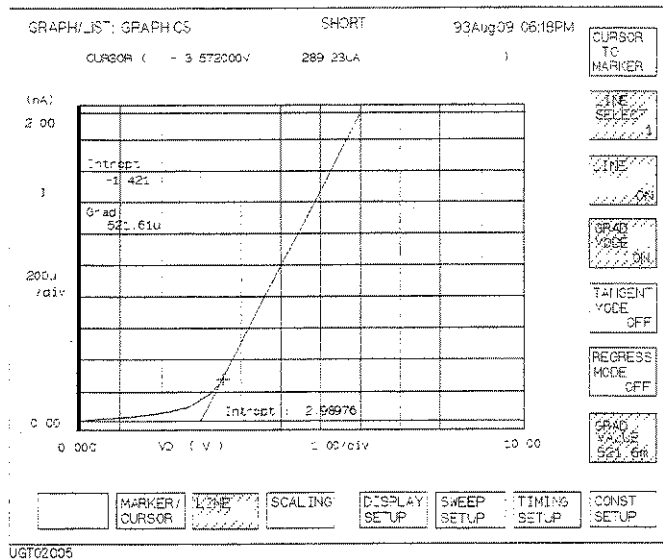

Analyzing Measurement Results
Manual Analysis

To Draw Tangent to Specified Point of Measurement Curve

1. Press LINE primary softkey.
2. Set LINE SELECT softkey to 1 or 2. Selecting this softkey toggles the setting.
3. Set LINE secondary softkey to ON. A line and two cursors are displayed. Selecting the LINE secondary softkey toggles as follows:
OFF → ON → OFF
4. Select TANGENT MODE secondary softkey if it is not highlighted. Softkey becomes highlighted. The cursors disappear and marker appears. Selecting TANGENT MODE toggles between highlighted and not highlighted.
5. Move marker to the desired measurement point by rotating rotary knob.

When lines are displayed and when ON is set in the LINE PARAMETER field on the DISPLAY: DISPLAY SETUP screen, the X and Y intercepts and gradients of selected line are also displayed in the plotting area.

To move marker to next VAR2 or next append curve

Select MARKER SKIP secondary softkey. Marker moves to next VAR2 step curve or next append curve every time you press MARKER SKIP.

To turn off the line intercept and gradient display

Select DISPLAY SETUP primary softkey, then set LINE PRMTRS secondary softkey to OFF.

To turn off the data variable display area

Use the following procedure:

1. Select DISPLAY SETUP primary softkey.
2. Set DATA VAR secondary softkey to OFF.

To move marker between two adjacent measurement points

See "To Specify between Measurement Points on Curve" on page 5-6.

Analyzing Measurement Results
Manual Analysis

To Draw Regression Line for Specified Region

1. Select MARKER/CURSOR primary softkey, then set the MARKER secondary softkey to ON.
2. Select the desired axis for regression calculation by selecting AXIS primary softkey (if both Y1 and Y2 axis are set up). Then, if necessary, move marker to desired measurement curve by selecting MARKER SKIP secondary softkey.
3. Select LINE primary softkey.
4. Set LINE SELECT softkey to 1 or 2. Selecting this softkey toggles the setting.
5. Set LINE secondary softkey to ON. A line and two cursors are displayed. Selecting LINE secondary softkey toggles as follows:
OFF → ON → OFF
6. Select REGRESS MODE secondary softkey if it is not highlighted. Softkey becomes highlighted. Selecting REGRESS MODE secondary softkey toggles between highlighted and not highlighted.
7. Move cursors to specify range of regression calculation. (Use arrow keys of the MARKER/CURSOR key group to move cursors to desired location.)
 - To select the cursor you want to move, use the SELECT CURSOR secondary softkey.

The range used for calculating the regression line is defined by the position of the two cursors as shown in the following figure.

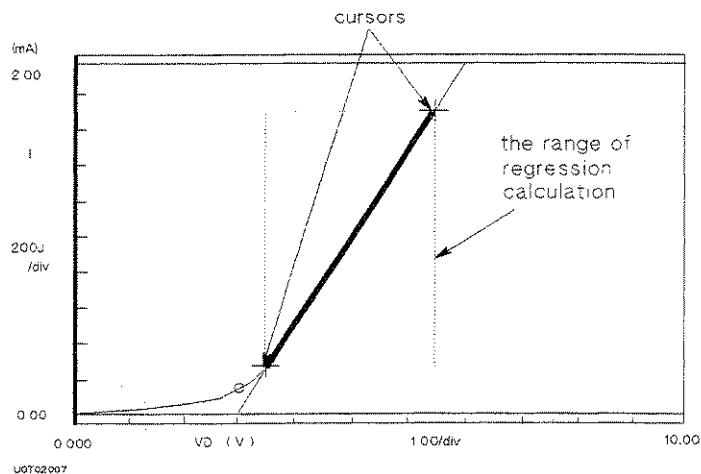

Analyzing Measurement Results Manual Analysis

If it seems that only one cursor is displayed, the cursors are at the same location.

When regression lines are displayed and when ON is set in the LINE PARAMETER field on the DISPLAY: DISPLAY SETUP screen, the X and Y intercepts and gradient of selected line are also displayed in the plotting area.

To turn off the line intercept and gradient display

Select DISPLAY SETUP primary softkey, then set LINE PRMTRS secondary softkey to OFF.

To turn off the data variable display area

Use the following procedure:

1. Select DISPLAY SETUP primary softkey.
2. Set DATA VAR secondary softkey to OFF.

To move selected cursor to the selected marker position

Select CURSOR TO MARKER secondary softkey.

Example

The following figure shows an example to draw a regression line for the specified region.

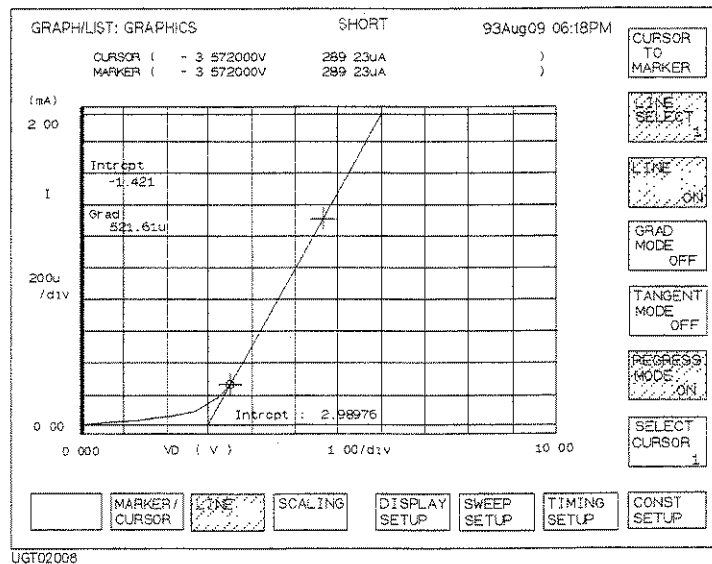

Analyzing Measurement Results
Manual Analysis

To Display and Select a Line

1. Select LINE primary softkey.
2. Set LINE SELECT softkey to 1 or 2. Selecting this softkey toggles the setting.
3. Set LINE secondary softkey to ON. Selected line and two cursors are displayed. Selecting the LINE secondary softkey toggles as follows:

OFF → ON → OFF

Set LINE SELECT secondary softkey to desired line (1 or 2). Selected line is highlighted.

To select line to analyze

Selecting LINE SELECT secondary softkey toggles as follows:

1 → 2 → NONE → 1

The following are independent for each line. So, changing the active line also changes the following:

- locations of marker and cursors
- X and Y intercepts and gradient

To Display Grid on the Graph

1. Select DISPLAY SETUP primary softkey.
2. Set GRID secondary softkey to ON. Grid is displayed. Selecting GRID secondary softkey toggles between ON and OFF.

To turn off grid

Set GRID secondary softkey to OFF.

To Change Data Variable on Graph

1. Select DISPLAY SETUP primary softkey.
2. Select RE-SETUP GRAPH secondary softkey.
3. Move the pointer to desired data variable field by using the arrow keys, then select secondary softkey to enter the desired variable name.
4. Select EXIT primary softkey to exit the RE-SETUP GRAPH mode.

To exit without changing data variable

Select CANCEL primary softkey.

Example

The following figure shows an example setup to change the data variable to be displayed.

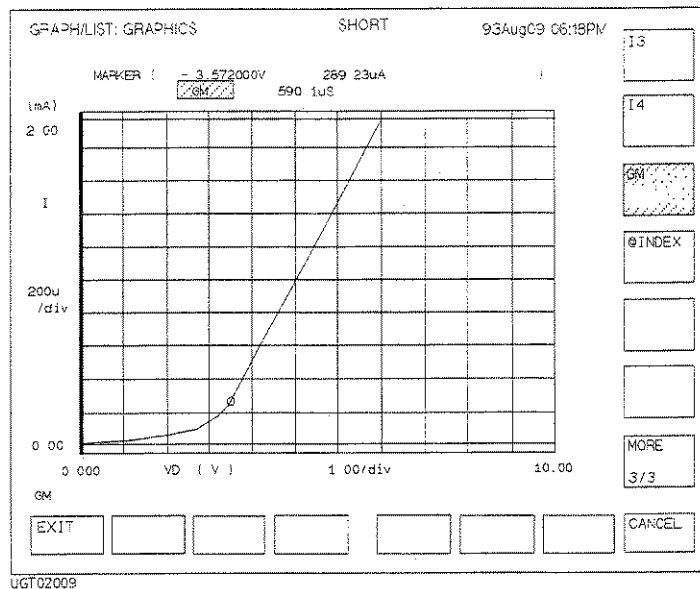

Analyzing Measurement Results
Manual Analysis

To Change Range of X or Y Axis Scale

1. Select DISPLAY SETUP primary softkey.
2. Select RE-SETUP GRAPH secondary softkey.
3. Move pointer to maximum or minimum value field of X or Y axis scale by using the arrow keys, then edit the setup value by using ENTRY keys or rotary knob.
4. Select EXIT primary softkey to exit RE-SETUP GRAPH mode.

To exit without changing range of X or Y axis scale

Select CANCEL primary softkey.

Example

The following figure shows an example setup to change maximum value of Y1 axis.

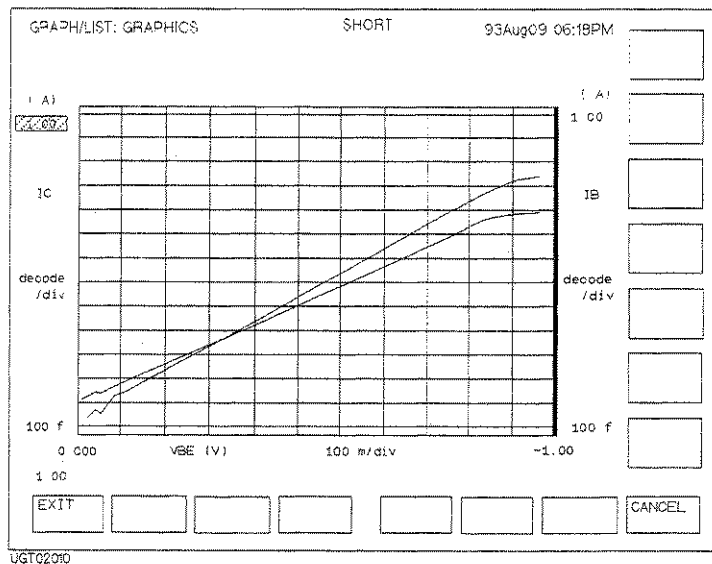

To Change Variable Assigned to X, Y1, or Y2 Axis

1. Select DISPLAY SETUP primary softkey.
2. Select RE-SETUP GRAPH secondary softkey.
3. Move pointer to variable field of X, Y1, or Y2 axis by using arrow keys, then select secondary softkey to set the desired variable.
4. Select EXIT primary softkey to exit RE-SETUP GRAPH mode.

To exit without changing variable assigned to X, Y1, or Y2 axis

Select CANCEL primary softkey.

Example

The following figure shows an example setup to change the variable that is assigned to Y1 axis.

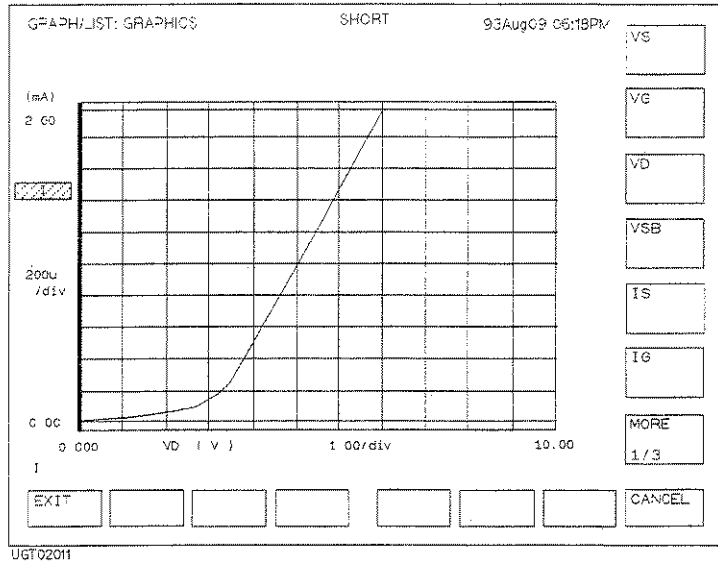

Analyzing Measurement Results
Manual Analysis

To Overlay an Internal Memory Measurement Curve onto Plotting Area

This section explains how to overlay a measurement curve (that was stored into an internal memory) onto plotting area. To store a measurement curve into an internal memory, refer to Chapter 3 of *User's Guide General Information*.

1. Select DISPLAY SETUP primary softkey.
2. Set OVERLAY PLANE secondary softkey to the desired memory number. Selected measurement curve is overlaid onto plotting area. Selecting OVERLAY PLANE secondary softkey toggles as follows:

OFF → 1 → 2 → 3 → 4 → OFF

To display information of overlay measurement curve

Select SHOW OVERLAY INFO secondary softkey. The following information of overlay measurement curve overwrites the information of the present curve.

- axis names and axis scales
- cursor and marker coordinates
- data variables

To display information of original curve again, select the EXIT primary softkey.

To change the present scale to the same scale as overlay curve

Select SCALE TO OVERLAY secondary softkey.

To return to the original scale, you need to select SCALING primary softkey, then select CANCEL SCALING secondary softkey.

Analyzing Measurement Results Manual Analysis

Example

The following figure shows an example to overlay a measurement curve (that is stored in internal memory 1) onto the presently displayed measurement curve.

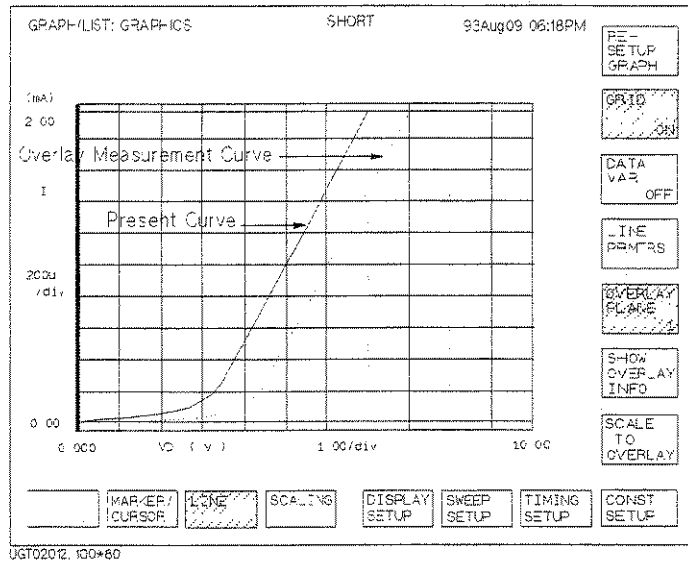

Analyzing Measurement Results
Manual Analysis

To Scroll the LIST screen

- Press an arrow key of the MARKER/CURSOR key group. List scrolls in direction of selected arrow.

List can be scrolled even while performing measurements.

When marker is displayed, marker does not move during scrolling.

To scroll list fast

Press Fast key of the MARKER/CURSOR key group while pressing an arrow key of the MARKER/CURSOR key group.

To Display or Move Marker on LIST screen

1. Select MARKER primary softkey.
2. Set MARKER secondary softkey to ON. The marker is displayed. Selecting MARKER secondary softkey toggles between ON and OFF.
3. Rotate rotary knob to move the marker to desired measurement point.

To turn off marker

Set MARKER secondary softkey to OFF.

To move marker to next VAR2 step

Select MARKER SKIP secondary softkey. Marker moves to next VAR2 step data or next append data every time you select MARKER SKIP secondary softkey.

To move marker to next append data

Select NEXT APPEND secondary softkey. Marker moves to next append data every time you select NEXT APPEND secondary softkey.

Example

The following figure shows an example to display marker.

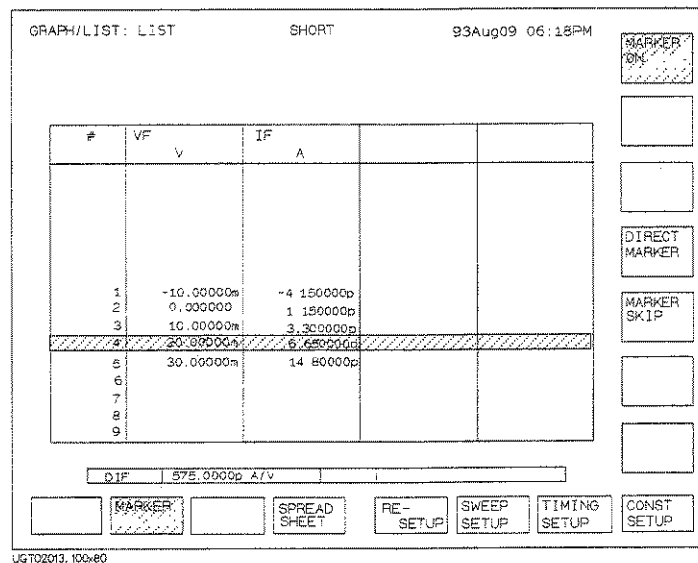

Analyzing Measurement Results
Manual Analysis

To Change Variables of LIST screen

1. Select RE-SETUP primary softkey.
2. Move pointer to desired column variable or data variable field by using arrow keys, then select secondary softkey of desired variable.
3. Select EXIT primary softkey to exit RE-SETUP LIST mode.

To exit without changing LIST variables

Select CANCEL primary softkey.

Example

The following figure shows an example to change the LIST variables.

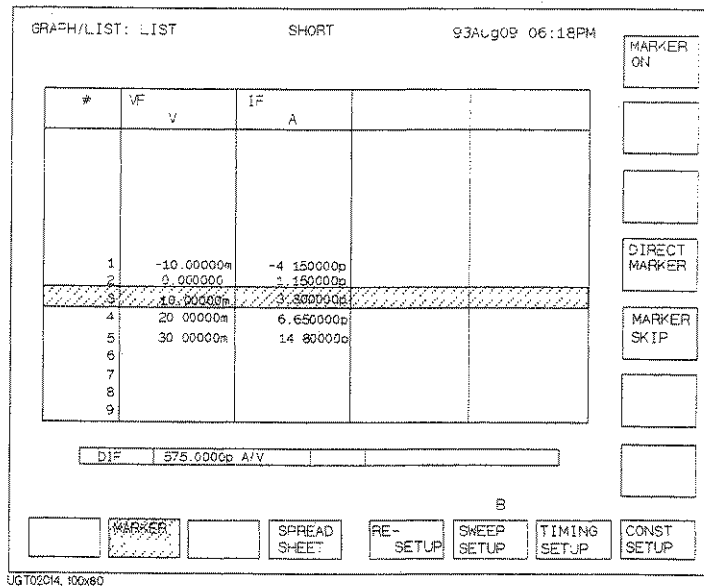

Automatic Analysis

You set up automatic analysis before the measurement by using the DISPLAY: ANALYSIS SETUP screen. Then, after measurement is performed, the marker and lines are automatically positioned according to automatic analysis setup.

This section covers the following automatic analysis tasks:

- “To Draw Line by Specifying Two Points” on page 5-28
- “To Draw Line by Specifying Gradient and One Point” on page 5-30
- “To Draw Tangent to Specified Measurement Point” on page 5-32
- “To Draw Regression Line by Specifying Two Points” on page 5-34
- “To Display Marker at Specified Point” on page 5-37

Analyzing Measurement Results
Automatic Analysis

To Draw Line by Specifying Two Points

1. Press Display front-panel key.
2. Confirm that ON is set on the LINE *secondary* softkey on the GRAPH/LIST: GRAPHICS screen.
3. Select ANALYSIS SETUP primary softkey. The DISPLAY: ANALYSIS SETUP screen is displayed.
4. In field (1), select NORMAL secondary softkey.
5. In field (2), select secondary softkey to specify desired axis.
6. In field (3), select:
 - BY X-Y COORDINATE secondary softkey to specify a point by X-Y coordinate mode. (Go to step 6.)
 - BY DATA CONDITION secondary softkey to specify a point by data condition mode. (Go to step 7.)
7. If you selected BY X-Y COORDINATE secondary softkey:
 - a. In the X field, enter desired expression to specify X coordinate.
 - b. In the Y field, enter desired expression to specify Y coordinate.
 - c. Go to step 8.
8. If you selected BY DATA CONDITION secondary softkey:
 - a. In field (4), select secondary softkey to set desired data variable name.
 - b. In field (5), enter desired expression.
 - c. In field (6), select:
 - AFTER secondary softkey if you want to set a search start condition for finding specified point.
 - DISABLE secondary softkey to disable (clear) the AFTER settings.
 - d. If you selected AFTER, select secondary softkey to enter desired data variable in field (7).
 - e. If you selected AFTER, enter desired expression in field (8).
9. Specify the other point by step 5, then step 6 or 7.

Analyzing Measurement Results Automatic Analysis

Data condition mode specifies a point related to the measurement curve. So, if no measurement data satisfy the specified condition, the nearest measurement point is used.

For the meaning of expression that you can enter in step 6 or 7, see “Expression” in Chapter 7.

To specify a point between two measurement points

Set Interpolate field to ON.

To disable (clear) the settings

Move the pointer to field (1), then select DISABLE secondary softkey. Setup fields disappear.

Example

The following figure shows an example setup to automatically draw a line through two specified points. One point is specified by X-Y coordinate mode and other point is specified by data condition mode.

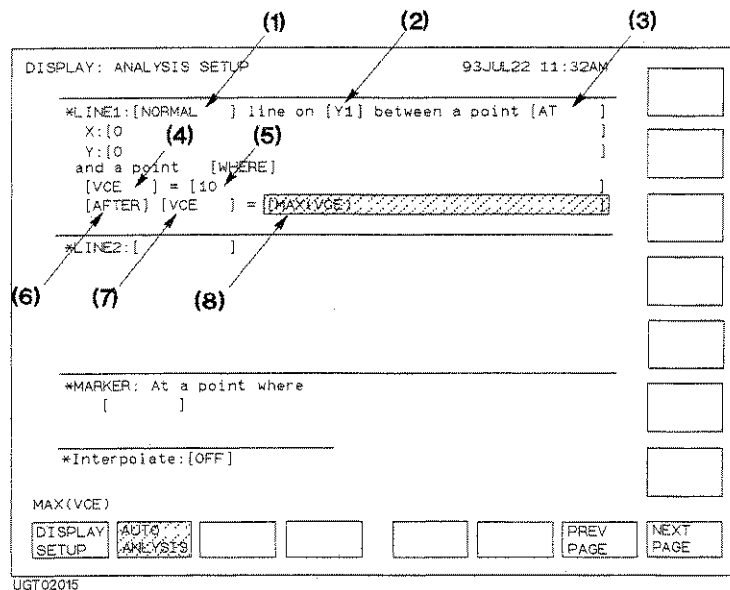

Analyzing Measurement Results
Automatic Analysis

To Draw Line by Specifying Gradient and One Point

1. Press Display front-panel key.
2. Confirm that ON is set on the LINE *secondary* softkey on the GRAPH/LIST: GRAPHICS screen.
3. Select ANALYSIS SETUP primary softkey. The DISPLAY: ANALYSIS SETUP screen is displayed.
4. In field (1), select GRAD secondary softkey.
5. In field (2), select secondary softkey to specify desired axis.
6. In field (3), select:
 - BY X-Y COORDINATE secondary softkey to specify a point by X-Y coordinate mode. (Go to step 6.)
 - BY DATA CONDITION secondary softkey to specify a point by data condition mode. (Go to step 7.)
7. If you selected BY X-Y COORDINATE secondary softkey:
 - a. In the X field, enter desired expression to specify X coordinate.
 - b. In the Y field, enter desired expression to specify Y coordinate.
 - c. Go to step 8.
8. If you selected BY DATA CONDITION secondary softkey:
 - a. In field (4), select secondary softkey to set desired data variable name.
 - b. In field (5), enter desired expression.
 - c. In field (6), select:
 - AFTER secondary softkey if you want to set a search start condition for finding specified point.
 - DISABLE secondary softkey to disable (clear) the AFTER settings.
 - d. If you selected AFTER, select secondary softkey to enter desired data variable in field (7).
 - e. If you selected AFTER, enter desired expression in field (8).
9. In the Gradient field, enter gradient expression.

Analyzing Measurement Results Automatic Analysis

Data condition mode specifies a point related to the measurement curve. So, if no measurement data satisfy the specified condition, the nearest measurement point is used.

For the meaning of expression that you can enter in step 6 or 7, see “Expression” in Chapter 7.

To specify a point between two measurement points

Set Interpolate field to ON.

To disable (clear) the settings

Move the pointer to field (1), then select DISABLE secondary softkey. Setup fields disappear.

Example

The following figure shows an example setup to automatically draw a line through the specified point with the specified gradient.

The screenshot shows the 'ANALYSIS SETUP' screen with the following fields and callouts:

- (1) Points to the 'WHERE' field in the line equation.
- (2) Points to the 'G1' field in the gradient equation.
- (3) Points to the 'WHERE' field in the marker setup.
- (4) Points to the 'GRAD' field in the line equation.
- (5) Points to the 'G1' field in the gradient equation.
- (6) Points to the 'DISPLAY SETUP' softkey.
- (7) Points to the 'ANALYSIS' softkey.
- (8) Points to the 'Interpolate' field.

The screen content includes:

```

DISPLAY: ANALYSIS SETUP          93JUL22 11:32AM
*LINE1: GRAD [ ] line on [Y1] at a point [WHERE]
[DGM ] = [MAX(DGM)*0 G1]
[AFTER] [DGM ] = [MAX(DGM)]
Gradient: [G1]
(6) (7) (8)
*LINE2: [ ]
*MARKER: At a point where [ ]
*Interpolate: [OFF]
0 5
[DISPLAY SETUP] [ANALYSIS] [ ] [ ] [ ] [ ] [PREV PAGE] [NEXT PAGE]
    
```

UGT02016

Analyzing Measurement Results
Automatic Analysis

To Draw Tangent to Specified Measurement Point

1. Press Display front-panel key.
2. Confirm that ON is set on the LINE *secondary* softkey on the GRAPH/LIST: GRAPHICS screen.
3. Select ANALYSIS SETUP primary softkey. The DISPLAY: ANALYSIS SETUP screen is displayed.
4. In field (1), select TANGENT secondary softkey.
5. In field (2), select secondary softkey to specify desired axis.
6. In field (3), select secondary softkey to select desired data variable name.
7. In field (4), enter desired expression.
8. In field (5), select:
 - AFTER secondary softkey if you want to set a search start condition for finding specified point.
 - DISABLE secondary softkey to disable (clear) the AFTER settings.
9. If you selected AFTER, select secondary softkey to enter desired data variable in field (6).
10. If you selected AFTER, enter desired expression in field (7).

Data condition mode specifies a point related to the measurement curve. So, if no measurement data satisfy the specified condition, the nearest measurement point is used.

For the meaning of expression that you can enter in step 6 and 9, see “Expression” in Chapter 7.

To specify a point between two measurement points

Set Interpolate field to ON.

To disable (clear) the settings

Move the pointer to field (1), then select DISABLE secondary softkey. Setup fields disappear.

Analyzing Measurement Results
Automatic Analysis

Example

The following figure shows an example setup to automatically draw a tangent line to a specified measurement point.

The screenshot shows the 'ANALYSIS SETUP' screen with the following content and callouts:

- (1) points to the text 'line on [Y1]' in the first line of the setup.
- (2) points to the text 'at a point where' in the first line of the setup.
- (3) points to the text '*LINE: [TANGENT]' in the first line of the setup.
- (4) points to the text '[DGM] = {MAX(DGM)*0.01}' in the second line of the setup.
- (5) points to the text '[AFTER] [DGM] = {MAX(DGM)}' in the third line of the setup.
- (6) points to the text '*LINE2: []' in the fourth line of the setup.
- (7) points to the text '*MARKER: At a point where []' in the fifth line of the setup.

At the bottom of the screen, there is a 'MAX(DGM)' label, a 'DISPLAY SETUP' button, an 'AUTO ANALYSIS' button, and 'PREV PAGE' and 'NEXT PAGE' buttons. The screen number 'UGT02017' is located at the bottom left.

Analyzing Measurement Results
Automatic Analysis

To Draw Regression Line by Specifying Two Points

1. Press Display front-panel key.
2. Confirm that ON is set on the LINE *secondary* softkey on the GRAPH/LIST: GRAPHICS screen.
3. Select ANALYSIS SETUP primary softkey. The DISPLAY: ANALYSIS SETUP screen is displayed.
4. In field (1), select REGRESSION secondary softkey.
5. In field (2), select secondary softkey to specify desired axis.
6. In field (3), select:
 - BY X-Y COORDINATE secondary softkey to specify a point by X-Y coordinate mode. (Go to step 6.)
 - BY DATA CONDITION secondary softkey to specify a point by data condition mode. (Go to step 7.)
7. If you selected BY X-Y COORDINATE secondary softkey:
 - a. In the X field, enter desired expression to specify X coordinate.
 - b. In the Y field, enter desired expression to specify Y coordinate.
 - c. Go to step 8.
8. If you selected BY DATA CONDITION secondary softkey:
 - a. In field (4), select secondary softkey to set desired data variable name.
 - b. In field (5), enter desired expression.
 - c. In field (6), select:
 - AFTER secondary softkey if you want to set a search start condition for finding specified point.
 - DISABLE secondary softkey to disable (clear) the AFTER settings.
 - d. If you selected AFTER, select secondary softkey to enter desired data variable in field (7).
 - e. If you selected AFTER, enter desired expression in field (8).
9. Specify the other point by step 5, then step 6 or 7.

Analyzing Measurement Results Automatic Analysis

Example

The following figure shows an example setup to automatically draw a regression line. The range for the regression calculation is specified by two points. One point is specified by X-Y coordinate mode and other point is specified by data condition mode.

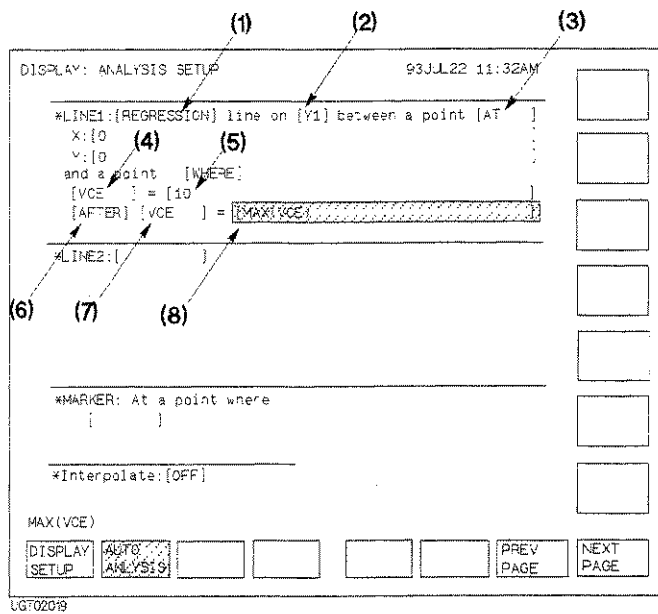

To Display Marker at Specified Point

1. Press Display front-panel key.
2. Select ANALYSIS SETUP primary softkey. The DISPLAY: ANALYSIS SETUP screen is displayed.
3. Move pointer to field (1), then select secondary softkey to set desired data variable name.
4. In field (2), enter desired expression.
5. In field (3), select:
 - AFTER secondary softkey if you want to set a search start condition for finding specified point.
 - DISABLE secondary softkey to disable (clear) the AFTER settings.
6. If you selected AFTER in field (4), select secondary softkey to set desired data variable.
7. If you selected AFTER in field (5), enter desired expression.

The marker can be displayed on the measurement curve only. So, if no measurement data satisfy the specified condition, the nearest measurement point is used.

For the meaning of expression that you can enter in step 4 and 7, see "Expression" in Chapter 7.

To specify a point between two measurement points

Set Interpolate field to ON.

Analyzing Measurement Results Automatic Analysis

Example

The following figure shows an example setup to automatically display marker at specified point.

DISPLAY: ANALYSIS SETUP 93JUL22 11:32AM

*LINE1: [REGRESSION] line on [Y1] between a point [AT]

LINE2: []

(1) (2)

*MARKER: At a point where
[VCE] = [0.]
[AFTER] [VCE] = [MAX(VCE)]

(3) (4) (5)

*Interpolate: [OFF]

MAX(VCE):

DISPLAY	AUTO					PREV	NEXT
SETUP	ANALYSIS					PAGE	PAGE

UGF02020

The screenshot shows the 'ANALYSIS SETUP' menu. Annotations (1) through (5) are as follows:
(1) points to the 'LINE1' field.
(2) points to the 'MARKER' field.
(3) points to the 'Interpolate' field.
(4) points to the first 'VCE' value field.
(5) points to the 'MAX(VCE)' field.

6 Page Organization

Page Organization

This chapter is a reference for operating Agilent 4155B/4156B by using the front-panel controls. The 4155B/4156B is operated by setup pages and results page displayed on the screen. The following sections explain these page structure.

- “Screen Structure”
- “CHANNELS Screen Group”
- “MEASURE Screen Group”
- “DISPLAY Screen Group”
- “GRAPH/LIST Screen Group”
- “STRESS Screen Group”
- “Screen Operation”
- “Status Indicators”

Screen Structure

The 4155B/4156B has seven screen groups that have a total 22 pages as shown in Figure 6-1.

Figure 6-1

Screen Structure of 4155B/4156B

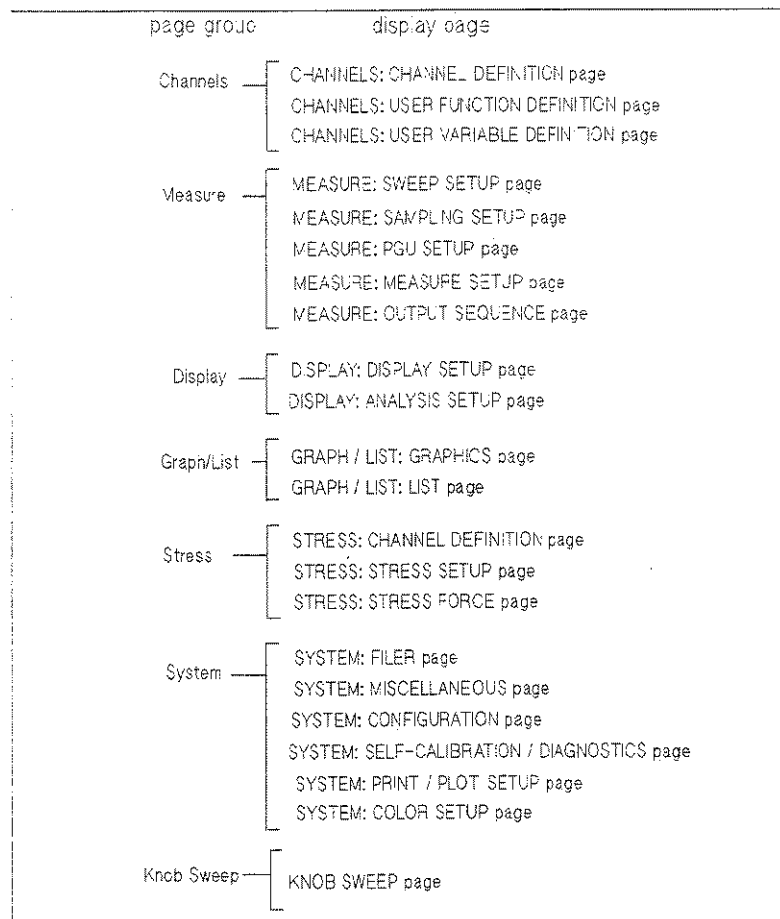

UGD05019 , 110wx125h

Page Organization
Screen Structure

CHANNELS screen group	Defines the measurement modes, measurement channels, and user functions.
MEASURE screen group	Sets the measurement parameters.
DISPLAY screen group	Sets up the display of measurement results.
GRAPH/LIST screen group	Displays the measurement results.
STRESS screen group	Sets and monitors the stress force.
SYSTEM screen group	Controls mass storage, sets system parameters for the 4155B/4156B, sets the print/plot parameters, and so on.
KNOB SWEEP screen group	Displays the measurement results when the knob sweep function is used.

You can use the front-panel keys in the PAGE CONTROL key group to display the desired screen. The PAGE CONTROL key group has the following keys:

Chan	Displays the CHANNELS screen group.
Meas	Displays the MEASURE screen group.
Disp	Displays the DISPLAY screen group.
Graph/List	Displays the GRAPH/LIST screen group.
Stress	Displays the STRESS screen group.
System	Displays the SYSTEM screen group.

For details about the System screen Group, refer to "System Page Organization" in *User's Guide General Information*.

To display the KNOB SWEEP screen, press:

1. the front-panel green key
2. Single key

For details about the KNOB SWEEP screen, see "KNOB SWEEP page" in Chapter 3.

CHANNELS Screen Group

CHANNELS screen group has the following screens:

- Channel Definition: For defining the measurement mode and measurement channels of the 4155B/4156B.
- User Function Definition: For defining the user functions.
- User Variable Definition: For defining the user variables.

To move to the CHANNELS screen group, do one of the following:

- Press Chan front-panel key in the PAGE CONTROL key group.
- Select PREV PAGE primary softkey in the MEASURE: SWEEP SETUP or MEASURE: SAMPLING SETUP screen.

Then, the following primary softkeys appear:

CHANNEL	USER	USER			PREV	NEXT
DEF	FCTN	VAR			PAGE	PAGE

- Select CHANNEL DEF softkey to move to CHANNELS: CHANNEL DEFINITION screen.
- Select USER FCTN softkey to move to CHANNELS: USER FUNCTION DEFINITION screen.
- Select USER VAR softkey to move to CHANNELS: USER VARIABLE DEFINITION screen.

CHANNELS: CHANNEL DEFINITION screen

user comment →

CHANNELS: CHANNEL DEFINITION 94JAN01 01:30PM
Vce - Ic (device 1)

*MEASUREMENT MODE
SWEEP

*CHANNELS					
UNIT	VNAME	INAME	MODE	FCTN	STBY
SMU1: MP	Vb	Ib	I	VAR2	
SMU2: MP	Vce	Ic	V	VAR1	
SMU3: MP			COMMON	CONST	
SMU4: MP					
SMU5: MP					
SMU6: MP					
VSU1					
VSU2					
VMU1					
VMU2					
PGU1					
PGU2					
GNDU					

SERIES RESISTANCE
0 ohm
0 ohm

CONST
VAR1
VAR2
VAR1'
DELETE ROW

VAR1

CHANNELS DEF USER FCTN USER VAR

0306000, 01-02

On the "CHANNELS: CHANNEL DEFINITION" screen, you define the measurement mode and how to use each channel.

User Comment

In this field, you can enter a desired comment. The comment you enter here is also displayed in the CHANNELS, MEASURE, DISPLAY, and GRAPH/LIST screen groups.

MEASUREMENT MODE

MEASUREMENT MODE field sets measurement mode to sweep measurement mode or sampling measurement mode. In this field, select:

- SWEEP secondary softkey to set sweep measurement.
- SAMPLING secondary softkey to set sampling measurement.

To change settings (except for system screen group) to default initial settings, select DEFAULT MEASURE SETUP secondary softkey.

NOTE

Application setup data in internal memories

MEM secondary softkeys indicate that setup or measurement result data is in the internal memory. When you turn on the 4155B/4156B without a diskette or network disk, the following secondary softkeys are displayed:

MEM1 M

B-Tr VCE-IC measurement setup data for bipolar transistor Vce-Ic characteristics.

MEM2 M

FET VDS-ID measurement setup data for FET (field effect transistor) Vds-Id characteristics.

MEM3 M

FET VGS-ID measurement setup data for FET (field effect transistor) Vgs-Id characteristics.

MEM4 M

DIODE VF-IF measurement setup data for diode Vf-If characteristics.

M on the softkey means measurement setup data.

Select softkey to get the desired application measurement setup data. This eliminates the time required to set the setup screens.

See "Initial Settings" in *User's Guide General Information*.

Page Organization
CHANNELS Screen Group

CHANNELS

UNIT.

This column lists all the units that are installed in the 4155B/4156B.

VNAME.

VNAME field assigns a variable name for voltage that will be forced or measured. You can use this name as a reference on the other screens. If channel does neither V force nor V measurement, you can omit VNAME.

In this field, you can do the following:

- Enter a name by using the keyboard or front panel keys
- Select DELETE ROW softkey to delete the VNAME, INAME, MODE, FCTN, and STBY entries for the unit. Unit is disabled.

Restrictions:

- VNAME must be 6 or less alphanumeric characters. First character must be alphabet character.
- Name must be different from other names.

NOTE

Switching units

To switch the VNAME, INAME, MODE, FCTN, and STBY assignment for units, do as follows:

1. Position pointer in top field of VNAME column. CHANNEL ASSIGN secondary softkey appears.
2. Select CHANNEL ASSIGN softkey. Pointer moves to the top field of UNIT column.
3. Use arrow keys in the MARKER/CURSOR key group to move pointer to desired row.
4. Select the secondary softkey of the desired unit. The selected unit appears at the pointer.

Perform steps 3 and 4 until you assign units as desired. Make sure that the same unit is not assigned to multiple rows. Then, select the EXIT CHANNEL ASSIGN softkey.

INAME.

INAME field assigns a variable name for current that will be forced or measured. You can use this name as a reference on the other screens. If channel does neither I force nor I measurement, you can omit INAME.

In this field, you can do the following:

- Enter a name by using the keyboard or front panel keys
- Select DELETE ROW softkey to delete the VNAME, INAME, MODE, FCTN, and STBY entries for the unit. Unit is disabled.

Restrictions:

- INAME must be 6 or less alphanumeric characters. First character must be alphabet character.
- Name must be different from other names.

MODE.

You define an output mode for SMUs, VSUs, PGUs, and GNDU, and measurement mode for VMUs. When the pointer is located in this column, allowable modes appear in the secondary softkey area. You select a softkey to set a mode. The following table shows allowable modes for each unit:

	V	I	VPULSE	IPULSE	COMMON	DVOLT
SMU	Yes	Yes	Yes ^a	Yes ^a	Yes	
VSU	Yes					
PGU	Yes		Yes			
GNDU					Yes	
VMU	Yes					Yes

a. Only for sweep measurements, not for sampling.

To delete the VNAME, INAME, MODE, FCTN, and STBY entries for a unit, select the DELETE ROW secondary softkey. Unit is disabled.

Restrictions:

- Only one SMU can be set to VPULSE or IPULSE. That is, you cannot set multiple SMUs to VPULSE or IPULSE, or cannot set one SMU to VPULSE and another SMU to IPULSE.
- For sampling measurement, you cannot set VPULSE or IPULSE for SMUs. You can set VPULSE for PGUs.

Page Organization
CHANNELS Screen Group

- If both PGUs are set to VPULSE, the STBY settings of both PGUs must be same.

FCTN.

This field defines an output function for SMUs, VSUs, PGUs, and GNDU. When the pointer is located in this column, allowable output functions appear in the secondary softkey area. You select a softkey to set an output function.

- SMU or VSU: you can set VAR1, VAR1', VAR2, or CONST.
- PGU or GNDU: you can set CONST.

Restrictions:

- In FCTN column, you *cannot* set multiple VAR1, VAR1', or VAR2. For example, you *cannot* set VAR1 for 2 units.
- If VAR1' is set, you must set VAR1 also.
- If VAR2 is set, you must set VAR1 also.
- The output modes of VAR1 and VAR1' must be same. That is, the MODE setting for both must be set to a voltage mode, or both must be set to a current mode. For example, you can set VAR1 to V and VAR1' to VPULSE.
- You *cannot* set VAR1, VAR1', or VAR2 for sampling measurement. You can set CONST only.

STBY.

STBY field specifies which channels output source values in the standby state.

- If STBY is set to ON, the unit forces a specified output value when in the standby state.
- If STBY is blank, the unit outputs 0 V in the standby state (same as when in idle state).

See “Types of Operation State” in Chapter 3 for more information on the standby state.

Restrictions:

- If both PGUs are set to VPULSE, the STBY setting of both PGUs must be the same.
- For STBY=ON channel, SERIES RESISTANCE setting must be 0 ohm.

SERIES RESISTANCE.

In the SERIES RESISTANCE fields, you select the value that you want to set in Agilent 16441A R-Box. When the pointer is located in this field, allowable resistance values are shown in the secondary softkey area. You select the desired series resistance.

Normally, SMU1 and SMU2 have SERIES RESISTANCE fields. However, if the SMU and Pulse Generator Expander is installed and if the expander has an HPSMU, then SMU1 and SMU5 have SERIES RESISTANCE fields.

If the 16441A R-box is *not* installed, you must set 0 Ω in this field.

Restrictions:

- To use Kelvin connection for HRSMU or HPSMU, you must select 0 Ω .
- For STBY channels, you can set 0 Ω only.
- For COMMON channels, you can set 0 Ω only.

CHANNELS: USER FUNCTION DEFINITION screen

user comment →

CHANNELS: USER FUNCTION DEFINITION 94JAN01 01:30PM

Vce - Io

NAME	UNIT	DEFINITION
HFE		IC/IB

VE

VB

VCE

IE

IB

IC

TC/IB

CHANNEL DEF USER FCUN USER VAR

PREV PAGE NEXT PAGE

VSD05002, 80x50h

On this screen, you define user functions. For details about user functions, refer to “User Function” in Chapter 7.

User Comment

In this field, you can enter a desired comment, which is also displayed in the CHANNELS, MEASURE, DISPLAY, and GRAPH/LIST screen groups.

NAME

NAME field defines the user function name. In this field, you can enter a name by using the keyboard or front panel keys. Or you can select variables that are shown on the secondary softkeys.

To delete a user function, you can select DELETE ROW softkey to delete the NAME, UNIT, and DEFINITION entries.

After defining a user function, you can use this variable name for reference on other screens.

Restrictions

- NAME must be 6 or less alphanumeric characters. First character must be alphabet character.
- NAME must be different from other names. The alphabet characters are case sensitive. For example, HFE is different from Hfe.

UNIT (optional)

UNIT defines the unit of the user function. This unit is used on the graph and list result screens.

Restriction: UNIT must be 6 or less alphanumeric characters.

To delete a user function, you can select DELETE ROW softkey to delete the NAME, UNIT, and DEFINITION entries.

DEFINITION

You enter an expression that defines the user function. The expression can consist of numerical operators, constants, variables, built-in functions, and other user-defined functions.

By selecting secondary softkeys, you can enter VNAMES or INAMES that are set on the CHANNELS: CHANNEL DEFINITION screen.

For syntax, see “Expression” in Chapter 7. For example, to define a user function for mutual conductance *gm* of an FET, define *gm* on this screen as follows:

CHANNELS: USER FUNCTION DEFINITION 94JAN01 01:30PM

NAME	UNIT	DEFINITION
GM		DIFF(ID,VS)

VS
VDS
VG
VSUB
IS
ID
MORE
1/2

DIFF (ID/VG)

CHANNEL DEF USER FCTN USER VAR

PREV PAGE NEXT PAGE

UG005020, 100x70

CHANNELS: USER VARIABLE DEFINITION screen

On this screen, you register user variables that were defined by GPIB. To use a user variable, you must register it on this screen. For details about user variables, refer to “User Variable” in Chapter 7.

CHANNELS: USER VARIABLE DEFINITION 94JAN01 01:30PM

user comment → Vce - Ic

#USER VARIABLE		
NAME	UNIT	SIZE
Vth	V	100

100

DELETE ROW

CHANNEL DEF USER FCN USER VAR PREV PAGE NEXT PAGE

UGD05028, 80x50h

User Comment

In this field, you can enter a desired comment, which is also displayed in the CHANNELS, MEASURE, DISPLAY, and GRAPH/LIST screen groups.

NAME

NAME field defines the user variable name. You can enter a name by using the keyboard or front-panel keys.

To delete a user variable, select DELETE ROW softkey to delete the NAME, UNIT, and SIZE entries.

After defining a user variable, you can use this variable name for reference on other screens.

Restrictions

- NAME must be 6 or less alphanumeric characters. First character must be alphabet character.
- NAME must be different from other names. The alphabet characters are case sensitive. For example, HFE is different from Hfe.

UNIT (optional)

UNIT defines the unit of the user variable. This unit is used on the graph and list result screens. You can enter the unit by using the keyboard or front-panel keys.

To delete a user variable, select DELETE ROW softkey to delete the NAME, UNIT, and SIZE entries.

Restriction: UNIT must be 6 or less alphanumeric characters.

SIZE

SIZE field sets the number of data for the user variable. The number of data must be 10001 or less (total for all measurement data and user variables). You can enter the size by using the keyboard or front-panel keys.

To delete a user variable, select DELETE ROW softkey to delete the NAME, UNIT, and SIZE entries.

MEASURE Screen Group

MEASURE screen group has the following screens:

Sweep Setup or

Sampling Setup: For setting the parameters for sweep or sampling measurement, which was defined in the CHANNELS: CHANNEL DEFINITION screen.

PGU Setup: For setting the PGU parameters. This screen is available when PGU is installed and the MODE and FCTN field of PGUs are set on the CHANNELS: CHANNEL DEFINITION screen.

Measure Setup: For setting the measurement range, integration time, zero cancel, and wait time.

Output Sequence: For setting the output sequence and triggering.

To move into the MEASURE screen group, do one of the following:

- Press Meas front-panel key in the PAGE CONTROL key group.
- Select NEXT PAGE primary softkey in the CHANNELS: USER FUNCTION DEFINITION screen.
- Select PREV PAGE primary softkey in the DISPLAY: DISPLAY SETUP screen.

Then, the following primary softkeys appear:

SWEEP	PGU	MEASURE	OUTPUT		PREV	NEXT
SETUP	SETUP	SETUP	SEQ		PAGE	PAGE

- Select SWEEP SETUP softkey to move to MEASURE: SWEEP SETUP screen.
- Select SAMPLNG SETUP softkey to move to MEASURE: SAMPLING SETUP screen.
- Select PGU SETUP softkey to move to MEASURE: PGU SETUP screen.
- Select MEASURE SETUP softkey to move to MEASURE: MEASURE SETUP screen.
- Select OUTPUT SEQ softkey to move to MEASURE: OUTPUT SEQUENCE screen.

MEASURE: SWEEP SETUP screen

MEASURE: MEASURE SETUP 94JAN01 01:30PM

device1 (anneal 1)

user comment →

*MEASUREMENT RANGE				ZERO	CANCEL	ON
UNIT	NAME	RANGE				
SMU1:HR	IA	AUTO	2.0	ON		
SMU2:HR	IB	LIMITED	100pA	ON		FIXED
SMU3:HR	IC	FIX	1nA	ON		
SMU4:HR	VA	AUTO		OFF		
SMU5:MP	VB	AUTO		OFF		
SMU6:MP	VC	AUTO		OFF		LIMITED
VMU1	DVOLT	AUTO		OFF		AUTO
VMU2				OFF		

*INTEG TIME

	TIME	NPLC
@SHORT	80us	0.004
MED	20ms	1
LONG	2000ms	100

(@ Selected Integ. Time)

*WAIT TIME

1.0 × (Default Wait Time)

AUTO

UGD05006, 100x50

On this screen, you set output parameters for each unit.

User Comment

In this field, you can enter a desired comment, which is also displayed in the CHANNELS, MEASURE, DISPLAY, and GRAPH/LIST screen groups.

VAR1 parameters

In this column, you set up output parameters for primary sweep unit. UNIT and NAME are defined on CHANNELS: CHANNEL DEFINITION screen.

- SWEEP MODE
 - SWEEP MODE field sets **single** or **double sweep mode**. In this field, select:
 - SINGLE secondary softkey to specify the single sweep mode.
 - DOUBLE secondary softkey to specify the double sweep mode.

Page Organization
MEASURE Screen Group

- LIN/LOG

LIN/LOG field sets **linear** or **logarithmic sweep mode**. In this field, select:

- LINEAR secondary softkey to set linear sweep mode.
- LOG10, LOG25, or LOG50 secondary softkey to set logarithmic sweep mode. The number specifies the sweep points per decade.

- START, STOP, and STEP

In the START, STOP, and STEP fields, you specify the **start, stop, and step values**. The step value is used for the linear sweep mode *only*.

The following applies to logarithmic sweep mode only:

- STEP field has no meaning, so "-----" is shown in the STEP field.
- Start and stop values must be the same polarity.
- If you specify 0 (zero) for the start or stop value, the minimum output value for the unit is used.
- You specify the number of steps per decade in the LIN/LOG field.

- NO. OF STEP

For the linear sweep mode, the number of steps is calculated from the start, stop, and step values, and appears in the NO. OF STEP field.

For the logarithmic sweep mode, the number of steps is calculated from the start, stop, and LIN/LOG values, and appears in the NO. OF STEP field.

- COMPLIANCE

In the COMPLIANCE field, you set the **compliance value**. If a VSU is used for the VAR1 unit, this field *cannot* be set: compliance value is fixed to 100 mA.

- POWER COMP

In the POWER COMP field, you can set a **power compliance value** for SMUs. To disable the power compliance function, select the OFF secondary softkey. If *an* SMU is set to VPULSE or IPULSE mode and if the SMU is set to VAR1, you *cannot* set power compliance for the VAR1 SMU.

VAR2 parameters

In this column, you set up the output parameters for the secondary sweep unit. UNIT and NAME are defined on the CHANNELS: CHANNEL DEFINITION screen.

SWEEP MODE and LIN/LOG fields are fixed to SINGLE and LINEAR.

- START, STEP, and NO. OF STEP

In the START, STEP, and NO OF STEP fields, you specify the start value, step value, and number of steps. The stop value is calculated from these values, and is shown in the STOP field.

- COMPLIANCE

In COMPLIANCE field, you set compliance value. If a VSU is used for VAR2 unit, this field *cannot* be set: compliance value is fixed to approximately 100 mA.

- POWER COMP

In POWER COMP field, you can set power compliance value for SMUs. To disable power compliance function, select OFF secondary softkey.

VAR1' parameters

In this column, you set up the output parameters for the synchronous sweep unit. This VAR1' table is displayed only when VAR1' is set in the FCTN field on the CHANNELS: CHANNEL DEFINITION screen.

UNIT and NAME are defined on CHANNELS: CHANNEL DEFINITION screen.

- OFFSET and RATIO

In the OFFSET and RATIO fields, you specify the *offset* and *ratio* values. The offset and ratio values determine the VAR1' value as follows:

$$\text{VAR1' output} = \text{VAR1 output} \times \text{ratio} + \text{offset}$$

- COMPLIANCE

In COMPLIANCE field, you set compliance value. If a VSU is used for VAR1' unit, this field *cannot* be set: compliance value is fixed to 100 mA.

- POWER COMP

In the POWER COMP field, you can set the power compliance value. To disable the power compliance function, select OFF secondary softkey. If *an* SMU is set to VPULSE or IPULSE mode and if the SMU is set to VAR1', you *cannot* set power compliance for the VAR1' SMU.

TIMING

- HOLD TIME

In the HOLD TIME field, you set the **hold time**. The output unit waits this time after forcing the start value. Range: 0 to 655.35 s. Resolution: 10 ms.

- DELAY TIME In DELAY TIME field, you set the **delay time**. The output unit waits this time after each step, then starts measurement. If an SMU is set up to be a pulse source, DELAY TIME field is not displayed because each step is synchronized with pulse output. Range: 0 to 65.535s. Resolution: 100 μ s.

SWEEP Status

- Select CONT AT ANY secondary softkey (sweep will continue even if an abnormal status occurs). Abnormal status means the following:
 - SMU reaches its compliance setting.
 - Current of VSU exceeds approximately ± 100 mA.
 - SMU or VSU oscillates.
 - A/D converter overflow occurs.
 - Average current of PGU exceeds ± 100 mA.
- Select STOP AT ANY ABNORM secondary softkey (sweep will stop if any abnormal status occurs).
- Select STOP AT COMPLIANCE secondary softkey (sweep will stop only if SMU reaches its compliance setting).

STOP AT COMPLIANCE is automatically set when power compliance is set for SMUs, or when 10k ohm, 100k ohm, or 1M ohm is selected in the SERIES RESISTANCE field. If power compliance is set for an SMU, the CONT AT ANY secondary softkey is not displayed.

SMU PULSE

These parameters set the SMU pulsed source (IPULSE or VPULSE). The SMU pulsed source is defined on the CHANNELS: CHANNEL DEFINITION screen, so the UNIT and NAME fields are already set.

In the PERIOD, WIDTH, and BASE fields, you specify the pulse period, pulse width, and pulse base value. The pulse peak value is determined by the settings in the VAR1, VAR2, VAR1', or CONSTANT field.

Be aware that if any of following are true, pulsed SMU channel may not output the pulse period and pulse width you specified:

- Measurement range differs from compliance range (lowest range that includes compliance).
- Ranging mode is set to auto range or limited auto range.
- Multi-channel measurement is set.

CONSTANT

These parameters set the constant source units. UNIT, NAME, and MODE are defined on the CHANNELS: CHANNEL DEFINITION screen.

- SOURCE

In the SOURCE field, you specify the output value.

- COMPLIANCE

In this field, you set compliance value. If VSU is used for constant output unit, this field cannot be set: compliance value is fixed to 100 mA.

If you define more than four constant output units, the first four units appear in the CONSTANT fields. To show other units, select NEXT UNIT secondary softkey. To scroll the units, put field pointer in most right or left column, then press the right arrow or left arrow MARKER/CURSOR front-panel key.

MEASURE: SAMPLING SETUP screen

MEASURE: SAMPLING SETUP 94.JAN01 01:30PM

Vce - Ic

User comment →

#SAMPLING PARAMETER		#STOP CONDITION	
MODE	LINEAR	ENABLE/DISABLE	ENABLE
INITIAL INTERVAL	1 ms	ENABLE DELAY	0.01 s
NO. OF SAMPLES	1001	NAME	R
TOTAL SAMP. TIME	AUTO	THRESHOLD	0.1
		EVENT	Val > Th
HOLD TIME	0.000 s	EVENT NO.	2
FILTER	ON		

#CONSTANT				
UNIT				
NAME				
MODE				
SOURCE				
COMPLIANCE				

1

UGD05004, 100x50

On this screen, you set sampling parameters for each unit. For details, see “Sampling Measurement Mode” in Chapter 2.

User Comment

In this field, you can enter a desired comment, which is also displayed in the CHANNELS, MEASURE, DISPLAY, and GRAPH/LIST screen groups.

SAMPLING PARAMETER

- **MODE**

MODE field sets the **sampling mode**. In this field, select:

- LINEAR secondary softkey to specify the linear sampling mode.
- LOG10, LOG25, or LOG50 secondary softkey to specify the logarithmic sampling mode. The number specifies how many samples to take per decade.
- Select THINNED-OUT softkey to specify the thinned-out sampling mode, which discards less recent samples.

- INITIAL INTERVAL

In the INITIAL INTERVAL field, you set the **initial interval** which is the interval of measurement trigger. Not measurement interval. Measurement unit executes measurement if it is ready to measure at the trigger. If the unit is busy or in measurement, the unit waits for the next trigger.

- NO. OF SAMPLES

This field sets the **number of samples**. The number of samples must be 10001 or less (total for all units that make measurements plus size of all registered user variables). The number of units that make measurements is determined by the DISPLAY: DISPLAY SETUP screen.

- TOTAL SAMP. TIME (for linear and thinned-out sampling mode)

TOTAL SAMP. TIME field sets the **total sampling time**. The total sampling time must satisfy the following condition:

$$\text{total sampling time} \geq \text{initial interval} \times (\text{number of samples} - 1)$$

In this field, enter a value or select:

- NO LIMIT secondary softkey to continue the sampling until sampling completion condition is satisfied. For linear sampling mode, **initial interval** must be more than 480 μ s.
- (for linear sampling mode only) AUTO secondary softkey to set the total sampling time to *initial interval* \times (*number of samples* - 1).
- HOLD TIME
HOLD TIME field sets the **hold time**. The unit waits this time after forcing the specified constant value, then sampling starts.
Range: (for *initial interval* < 2 ms) -30ms to 655.35s with 100 μ s resolution.
(for *initial interval* \geq 2 ms) 0 to 655.35s with 100 μ s resolution.
- FILTER This field specifies SMU filter to ON or OFF. If this field is set to ON, overshoot is decreased, but settling time takes several ms. Be aware of this if you set initial interval to a short time.

STOP CONDITION

- ENABLE/DISABLE

This field defines whether the **stop conditions** are enabled. Cannot ENABLE if INITIAL INTERVAL < 2 ms. In this field, select:

- ENABLE secondary softkey to enable the stop conditions.
- DISABLE secondary softkey to disable the stop conditions.

- ENABLE DELAY

This field sets the **enable delay** time. The stop condition is ignored for the enable delay time after the sampling starts. The resolution of enable delay time is the initial interval time.

- NAME

NAME field sets the variable name or user function name that you want to monitor for the stop conditions. Allowable variable names and user function names are shown in the secondary softkey area.

- THRESHOLD

In the THRESHOLD field, you set the **threshold value**.

- EVENT

In the EVENT field, you set the event type as follows:

Val>Th event occurs when NAME value is greater than THRESHOLD.

Val<Th event occurs when NAME value is less than THRESHOLD.

|Val|>|Th| event occurs when absolute NAME value is greater than absolute THRESHOLD value.

|Val|<|Th| event occurs when absolute NAME value is less than absolute THRESHOLD value.

- EVENT NO.

EVENT NO. specifies sampling to stop if event occurs EVENT NO. times. EVENT NO. can be an integer from 1 to 200.

CONSTANT

This is for setting the output parameters of the constant source units. UNIT, NAME, and MODE are defined on the CHANNELS: CHANNEL DEFINITION screen.

- **SOURCE**

In the SOURCE field, you specify the output value.

- **COMPLIANCE**

In the COMPLIANCE field, you specify the compliance value. If a VSU is used for the constant output unit, this field cannot be set: compliance value is fixed to 100 mA.

If you define more than four constant output units, first four units appear in CONSTANT fields. To show other units, select NEXT UNIT secondary softkey. To scroll units, put field pointer in most right or left column, then press the right arrow or left arrow MARKER/CURSORS front-panel key.

MEASURE: PGU SETUP screen

MEASURE: PGU SETUP 94JAN01 01:30PM

user comment → Vee - Ic

#PULSE		
UNIT	PGU1	PGU2
NAME		
PERIOD	10.00ms	
WIDTH	5.00ms	
DELAY TIME	0.00000 s	
PEAK VALUE	1.00mV	
BASE VALUE	0.00 V	
LEADING TIME	100ns	
TRAILING TIME	100ns	
IMPEDANCE	LOW	
PULSE COUNT	0	

#CONSTANT		
UNIT	PGU1	PGU2
NAME		
SOURCE		

0.00500

SWEEP SETUP PGU SETUP MEASURE SETUP OUTPUT SEQ PREV PAGE NEXT PAGE

UGD05005, 100x60

On the "MEASURE: PGU SETUP" screen, you set output parameters for each PGU. For more information about PGUs, see "Pulse Generator Unit (PGU)" in Chapter 1.

User Comment

In this field, you can enter a desired comment. The comment you enter here is also displayed in the CHANNELS, MEASURE, DISPLAY, and GRAPH/LIST screen groups.

PULSE

You set the pulse output parameters in the PULSE area.

UNIT and NAME are defined on the CHANNELS: CHANNEL DEFINITION screen.

- PERIOD

PERIOD field specifies the pulse period of the PGU. Note that the pulse period of PGUs is independent from that of the SMUs.

- WIDTH

WIDTH field specifies the pulse width. The pulse width must be less than the pulse period.

- **DELAY TIME**

DELAY TIME field specifies the delay time from the pulse period start time. The delay time must be less than or equal to the pulse period.

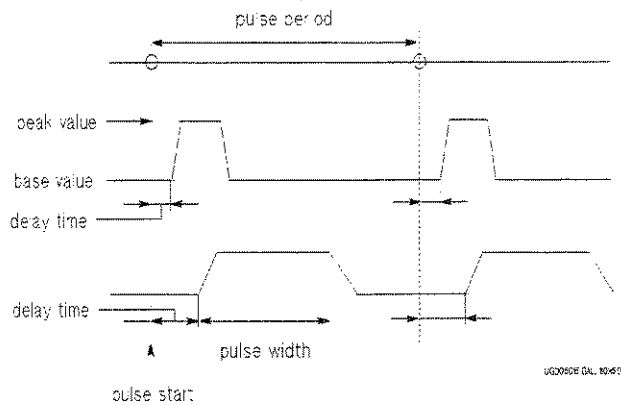

- **PEAK VALUE and BASE VALUE**

PEAK VALUE and **BASE VALUE** fields specify the pulse peak and pulse base values.

- **LEADING TIME and TRAILING TIME**

LEADING TIME and **TRAILING TIME** fields specify the transition time of leading and trailing edges, which is time for pulse to change from 10% to 90% of pulse amplitude.

- **IMPEDANCE**

IMPEDANCE field specifies the PGU output impedance. In this field, select:

- **LOW** secondary softkey to set output impedance to about 0 Ω
- **50 ohm** secondary softkey to set output impedance to 50 Ω

Page Organization
MEASURE Screen Group

- PULSE COUNT

PULSE COUNT field specifies the number of pulses for the sampling measurement (for sweep measurements, only FREE RUN is available).

- Enter a pulse count value (only for sampling measurements).
- Select FREE RUN or enter 0 (zero) to set continuous pulse output. If either PGU1, PGU2, or both are set to standby ON on the CHANNELS: CHANNEL DEFINITION screen, this field is automatically set to *free run* mode.

CONSTANT

UNIT and NAME are defined on CHANNELS: CHANNEL DEFINITION screen.

In the SOURCE field, you specify the output value.

MEASURE: MEASURE SETUP screen

MEASURE: MEASURE SETUP 94 JAN 01 01:30 PM
device1 (anneal 1)

user comment →

*MEASUREMENT RANGE				ZERO	CANCEL	ON
UNIT	NAME	RANGE				
SMU1:HR	IA	AUTO		ON		
SMU2:HR	IB	LIMITED	100pA	ON		
SMU3:HR	IC	FIX	1nA	ON		
SMU4:HR	VA	AUTO		OFF		
SMU5:MP	VB	AUTO		OFF		
SMU6:MP	VC	AUTO		OFF		
VMU1	DVOLT	AUTO		OFF		
VMU2				OFF		

*INTEG TIME

	TIME	NPLC
@SHORT	80us	0.004
MED	20ms	1
LONG	2000ms	100

(@ Selected Integ. Time)

*WAIT TIME

1.0 x (Default Wait Time)

AUTO

UG005006, 00x50

On the "MEASURE: MEASURE SETUP" screen, you set measurement range, zero cancel, integration time, and wait time.

User Comment

In this field, you can enter a desired comment. The comment you enter here is also displayed in the CHANNELS, MEASURE, DISPLAY, and GRAPH/LIST screen groups.

MEASUREMENT RANGE

You can set the measurement range for each unit.

- UNIT

The UNIT field shows all the installed measurement units. Only measurement units are shown, so VSU, PGU, and GNDU are not shown.

- NAME

The NAME field shows all names for the measurement units, which you defined on the CHANNELS: CHANNEL DEFINITION screen. For example, when the SMU1 is set to V mode, current value is measured. So the current name (INAME) is shown in the NAME field.

- RANGE

The left field of RANGE specifies the **ranging mode**. In this field, select:

- AUTO secondary softkey to set **auto-ranging mode**.
- FIXED secondary softkey to set **fixed-ranging mode**.
- LIMITED AUTO secondary softkey to set **limited auto-ranging mode**.

The right field of RANGE specifies the **range value**. For auto-ranging mode, "-----" appears. For the fixed-ranging and limited auto-ranging modes, allowable range values are shown in the secondary softkey area. You select a softkey to set the range value.

For details, see "Measurement Range Mode" in Chapter 3.

- ZERO CANCEL

ZERO CANCEL field specifies **zero offset cancel mode**. Select ZERO CANCEL ON/OFF to toggle the zero offset cancel mode between on and off.

If the zero offset cancel mode is set to OFF, then OFF appears in all the ZERO CANCEL fields. If zero offset cancel mode is set to ON, then ON or OFF appear automatically in each field depending on the measurement range.

For details, see "Zero Offset Cancel" in Chapter 3.

INTEG TIME

INTEG TIME area shows integration time and corresponding number of power line cycles (NPLC) for short, medium, and long modes. You can change integration time for short and long modes, but not for medium mode.

The selected integration time is indicated by @, and is used for all measurement units. You select the integration time by using the Short, Medium, or Long front panel keys from any screen.

- SHORT

The TIME field for SHORT shows the integration time of the short mode. You can change this integration time. NPLC value is calculated from the integration time and power line frequency.

- MED

The TIME field for MED shows the integration time of the medium mode, which is calculated from the power line frequency and NPLC value. NPLC value is always 1. You cannot change it.

- LONG

The TIME field for LONG shows the integration time of the long mode, which is calculated from the NPLC and power line frequency. You can change the NPLC value.

For details, see “Integration Time” in Chapter 3.

WAIT TIME

For each unit, the 4155B/4156B automatically uses a wait time that depends on the range value. This is the default wait time. In the WAIT TIME field, the value you specify is multiplied times the default wait time. Allowed values are 0.0 to 10.0 with 0.1 step.

The wait time is the time that a unit waits after forcing a value. During the wait time, the unit cannot start the measurement.

The default wait time is recommended. It is not easy to determine the best wait time. If you specify a wait time that is too short, the measurement may start before the output is stable. If too long, time will be wasted.

MEASURE: OUTPUT SEQUENCE screen

MEASURE: OUTPUT SEQUENCE 94JAN01 01:30PM
device 1 (channel length 1)

user comment →

*OUTPUT SEQUENCE			*TRIGGER SETUP	
UNIT	NAME	MODE	ENABLE/DISABLE	DISABLE
1: SMU1:HR	IA	I	FUNCTION	TRIG OUT
2: SMU2:HR	IB	I	STEP DELAY	0.00
3: SMU3:HR	IC	I	POLARITY	POSITIVE
4: SMU4:HR				
5: SMU5:MP				
6: SMU6:MP				
7: VSU1				
8: VSU2				
9: PGU1		VPLS		
10: PGU2		VPLS		

*OUTPUT SEQUENCE MODE
OF SAMPLING
SEQUENTIAL

POSITIVE

SWEEP SETUP PGU SETUP MEASURE SETUP OUTPUT SEQ. PREV PAGE NEXT PAGE

UGD05007, 100x60

On this screen, you set the output sequence and triggering parameters for measurement state.

The output sequence set on this screen is also used when the state changes from idle state to stress force state.

For trigger setup for stress force state, see “Stress Output Channels” in Chapter 3.

User Comment

In this field, you can enter a desired comment, which is also displayed in the CHANNELS, MEASURE, DISPLAY, and GRAPH/LIST screen groups.

OUTPUT SEQUENCE

In the UNIT column, allowable units are shown in output sequence order. Only output units are shown, so VMU and GNDU are not shown. In the NAME and MODE fields, the output names and mode that you set up on the CHANNELS: CHANNEL DEFINITION screen are shown.

To change the output order of the units, enter unit names in desired order by selecting secondary softkeys.

For details about default sequence, see “Sequential Mode” in Chapter 3.

OUTPUT SEQUENCE MODE OF SAMPLING

For a sampling measurement, you can set the output sequence to **sequential mode** or **simultaneous mode**. This field is displayed only when sampling mode is selected on the CHANNELS: CHANNEL DEFINITION screen. If you select sequential mode, OUTPUT SEQUENCE table determines the output order. If you select simultaneous mode, all the units force at the same time.

TRIGGER SETUP

- **ENABLE/DISABLE**

ENABLE/DISABLE field defines whether the triggering function is used or not. In this field, select:

- ENABLE secondary softkey to enable the triggering function.
- DISABLE secondary softkey to disable the triggering function.

- **FUNCTION**

FUNCTION field sets the triggering mode.

- Select TRIG OUT secondary softkey to enable the following functions:
 - For a normal (non-pulse) sweep measurement, the 4155B/4156B outputs an edge-trigger signal when a measurement starts for each step.
 - For a pulsed sweep measurement, the 4155B/4156B outputs an edge-trigger signal synchronized with the pulse leading edge.
- Select TRIG IN to enable the following function:
 - Sweep measurement or sampling measurement starts when the 4155B/4156B receives a trigger signal from an external instrument.

- **STEP DELAY**

STEP DELAY field is displayed when you set staircase sweep measurement. The step delay time is the time from when the trigger is output to when the next step occurs. For details about setup delay time, refer to "Triggering an External Instrument" in Chapter 3. When you set TRIG IN in the FUNCTION field, this field has no meaning, so "-----" is displayed.

Page Organization
MEASURE Screen Group

- TRIG OUT DELAY

TRIG OUT DELAY field is displayed when you set pulse sweep measurement. The trigger output delay time specifies how much to delay the trigger after the leading edge. For details about trigger output delay time, refer to “Triggering an External Instrument” in Chapter 3. When you set TRIG IN in the FUNCTION field, this field has no meaning, so “-----” is displayed.

- POLARITY

In the POLARITY field, select secondary softkeys to select trigger polarity as follows: POSITIVE or NEGATIVE.

DISPLAY Screen Group

DISPLAY screen group has the following screens:

- Display Setup: For setting the graphics/list display mode, the parameters for graphics/list screen, and measurement channels.
- Analysis Setup: For defining where to automatically display lines and marker after a measurement.

To move into the DISPLAY screen group, do one of the following:

- Press Display front-panel key in the PAGE CONTROL key group.
- Select NEXT PAGE primary softkey in the MEASURE: OUTPUT SEQUENCE screen.

Then, the following primary softkeys appear:

<u>DISPLAY</u>	<u>ANALYSIS</u>	_____	_____	_____	_____	<u>PREV</u>	<u>NEXT</u>
<u>SETUP</u>	<u>SETUP</u>	_____	_____	_____	_____	<u>PAGE</u>	<u>PAGE</u>

- Select DISPLAY SETUP softkey to move to the DISPLAY: DISPLAY SETUP screen.
- Select ANALYSIS SETUP softkey to move to DISPLAY: ANALYSIS SETUP screen.

NOTE

Execution Timing of the Automatic Analysis Function

You set up automatic analysis on the DISPLAY : ANALYSIS SETUP screen.

Automatic analysis function is executed:

- after a measurement is executed by Single or Append front-panel key.
- when the Stop front-panel key is pressed to stop the measurement.
- after each measurement execution (before the next measurement execution).
- when you select the AUTO ANALYSIS secondary softkey after selecting the MARKER/CURSOR primary softkey on the GRAPH/LIST: GRAPH or GRAPH/LIST: LIST screen.
- when you return to the GRAPH/LIST: GRAPH or GRAPH/LIST: LIST screen after changing the condition of the automatic analysis function on the DISPLAY: ANALYSIS SETUP screen.

If you define both the automatic marker positioning and automatic line drawing functions, the functions are executed in the following order:

1. Automatic line drawing for LINE1.
2. Automatic line drawing for LINE2.
3. Automatic marker positioning.

Page Organization
DISPLAY Screen Group

- **NAME**

NAME fields specify the variable names that you want to assign to the axes, which will be plotted on the GRAPHICS screen. In this field, you can select the desired variable names in the secondary softkey area.

The entries in these fields and the data variable fields determine which channels will actually make measurements.

- **SCALE**

The SCALE fields specify linear or logarithmic scale for the axis by selecting LINEAR or LOG secondary softkey.

- **MIN and MAX**

MIN and MAX fields specify the minimum and maximum values for the axis. The minimum and maximum values are automatically set according to the NAME and SCALE settings. You can modify these values if desired.

GRID

In the GRID field, you can specify whether to display the grid on the plotting area by selecting ON or OFF secondary softkey.

LINE PARAMETER

In the LINE PARAMETER field, you can specify whether to display X and Y intercepts and gradients of lines on the plotting area by selecting ON or OFF secondary softkey.

OFF The line parameters are not displayed.

ON The line parameters are displayed when lines are displayed on the graph.

DATA VARIABLES

In the DATA VARIABLES fields, you can enter two variable names. The numerical values of these variables will be shown on the GRAPHICS screen according to the marker position. In this field, you can select the desired variable names in the secondary softkey area.

Even if the setup data variables are defined using variables that are not set in the NAME field of the GRAPHICS table, the variables are automatically measured after pressing a measurement front-panel key.

DISPLAY: DISPLAY SETUP screen for list results

user comment → Vce - Ic

DISPLAY: DISPLAY SETUP 94JAN01 01:30PM

#DISPLAY MODE
 LIST

No.	NAME
1	VE
2	IC
3	IB
4	
5	
6	
7	
8	

#DATA VARIABLES

IB

VE
 VC
 VB
 IE
 IC
 IB
 MORE
 1/2

IB
 DISPLAY SETUP AUTO ANALYSIS PREV PAGE NEXT PAGE

UGD05009,100*50

On the "DISPLAY: DISPLAY SETUP" screen for list results, you enter variable names for which you want results to be displayed numerically. The measurement channels are determined by the variable names that you set on this screen.

User Comment

In this field, you can enter a desired comment, which is also displayed in the CHANNELS, MEASURE, DISPLAY, and GRAPH/LIST screen groups.

DISPLAY MODE

This field specifies display mode. If present mode is graphics mode, select LIST softkey to change to list mode. LIST table is displayed.

LIST

NAME fields of LIST area specify variables that you want to display on LIST screen. You can enter the desired variable names. Entries in this area and data variable area determine which channels will actually make measurements. You can enter up to eight variable names. When the pointer is located in NAME field, you can select desired variable names in secondary softkey area.

Page Organization
DISPLAY Screen Group

DATA VARIABLES

DATA VARIABLES fields specify the variable names that you want to display on the GRAPH/LIST: LIST screen. The numerical values of these variables will be shown on the LIST screen according to the marker position. In this field, you can select the desired variable names in the secondary softkey area.

Even if the setup data variables are defined using variables that are not set in the NAME field of the LIST table, the variables are automatically measured after pressing a measurement front-panel key.

DISPLAY: ANALYSIS SETUP screen

user comment →

93.JUL.22 11:32AM

DISPLAY: ANALYSIS SETUP
 device 1 (anneal 1)

#LINE1: [REGRESSION] line on [Y1] between a point [AT]
 X: [0]
 Y: [0]
 and a point [WHERE]
 [VCE] = [10]
 [AFTER] [VCE] = [MAX(VCE)]

#LINE2: [GRAD] line on [Y1] at a point [WHERE]
 [DGM] = [MAX(DGM)*0.01]
 [AFTER] [DGM] = [MAX(DGM)]
 Gradient: [0.5]

#MARKER: At a point where
 [VCE] = [0.1]
 [AFTER] [VCE] = [MAX(VCE)]

*Interpolate: [OFF]

MAX(VCE)

UG005010,100x50

On the "DISPLAY: ANALYSIS SETUP" screen, you set up the automatic analysis function. When a measurement finishes, the function automatically draws lines, a marker, or both as specified on this screen.

You can set up two lines and one marker for the automatic analysis function. In the LINE1 and LINE2 fields, you can set up the lines to be drawn. In the MARKER field, you set up the marker.

For the automatic analysis function and the manual analysis function, four line modes can be used:

- Normal mode: drawing a line between *any two* points.
- Grad mode: drawing a line through *any point* with a specified gradient.
- Tangent mode: drawing a tangent to a *measurement* point.
- Regression mode: drawing a regression line for the area specified by *any two* points.

The following explains how to set up the lines and marker. For details about line modes, refer to "Line Drawing" in Chapter 7.

User Comment

In this field, you can enter a desired comment. This comment is also displayed in the CHANNELS, MEASURE, DISPLAY, and GRAPH/LIST screen groups.

Page Organization
DISPLAY Screen Group

Normal mode line

In the first bracketed field after LINE1 or LINE2, you select the line mode. Select the NORMAL secondary softkey to set the normal line mode. The pointer moves to the second bracketed field as shown:

```
LINE1: [NORMAL ] LINE ON [Y1] between a point [AT ]
```

In the second bracketed field, you specify which measurement curve you want to analyze by selecting the related axis: Y1 or Y2 secondary softkey.

In the third bracketed field, you specify how to select a point:

- Select BY X-Y COORDINATE. "AT" is displayed. Then, you enter the desired X-Y coordinate values or expressions in the X: and Y: fields.
- Select BY DATA CONDITION. "WHERE" is displayed. Then, you enter a variable name and condition expression to specify a measurement point.

```
LINE1: [NORMAL ] LINE ON [Y1] between a point [AT ]  
X: [0 ]  
Y: [0 ]  
and a point [WHERE]  
[DGM ] = [MAX(DGM)*0.01 ]  
[ ]
```

In addition, you can specify another condition if you position the pointer in the last bracketed field shown above. Select the AFTER secondary softkey. AFTER is displayed, and you can enter a second variable and condition expression. This sets up a search start condition for finding specified point. (This setup is optional.)

For example, you can specify the following expressions to search for a measurement point that satisfies the first condition after the second condition is satisfied.

```
LINE1: [NORMAL ] LINE ON [Y1] between a point [AT ]  
X: [0 ]  
Y: [0 ]  
and a point [WHERE]  
[DGM ] = [MAX(DGM)*0.01 ]  
[AFTER] [DGM ] = [MAX(DGM) ]
```

On GRAPH/LIST: GRAPHICS screen, LINE secondary softkey must be ON.

Gradient mode line

In the first bracketed field after LINE1 or LINE2, you select the line mode. Select the GRAD secondary softkey to set the gradient line mode. The pointer moves to the second bracketed field as shown:

```
LINE1: [GRAD      ] LINE ON [Y1] between a point [      ]
```

```
Gradient: [      ]
```

In the second bracketed field, you specify which measurement curve you want to analyze by selecting the related axis: Y1 or Y2 secondary softkey.

In the third bracketed field, you specify how to select a point:

- Select BY X-Y COORDINATE. "AT" is displayed. Then, you enter the desired X-Y coordinate values or expressions in the X: and Y: fields.
- Select BY DATA CONDITION. "WHERE" is displayed. Then, you enter a variable name and condition expression to specify a measurement point.

```
LINE1: [GRAD      ] LINE ON [Y1] between a point [WHERE]
[DGM     ] = [MAX(DGM)*0.01]
[      ]
Gradient: [      ]
```

In addition, you can specify another condition if you position the pointer in the bracketed field above Gradient. Select the AFTER secondary softkey. AFTER is displayed, and you can enter a second variable and condition expression. This sets up a search start condition for finding specified point. (This setup is optional.)

For example, you can specify the following expressions to search for a measurement point that satisfies the first condition after the second condition is satisfied.

```
LINE1: [GRAD      ] LINE ON [Y1] between a point [WHERE]
[DGM     ] = [MAX(DGM)*0.01]
[AFTER] [DGM     ] = [MAX(DGM)]
Gradient: [      ]
```

In a field after Gradient:, you enter a gradient value or expression.

On GRAPH/LIST: GRAPHICS screen, LINE *secondary* softkey must be ON.

Page Organization
DISPLAY Screen Group

Tangent mode line

In the first bracketed field after `LINE1` or `LINE2`, you select the line mode. Select the `TANGENT` secondary softkey to set the tangent line mode. The pointer moves to the second bracketed field as shown:

```
LINE1: [TANGENT ] LINE ON [Y1] between a point where  
[      ] = [      ]  
[      ] [      ] = [      ]
```

In the second bracketed field, you specify which measurement curve you want to analyze by selecting the related axis: `Y1` or `Y2` secondary softkey.

Enter a variable name and condition expression to specify the measurement point for which you want to draw a tangent line.

```
LINE1: [TANGENT ] LINE ON [Y1] between a point where  
[DGM ] = [MAX(DGM)*0.01 ]  
[      ] [      ] = [      ]
```

In addition, you can specify another condition if you position the pointer in the last bracketed field shown above. Select the `AFTER` secondary softkey. `AFTER` is displayed, and you can enter a second variable and condition expression. This sets up a search start condition for finding specified point. (This setup is optional.)

For example, you can specify the following expressions to search for a measurement point that satisfies the first condition after the second condition is satisfied.

```
LINE1: [TANGENT ] LINE ON [Y1] between a point where  
[DGM ] = [MAX(DGM)*0.01 ]  
[AFTER] [DGM ] = [MAX(DGM) ]
```

On `GRAPH/LIST: GRAPHICS` screen, `LINE secondary` softkey must be `ON`.

Regression mode line

In the first bracketed field after LINE1 or LINE2, you select the line mode. Select the REGRESSION secondary softkey to set the regression line mode. For details about regression calculation range, see "Line Drawing" in Chapter 7.

The pointer moves to second bracketed field as shown:

```
LINE1: [REGRESSION] LINE ON [Y1] between a point [AT ]
X: [ ]
Y: [ ]
and a point [AT ]
X: [ ]
Y: [ ]
```

In the second bracketed field, you specify which measurement curve you want to analyze by selecting the related axis: Y1 or Y2 secondary softkey.

In the third bracketed field, you specify how to select a point:

- Select BY X-Y COORDINATE. "AT" is displayed. Then, you enter the desired X-Y coordinate values or expressions in the X: and Y: fields.
- Select BY DATA CONDITION. "WHERE" is displayed. Then, you enter a variable name and condition expression to specify a measurement point.

```
LINE1: [REGRESSION] LINE ON [Y1] between a point [AT ]
X: [0 ]
Y: [0 ]
and a point [WHERE]
[DGM ] = [MAX(DGM)*0.01]
[ ]
```

In addition, you can specify another condition if you position the pointer in the last bracketed field shown above. Select the AFTER secondary softkey. AFTER is displayed, and you can enter a second variable and condition expression. This sets up a search start condition for finding specified point. (This setup is optional.)

For example, you can specify the following expressions to search for a measurement point that satisfies the first condition after the second condition is satisfied.

```
LINE1: [REGRESSION] LINE ON [Y1] between a point [AT ]
X: [0 ]
Y: [0 ]
and a point [WHERE]
[DGM ] = [MAX(DGM)*0.01]
[AFTER] [DGM ] = [MAX(DGM)]
```

Page Organization
DISPLAY Screen Group

On GRAPH/LIST: GRAPHICS screen, LINE *secondary* softkey must be ON.

Marker

In the next line after MARKER: At a point where, you enter a variable name and a condition expression to specify where you want the marker to appear as shown in the following example:

```
MARKER: At a point where  
[DGM ] = [MAX(DGM)*0.01  
[ ] ]
```

In addition, you can specify another condition if you position the pointer in the last bracketed field shown above. Select the AFTER secondary softkey. AFTER is displayed, and you can enter a second variable and condition expression. This sets up a search start condition for finding specified point. (This setup is optional.)

For example, you can specify the following expressions to search for a measurement point that satisfies the first condition after the second condition is satisfied.

```
MARKER: At a point where  
[DGM ] = [MAX(DGM)*0.01  
[AFTER] [DGM ] = [MAX(DGM)
```

Disabling entries

In the field after LINE1, LINE2, or MARKER, you can select the DISABLE secondary softkey to clear the entries, which disables the item for the automatic analysis function.

Interpolation mode

You can also use the interpolation mode for the automatic analysis function by selecting the ON secondary softkey in the Interpolate field. When interpolation mode is on, you can position marker between measurement points. Select OFF to turn interpolation mode to off.

GRAPH/LIST Screen Group

GRAPH/LIST screen group has the following screens:

Graphic Results: For displaying the measurement results graphically. You can use lines or a marker on the graphics screen to analyze the measurement results graphically.

List Results: For listing the measurement results.

To move into the GRAPH/LIST screen group, do one of the following:

- Press Graph/List front-panel key in the PAGE CONTROL key group (if present screen is not GRAPHICS or LIST screen).
- Press Single, Repeat, or Append front-panel key (if present screen is not GRAPHICS or LIST screen). Measurement is performed.

If the present screen is the GRAPHICS or LIST screen, you can toggle between these screens by pressing the Graph/List front-panel key.

On the GRAPHICS result screen

In the primary softkey area of the GRAPHICS screen, the following softkeys are available for performing the manual analysis functions:

For sweep measurements:

AXIS	MARKER/ Y2	LINE CURSOR	SCALING	DISPLAY SETUP	SWEEP SETUP	TIMING SETUP	CONST SETUP
------	---------------	----------------	---------	------------------	----------------	-----------------	----------------

For sampling measurements:

AXIS	MARKER/ Y2	LINE CURSOR	SCALING	DISPLAY SETUP	SAMPLING SETUP	STOP COND	CONST SETUP
------	---------------	----------------	---------	------------------	-------------------	--------------	----------------

On the LIST result screen

In the primary softkey area of the LIST screen, the following softkeys are available for performing the manual analysis functions:

For sweep measurements:

AXIS	MARKER Y2		SPREAD SHEET	RE- SETUP	SWEEP SETUP	TIMING SETUP	CONST SETUP
------	--------------	--	-----------------	--------------	----------------	-----------------	----------------

For sampling measurements:

AXIS	MARKER Y2		SPREAD SHEET	RE- SETUP	SAMPLING SETUP	STOP COND	CONST SETUP
------	--------------	--	-----------------	--------------	-------------------	--------------	----------------

GRAPH/LIST: GRAPHICS screen

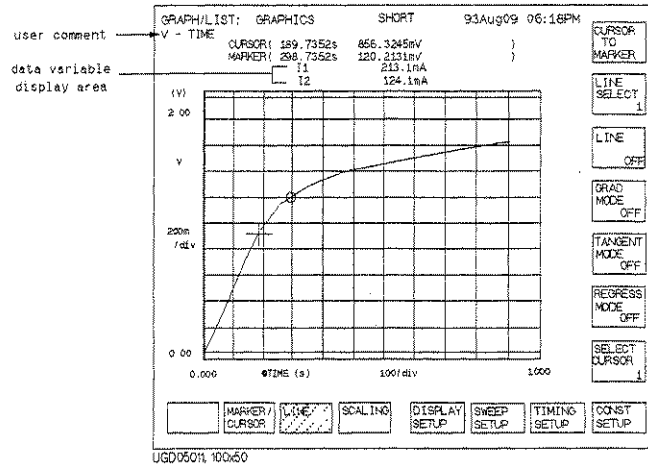

On the "GRAPH/LIST: GRAPHICS" screen, measurement results are displayed, and you can analyze the measurement results graphically.

User Comment

In this field, you can enter a desired comment. This comment is also displayed in the CHANNELS, MEASURE, DISPLAY, and GRAPH/LIST screen groups.

Cursor/marker indicator

In these fields, the coordinate values of the cursor and marker locations are displayed. If cursor or marker is not displayed, these fields are blank. The three fields are for X, Y1, and Y2 coordinate values, respectively.

Data variable display

This area displays the numerical value of up to two variables that you set up on DISPLAY: DISPLAY SETUP screen. These are values at the marker position.

Plotting area

In this area, measurement curves are drawn according to measurement results.

You can analyze measurement results by using lines or marker in this area. If you use lines, the X and Y intercept points and gradient are displayed.

AXIS Y1 softkey

Select **AXIS** primary softkey to toggle active axis between the Y1 and Y2 axes (this softkey is displayed only if Y2 axis is used). The active axis name is displayed on the **AXIS** primary softkey.

For tangent or regression lines, the active line selected by **LINE SELECT** softkey is independent for each axis.

MARKER/CURSOR softkey

Select **MARKER/CURSOR** primary softkey to display secondary softkeys for performing analysis with marker and cursor.

- **MARKER softkey**

Select **MARKER** secondary softkey to toggle the marker on and off. Marker status is displayed on **MARKER** secondary softkey. If on, marker is displayed in the plotting area. If off, marker is not displayed.

For Y1 axis, marker is a circle (o). For Y2 axis, marker is an asterisk (*). Active marker is highlighted for the axis that is selected by **AXIS** softkey.

The 4155B/4156B remembers the location of marker. That is, when marker is turned off, then redisplayed, it appears at its previous location.

- **MARKER MIN/MAX softkey**

Select **MARKER MIN/MAX** secondary softkey to move the marker to the maximum or minimum measurement point value. The search direction is from present to last measurement point, then from first to present measurement point.

After the search, the marker moves to the first minimum or maximum value that was found. If you press this softkey *again*, the marker moves to the next minimum or maximum value. If consecutive measurement points have the same minimum or same maximum value, the marker skips the values when you press the softkey again.

- **INTERPOLATE softkey**

Select **INTERPOLATE** secondary softkey to toggle the interpolation mode. If interpolation mode is on, marker can move on line between adjacent measurement points. If interpolation mode is off, marker can be positioned on measurement points only (not between measurement points).

Page Organization
GRAPH/LIST Screen Group

- DIRECT MARKER/CURSOR softkey

Select DIRECT MARKER/CURSOR secondary softkey to display secondary softkeys for positioning the marker and cursor. A pointer appears in the CURSOR and MARKER coordinate fields. These fields are displayed only if cursor and marker are displayed in the plotting area.

You can move the pointer to the desired field by using the left arrow, upper arrow, right arrow and down arrow MARKER/CURSOR keys. To move marker and cursors to desired position, enter coordinate values into corresponding fields as follows:

- Enter the value by using numeric keys.
- Change the value by rotating rotary knob.

Select CANCEL primary softkey to move marker and cursor back to original position, and exit the direct marker and cursor function. Select EXIT primary softkey to exit the direct marker and cursor function.

The marker can move on the measurement curve *only*, so changing the X value automatically changes the Y value, and vice versa. If the interpolation mode is off, the marker moves to the measurement point that is closest to the specified coordinate.

If the pointer is in a MARKER coordinate field, the following softkeys appear:

- Select MIN/MAX secondary softkey to move marker to minimum measurement value. If marker is at minimum value, marker moves to maximum value.
- Select INTERPOLATE secondary softkey to toggle the interpolation mode on or off. The present mode is displayed on the INTERPOLATE softkey.
- Select SEARCH MORE secondary softkey to move marker to the next candidate (when more than one measurement point satisfies the specified value).
- Select MARKER SKIP secondary softkey to move the marker to the next measurement curve that was added by VAR2 variable or append measurement.

If the pointer is in a CURSOR coordinate field, the following softkey appears:

- Select MIN/MAX secondary softkey to move cursor to minimum axis point. If cursor is at minimum point, cursor moves to maximum point.

NOTE

When a specified value is inappropriate, marker or cursor is located as follows:

- marker
 - If the specified value for marker is greater or less than the maximum or minimum measurement value, the marker moves to the maximum or minimum *measurement point*.
- cursor
 - If a specified value for cursor is greater or less than maximum or minimum scale value, cursor moves to the maximum or minimum *axis point*.

-
- **MARKER SKIP** softkey

Select **MARKER SKIP** secondary softkey to move the marker to the next measurement curve that was added by VAR2 variable or append measurement.

- **CURSOR** softkey

Select **CURSOR** secondary softkey to toggle the cursor display. The cursor status changes between OFF, SHORT, and LONG, which is shown on the **CURSOR** softkey.

- **AUTO ANALYSIS** softkey

Select **AUTO ANALYSIS** secondary softkey to redisplay the auto-analysis that was originally displayed after the measurement was finished.

LINE softkey

Select LINE primary softkey to display the secondary softkeys for performing manual analysis that uses lines.

- CURSOR TO MARKER softkey

Select CURSOR TO MARKER secondary softkey to move the cursor to the marker position.

- LINE SELECT softkey

Selecting this secondary toggles as follows:

1 line 1 is selected, and can be operated on.

2 line 2 is selected, and can be operated on.

NONE no lines are selected. The line secondary softkeys disappear.

You use the following softkeys to operate on each line. LINE SELECT setting is not changed by auto-analysis function.

- LINE softkey

Select LINE secondary softkey to toggle the line mode between OFF and ON. You can set up two lines for each axis.

OFF Line selected by LINE SELECT softkey disappears.

ON Line selected by LINE SELECT softkey is displayed.

If ON is displayed on this softkey, and OFF is displayed on GRAD MODE, TANGENT MODE, and REGRESS MODE softkeys, the line mode is normal.

If you display lines by auto-analysis functions, you need to set LINE softkey to ON in advance.

- GRAD MODE softkey

Select GRAD MODE secondary softkey to change the line mode to gradient mode. If present mode is gradient mode, ON is displayed on the GRAD MODE softkey.

For gradient line mode, GRAD VALUE secondary softkey is displayed. If line mode is gradient mode, selecting GRAD MODE softkey changes to normal mode.

- **TANGENT MODE softkey**

Select TANGENT MODE secondary softkey to change the line mode to tangent mode. If present mode is tangent mode, ON is displayed on the TANGENT MODE softkey.

For tangent line mode, MARKER SKIP secondary softkey is displayed. When line mode is tangent mode, selecting TANGENT MODE softkey changes to normal mode.
- **REGRESS MODE softkey**

Select REGRESS MODE secondary softkey to change the line mode to regression mode. If present mode is regression mode, ON is displayed on the REGRESS MODE softkey.

For regression line mode, SELECT CURSOR secondary softkey is displayed. When line mode is regression mode, selecting REGRESS MODE softkey changes to normal mode.
- **SELECT CURSOR softkey**

Select SELECT CURSOR secondary softkey to exchange the active and non-active cursors. Active cursor is highlighted. This softkey is displayed only when line mode is normal or regression.
- **GRAD VALUE softkey**

Select GRAD VALUE secondary softkey to change the gradient value. The present gradient value is shown on this softkey and in the data entry area. This softkey is displayed only when line mode is gradient. You can change the value as follows:

 - Enter number by using numeric keys.
 - Change number by rotating rotary knob.
- **MARKER SKIP softkey**

Select MARKER SKIP secondary softkey to move the marker to the next measurement curve that was added by VAR2 variable or append measurement. This softkey is displayed only when line mode is tangent.

SCALING softkey

Select SCALING primary softkey to display secondary softkeys for enlarging or reducing the plotting area.

- **AUTO SCALING softkey**

Select AUTO SCALING secondary softkey to change the X and Y scaling to fit the measurement curve in the plotting area. If Y2 axis is used, the measurement curve selected by AXIS primary softkey is auto scaled.

- **ZOOM IN softkey**

Select ZOOM IN secondary softkey to display the area around the cursor with double resolution. If the cursor is not displayed, long cursor appears at the center, then presently displayed area becomes double resolution around the cursor.

- **ZOOM OUT softkey**

Select ZOOM OUT secondary softkey to display the area around the cursor with half resolution. If the cursor is not displayed, long cursor appears at the center, then presently displayed area becomes half resolution around the cursor.

- **CENTER AT CURSOR softkey**

Select CENTER AT CURSOR secondary softkey to center the display around the cursor at the same resolution. If a cursor is not displayed, a long cursor appears at the center.

- **CURSOR TO MARKER softkey**

Select CURSOR TO MARKER secondary softkey to move the cursor to the marker position. Both marker and cursor must be displayed.

- **CANCEL SCALING softkey**

Select CANCEL SCALING secondary softkey to redraw the plotting area with the original settings (most recent DISPLAY: DISPLAY SETUP screen settings or RE-SETUP GRAPH settings).

DISPLAY SETUP softkey

Select DISPLAY SETUP primary softkey to display secondary softkeys for setting or changing the display.

- **RE-SETUP GRAPH softkey**

Select RE-SETUP GRAPH secondary softkey to change the user comments, variable name for each axis, minimum and maximum values for each axis, scale mode of each axis, and displayed data variables.

After you select this softkey, a pointer (highlight) appears on a setup parameter of the graph. You can move the pointer to the desired parameter by using the left arrow, upper arrow, right arrow and down arrow MARKER/CURSOR keys.

When the pointer is located in the user comment field, the present user comment is displayed in the data entry area, which you can edit by using the front panel keys.

When the pointer is located in the variable name field for X, Y1, or Y2 axis, allowable variable names are shown in the secondary softkey area. You can select secondary softkey to change the variable name for each axis. Measurement units change automatically according to variable you select.

When the pointer is located in the maximum or minimum value field for an axis, the present maximum or minimum value is displayed in the data entry area, which you can change by using rotary knob, arrow keys, or numeric keys of the front panel.

When the pointer is located in the scale value field for an axis, LINEAR and LOG secondary softkeys are displayed. So, you can select linear or logarithmic axis mode.

When the pointer is located in the variable name field of the data variable display area, allowable variable names are shown in the secondary softkey area. Measurement units change automatically according to variable you select.

- **GRID softkey**

Select GRID secondary softkey to toggle the grid on or off in the plotting area. The present status of the grid is shown on the GRID softkey.

- **DATA VAR softkey**

Select DATA VAR secondary softkey to toggle on or off the display of data variable values. The present status of the display of the data variable display is shown on the DATA VAR softkey.

Page Organization
GRAPH/LIST Screen Group

- LINE PRMTRS softkey

Select LINE PRMTRS secondary softkey to toggle on or off the display of line parameters (X and Y intercepts and gradients). Line parameters are displayed when *both* of the following are true:

- ON is set on this softkey
- line is displayed in the plotting area.

- OVERLAY PLANE softkey

Select OVERLAY PLANE to control which internal memory measurement curve is overlaid. This softkey toggles the internal memory number as follows:

OFF → 1 → 2 → 3 → 4 → OFF

- SHOW OVERLAY INFO softkey

Select SHOW OVERLAY INFO secondary softkey to display the following for the overlay plane: axes, cursor, marker, and data variables. Select DONE primary softkey to remove information.

- SCALE TO OVERLAY softkey

Select SCALE TO OVERLAY secondary softkey to force the present scaling values to that of overlaid plane even if unit of axis is different.

SWEEP SETUP softkey

Select SWEEP SETUP primary softkey to display secondary softkeys for changing the sweep source parameters. This softkey is displayed only when SWEEP is selected in the MEASUREMENT MODE field on the CHANNELS: CHANNEL DEFINITION screen.

To change the values on the secondary softkeys: enter number by *using numeric keys* or change number by *rotating rotary knob*.

- **VAR1 START softkey**
Select VAR1 START secondary softkey to change the start value of the primary sweep VAR1. The present start value is shown on this softkey and in the data entry area. Then you can change the value.
- **VAR1 STOP softkey**
Select VAR1 STOP secondary softkey to change the stop value of the primary sweep VAR1. The present stop value is shown on this softkey and in the data entry area. Then you can change the value.
- **VAR1 STEP softkey**
Select VAR1 STEP secondary softkey to change the step value of the primary sweep VAR1. The present step value is shown on this softkey and in the data entry area. Then you can change the value.
- **COMP softkey**
Select COMP secondary softkey to change the compliance and power compliance values of the primary sweep VAR1. The present V or I compliance value is shown on the middle line of this softkey, and the present power compliance value is shown on the last line of this softkey.
Selecting COMP softkey highlights this softkey, and the present I or V compliance value appears in the data entry area. Then you can change the value.
Then selecting COMP softkey *again* displays the present power compliance value in data entry area. Then you can change the value. To disable power compliance, you enter 0 (zero) or OFF.
- **VAR2 START softkey (displayed only if VAR2 is defined)**
Select VAR2 START secondary softkey to change the start value of the secondary sweep VAR2. The present start value is shown on this softkey and in the data entry area. Then you can change the value.

Page Organization
GRAPH/LIST Screen Group

- VAR2 STEP softkey (displayed only if VAR2 is defined)

Select VAR2 STEP secondary softkey to change the step value of the secondary sweep VAR2. The present step value is shown on this softkey and in the data entry area. Then you can change the value.

- COMP softkey (displayed only if VAR2 is defined)

Select COMP secondary softkey to change the compliance and power compliance values of the secondary sweep VAR2. The present V or I compliance value is shown on the middle line of this softkey, and the present power compliance value is shown on the last line of this softkey.

Selecting COMP softkey highlights this softkey, and the present I or V compliance value appears in the data entry area. Then you can change the value.

Then selecting COMP softkey *again* displays the power compliance value in the data entry area. You can change the value. To disable the power compliance, enter 0 (zero) or OFF.

TIMING SETUP softkey

Select TIMING SETUP primary softkey to display secondary softkeys for changing the hold time, delay time, and SMU pulse parameters. This softkey is displayed only when SWEEP is selected in the MEASUREMENT MODE field on the CHANNELS: CHANNEL DEFINITION screen.

To change the values on the secondary softkeys: enter number by *using numeric keys* or change number by *rotating rotary knob*.

- **HOLD TIME softkey**
Select HOLD TIME secondary softkey to change the hold time for the sweep measurement. The present hold time is shown on this softkey and in the data entry area. Then you can change the value. You can change the hold time while measurement is being performed.
- **DELAY TIME softkey**
Select DELAY TIME secondary softkey to change the delay time for the sweep measurement. The present delay time is shown on this softkey and in the data entry area. Then you can change the value. You can change the delay time while measurement is being performed. This softkey is not displayed when an SMU is set to VPULSE or IPULSE in the MODE field on the CHANNELS: CHANNEL DEFINITION screen.
- **PULSE BASE softkey (displayed only if SMU pulse source is defined)**
Select PULSE BASE secondary softkey to change the base value of SMU pulse. The present base value is shown on this softkey and in the data entry area. Then you can change the value.
- **PULSE PERIOD softkey (displayed only if SMU pulse source is defined)**
Select PULSE PERIOD secondary softkey to change the period of SMU pulse. The present period is shown on this softkey and in the data entry area. Then you can change the value.
- **PULSE WIDTH softkey (displayed only if SMU pulse source is defined)**
Select PULSE WIDTH secondary softkey to change the pulse width of SMU pulse. The present pulse width is shown on this softkey and in the data entry area. Then you can change the value.

SAMPLNG SETUP softkey

Select SAMPLNG SETUP primary softkey to display secondary softkeys for changing the sampling parameters. This softkey is displayed only when SAMPLING is selected in the MEASUREMENT MODE field on the CHANNELS: CHANNEL DEFINITION screen.

To change the values on the secondary softkeys: enter number by *using numeric keys* or change number by *rotating rotary knob*.

- **SAMPLNG MODE softkey**

Select SAMPLNG MODE secondary softkey to change the sampling mode. Selecting this softkey changes the sampling mode in the following order:

LINEAR → LOG10 → LOG25 → LOG50 → THINNED → LINEAR

- **INITIAL INTRVAL softkey**

Select INITIAL INTRVAL secondary softkey to change the initial interval time for sampling measurements. The present initial interval time is shown on this softkey and in the data entry area. You can change the value.

- **NO. OF SAMPLES softkey**

Select NO. OF SAMPLES secondary softkey to change number of samples. Present number of samples is shown on this softkey and in data entry area. Then you can change the value.

- **TOT SAM TIME softkey**

Select TOT SAM TIME secondary softkey to change the total sampling time for the sampling measurements. The present total sampling time is shown on this softkey and in the data entry area. Then you can change the value.

- **HOLD TIME softkey**

Select HOLD TIME secondary softkey to change the hold time for sampling measurements. The present hold time is shown on this softkey and in the data entry area. Then you can change the value. You can change the hold time while measurement is being performed.

STOP COND softkey

Select STOP COND primary softkey to display secondary softkeys for changing the sampling parameters. This softkey is displayed only when SAMPLING is selected in the MEASUREMENT MODE field on the CHANNELS: CHANNEL DEFINITION screen.

To change the values on the secondary softkeys: enter number by *using numeric keys* or change number by *rotating rotary knob*.

- **STOP COND softkey**
Select STOP COND secondary softkey to enable or disable the stop condition. Selecting this softkey toggles between ENABLE and DISABLE.
- **ENABLE DELAY softkey**
Select ENABLE DELAY secondary softkey to change the enable delay time for the stop condition. The present enable delay time is shown on this softkey and in the data entry area. Then you can change the value.
- **THRESHOLD softkey**
Select THRESHOLD secondary softkey to change threshold value of the stop condition. The present threshold value is shown on this softkey and in the data entry area. Then you can change the value.
You can change the threshold value while measurement is being performed.
- **EVENT TYPE softkey**
Select EVENT TYPE secondary softkey to change the event type. Selecting this softkey changes the event type in the following order:
Val>Th → Val<Th → |Val|>|Th| → |Val|<|Th| → Val>Th
- **EVENT NUMBER softkey**
Select EVENT NUMBER secondary softkey to change the event number of stop condition. The present event number is shown on this softkey and in the data entry area. Then you can change the value.

Page Organization
GRAPH/LIST Screen Group

CONST SETUP setup

Select CONST SETUP primary softkey to display secondary softkeys for changing the constant source parameters. This softkey is displayed only when CONST is set in the FCTN field on CHANNELS: CHANNEL DEFINITION screen.

Output source names appear on the secondary softkeys, and the present output value and compliance also appears. For example, when a output source named "Vce" is defined "5.0 V output with 100 mA compliance," the following softkey appears:

```
Vce
5.00 V
100.mA
```

Select the secondary softkey that you want to change. The selected softkey is highlighted, and the present output value appears in the data entry area. You can change the value.

Then selecting the same softkey *again* displays the present compliance in the data entry area. You can change the compliance.

Use the following methods to change the value:

- Enter number by using numeric keys.
- Change number by rotating rotary knob.

GRAPH/LIST: LIST screen

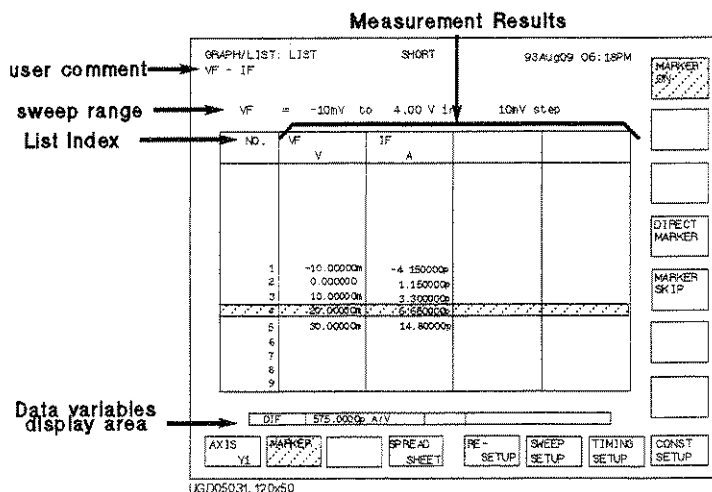

On the "GRAPH/LIST: LIST" screen, measurement results are displayed.

User Comment

In this field, you can enter a desired comment. This comment is also displayed in the CHANNELS, MEASURE, DISPLAY, and GRAPH/LIST screen groups.

Sweep Range

This field displays sweep start, stop, and step values of VAR1 primary sweep and VAR2 secondary sweep (if VAR2 sweep is selected).

List Index Number

This column displays index number of each measurement point. Index number is assigned from 1 in increasing order.

For a VAR2 secondary sweep, the index continues to increase for each VAR2 step, that is, each VAR2 measurement does *not* start at index 1. For example, if VAR1 has 5 steps, then the first VAR2 step is index 1 to 5, second VAR2 step is index 6 to 10, and so on.

If you have appended measurements, index number for each append measurement starts at 1.

Page Organization
GRAPH/LIST Screen Group

In this column head, you can confirm how many append measurements you have executed and which append you are currently viewing. Refer to the following example:

2 / 4

If the above appears in the column head, it means you have appended three measurements to the original measurement (total four measurements), and you are currently viewing the second measurement (first append measurement).

Measurement Results

These columns display measurement result data for the variables that you set up in the LIST area on the DISPLAY: DISPLAY SETUP screen.

Data Variable Display

This area displays the numerical value for the variables that you set up in the DATA VARIABLES area on DISPLAY: DISPLAY SETUP screen. This is the value of the variable at the marker position.

AXIS Y1 softkey

For GRAPH/LIST: GRAPHICS screen, this softkey is used to toggle active axis to analyze between the Y1 and Y2 axis.

For GRAPH/LIST: LIST screen, this softkey only has meaning for the data variable fields, which are just above the primary softkeys. If you set up a data variable that uses a line or marker read-out function, selecting this softkey changes displayed data variable value according to read-out function.

This softkey is displayed only if Y2 axis is set up.

MARKER softkey

Select MARKER primary softkey to display secondary softkeys for operation with marker.

- MARKER softkey

Select MARKER secondary softkey to toggle marker display between ON and OFF. When ON is displayed on this softkey, the row at marker location is highlighted. When OFF is displayed on this softkey, no row is highlighted.

The marker on the GRAPH/LIST: LIST screen is linked to marker on the GRAPH/LIST: GRAPHICS screen. So, if marker is moved on the GRAPH/LIST: GRAPHICS screen, the marker also moves on the GRAPH/LIST: LIST screen.

The 4155B/4156B remembers the location of marker. So, if you turn marker display OFF, then the marker appears at the same location when you turn marker ON again.

- DIRECT MARKER softkey

Select DIRECT MARKER secondary softkey to move the marker to the specified value directly. When you select this softkey, a cell marker is displayed in the row of the marker, and the primary and secondary softkeys change as follows:

Primary softkeys:

EXIT					CANCEL
------	--	--	--	--	--------

Secondary softkeys:

	MARKER	SEARCH	MARKER		
	MIN/MAX	MORE	SKIP		

In this mode, you can move the marker to a specified value. You enter the value in the data entry area, then the marker moves to the value in list that is closest to the specified value. If you have executed append measurement, the marker moves within the append measurement you refer to.

You use the cell marker to specify the target variable (column). You can move this marker by using the left arrow, up arrow, right arrow, and down arrow MARKER/CURSORS keys.

Selecting EXIT primary softkey exits the DIRECT MARKER function.

Selecting CANCEL primary softkey returns the marker to the same position as before selecting the DIRECT MARKER secondary softkey.

Page Organization
GRAPH/LIST Screen Group

- **MARKER MIN/MAX softkey**
Select MARKER MIN/MAX secondary softkey to move the marker to where the measured value is maximum or minimum value. If the marker is on the minimum value, selecting this softkey moves to the maximum value. Otherwise, selecting this softkey moves to the minimum value.
- **SEARCH MORE softkey**
Select SEARCH MORE secondary softkey to move marker to next candidate that satisfies specified value. If consecutive values also satisfy specified value, the next search starts after the consecutive values.
- **MARKER SKIP softkey**
Select MARKER SKIP secondary softkey to move the marker to the next VAR2 value or to the next appended measurement data.
- **MARKER SKIP softkey**
Select MARKER SKIP secondary softkey to move the marker to the next VAR2 value or to the next appended measurement data.
- **NEXT APPEND softkey**
Select NEXT APPEND secondary softkey to move the marker to the next appended measurement data.

SPREADSHEET softkey

Select SPREAD SHEET primary softkey to display ASCII SAVE window. The following entry fields appear:

FUNCTION: ASCII SAVE	
NAME	<input type="text"/>
UNIT	<input type="text"/>
OUTPUT DATA (INDEX NO)	DELIMITER
<input type="text"/> <--> <input type="text"/>	STRING MARK

Also, the following softkeys appear:

- Select EXECUTE softkey to store result data to diskette file or network disk.
- Select EXIT softkey to exit the ASCII SAVE window.
- Select FILE CATALOG secondary softkey to list the names of all files that are on diskette or network disk. You can select a file name from the list.

ASCII SAVE function automatically adds TXT extension to specified file name.

- NAME

Enter the name of file (without extension) to which you want to save the result data.

- OUTPUT DATA

Enter numbers to specify range of data you want to save. These numbers correspond to NO. column of LIST screen.

- right field: upper limit
- left field: lower limit

Select ALL secondary softkey to specify all result data.

- UNIT

Specify whether to include units (for example, V or mS).

- ON secondary softkey to include units.
- OFF secondary softkey to not include units.

Page Organization

GRAPH/LIST Screen Group

For ON, result data is saved as string data, not numeric data. So result data is saved with specified string marker. For string marker, see description of STRING MARK field. Ineffective value (----) is treated as string, even if you set this field to OFF.

- DELIMITER

Specify the data delimiter:

- SPACE secondary softkey to specify space.
- TAB secondary softkey to specify tab.
- COMMA secondary softkey to specify comma.

- STRING MARK

Specify the string marker:

- NONE secondary softkey to specify no string marker.
- " " secondary softkey to specify double quotes string marker.
- ' ' secondary softkey to specify single quotes string marker.

RE-SETUP softkey

Select RE-SETUP primary softkey to change the user comments, variable name for each column, and displayed data variables.

After you select this softkey, a pointer (highlight) appears on the variable name of the first column. You can move the pointer to the desired parameter by using the left arrow, up arrow, right arrow, and down arrow MARKER/CURSOR keys.

When the pointer is located in the user comment field, the present user comment appears in the data entry area, and you can edit it using edit keys.

When the pointer is located in the variable name field, allowable variable names are shown in the secondary softkey area. Measurement units change automatically according to variable you select.

When the pointer is located in the data variable display area, allowable variable names are shown in the secondary softkey area. Measurement units change automatically according to variable you select.

SWEEP SETUP softkey

Select SWEEP SETUP primary softkey to display secondary softkeys for changing the sweep source parameters. This softkey is displayed only when SWEEP is selected in the MEASUREMENT MODE field on the CHANNELS: CHANNEL DEFINITION screen.

To change the values on the secondary softkeys: enter number by *using numeric keys* or change number by *rotating rotary knob*.

- **VAR1 START softkey**

Select VAR1 START secondary softkey to change the start value of the primary sweep VAR1. The present start value is shown on this softkey and in the data entry area. Then you can change the value.

- **VAR1 STOP softkey**

Select VAR1 STOP secondary softkey to change the stop value of the primary sweep VAR1. The present stop value is shown on this softkey and in the data entry area. Then you can change the value.

- **VAR1 STEP softkey**

Select VAR1 STEP secondary softkey to change the step value of the primary sweep VAR1. The present step value is shown on this softkey and in the data entry area. Then you can change the value.

- **COMP softkey**

Select COMP secondary softkey to change the compliance and power compliance values of the primary sweep VAR1. The present V or I compliance value is shown on the middle line of this softkey, and the present power compliance value is shown on the last line of this softkey.

Selecting COMP softkey highlights this softkey, and the present I or V compliance value appears in the data entry area. You can change the value.

Then selecting COMP softkey *again* displays the present power compliance value in the data entry area. You can change the value. To disable the power compliance, enter 0 (zero) or OFF.

Page Organization
GRAPH/LIST Screen Group

- VAR2 START softkey (displayed only if VAR2 is defined)

Select VAR2 START secondary softkey to change the start value of the secondary sweep VAR2. The present start value is shown on this softkey and in the data entry area. Then you can change the value.

- VAR2 STEP softkey (displayed only if VAR2 is defined)

Select VAR2 STEP secondary softkey to change the step value of the secondary sweep VAR2. The present step value is shown on this softkey and in the data entry area. Then you can change the value.

- COMP softkey (displayed only if VAR2 is defined)

Select COMP secondary softkey to change the compliance and power compliance values of the secondary sweep VAR2. The present V or I compliance value is shown on the middle line of this softkey, and the present power compliance value is shown on the last line of this softkey.

Selecting COMP softkey highlights this softkey, and the present I or V compliance value appears in the data entry area. You can change the value.

Then selecting COMP softkey *again* displays the power compliance value in the data entry area. You can change the value. To disable the power compliance, enter 0 (zero) or OFF.

TIMING SETUP softkey

Select TIMING SETUP primary softkey to display secondary softkeys for changing the hold and delay time and SMU pulse parameters. This softkey is displayed only when SWEEP is selected in the MEASUREMENT MODE field on the CHANNELS: CHANNEL DEFINITION screen.

To change the values on the secondary softkeys: enter number by *using numeric keys* or change number by *rotating rotary knob*.

- **HOLD TIME softkey**
Select HOLD TIME secondary softkey to change the hold time for the sweep measurement. The present hold time is shown on this softkey and in the data entry area. Then you can change the value. You can change the hold time while measurement is being performed.
- **DELAY TIME softkey**
Select DELAY TIME secondary softkey to change the delay time for the sweep measurement. The present delay time is shown on this softkey and in the data entry area. Then you can change the value. You can change the delay time while measurement is being performed. This softkey is not displayed when an SMU is set to VPULSE or IPULSE in the FCTN field on the CHANNELS: CHANNEL DEFINITION screen.
- **PULSE BASE softkey (displayed only if SMU pulse source is defined)**
Select PULSE BASE secondary softkey to change the base value of SMU pulse. The present base value is shown on this softkey and in the data entry area. Then you can change the value.
- **PULSE PERIOD softkey (displayed only if SMU pulse source is defined)**
Select PULSE PERIOD secondary softkey to change the period of SMU pulse. The present period is shown on this softkey and in the data entry area. Then you can change the value.
- **PULSE WIDTH softkey (displayed only if SMU pulse source is defined)**
Select PULSE WIDTH secondary softkey to change the pulse width of SMU pulse. The present pulse width is shown on this softkey and in the data entry area. Then you can change the value.

Page Organization
GRAPH/LIST Screen Group

SAMPLNG SETUP softkey

Select SAMPLNG SETUP primary softkey to display secondary softkeys for changing the sampling parameters. This softkey is displayed only when SAMPLING is selected in the MEASUREMENT MODE field on the CHANNELS: CHANNEL DEFINITION screen.

- **SAMPLNG MODE softkey**

Select SAMPLNG MODE secondary softkey to change the sampling mode. Selecting this softkey changes the sampling mode in the following order:

LINEAR → LOG10 → LOG25 → LOG50 → THINNED → LINEAR

- **INITIAL INTRVAL softkey**

Select INITIAL INTRVAL secondary softkey to change the initial interval time for sampling measurements. The present initial interval time is shown on this softkey and in the data entry area. Then you can change the value.

- **NO. OF SAMPLES softkey**

Select NO. OF SAMPLES secondary softkey to change the number of samples. The present number of samples is shown on this softkey and in the data entry area. Then you can change the value.

- **TOT SAM TIME softkey**

Select TOT SAM TIME secondary softkey to change the total sampling time for the sampling measurements. The present total sampling time is shown on this softkey and in the data entry area. Then you can change the value.

- **HOLD TIME softkey**

Select HOLD TIME secondary softkey to change the hold time for sampling measurements. The present hold time is shown on this softkey and in the data entry area. Then you can change the value.

You can change the hold time while measurement is being performed.

STOP COND softkey

Select STOP COND primary softkey to display secondary softkeys for changing the sampling parameters. This softkey is displayed only when SAMPLING is selected in the MEASUREMENT MODE field on the CHANNELS: CHANNEL DEFINITION screen.

- **STOP COND softkey**

Select STOP COND secondary softkey to enable or disable the stop condition. Selecting this softkey toggles between ENABLE and DISABLE.

- **ENABLE DELAY softkey**

Select ENABLE DELAY secondary softkey to change the enable delay time for the stop condition. The present enable delay time is shown on this softkey and in the data entry area. Then you can change the value.

- **THRESHOLD softkey**

Select THRESHOLD secondary softkey to change threshold value of the stop condition. The present threshold value is shown on this softkey and in the data entry area. Then you can change the value.

You can change the threshold value while measurement is being performed.

- **EVENT TYPE softkey**

Select EVENT TYPE secondary softkey to change the event type. Selecting this softkey changes the event type in the following order:

Val>Th → Val<Th → |Val|>|Th| → |Val|<|Th| → Val>Th

- **EVENT NUMBER softkey**

Select EVENT NUMBER secondary softkey to change the event number of stop condition. The present event number is shown on this softkey and in the data entry area. Then you can change the value.

Page Organization
GRAPH/LIST Screen Group

CONST SETUP softkey

Select CONST SETUP primary softkey to display secondary softkeys for changing the constant source parameters. This softkey is displayed only when CONST is set in the FCTN field on CHANNELS: CHANNEL DEFINITION screen.

Output source names appear on the secondary softkeys, and the present output value and compliance also appears. For example, when a output source named "Vce" is defined "5.0 V output with 100 mA compliance," the following softkey appears:

```
Vce  
5.00 V  
100.mA
```

Select the secondary softkey that you want to change. The selected softkey and is highlighted, and the present output value appears in the data entry area. You can change the value.

Then selecting the same softkey *again* displays the compliance value in the data entry area. You can change the compliance.

Use the following methods to change the value:

- Enter number by using numeric keys.
- Change number by rotating rotary knob.

STRESS Screen Group

STRESS screen group has the following screens:

- Stress channel definition: For defining the stress channels of the 4155B/4156B, setting up SMU/PG selector, and setting up the trigger.
- Stress setup: For setting the stress parameters.
- Stress force: For monitoring the progress of stress forcing.

To move into the STRESS screen group, do the following:

- Press Stress front-panel key in the PAGE CONTROL key group.

Then the following softkeys appear in the primary softkey area:

<u>CHANNEL</u>	<u>STRESS</u>	<u>STRESS</u>	<u>PREV</u>	<u>NEXT</u>
<u>DEF</u>	<u>SETUP</u>	<u>FORCE</u>	<u>PAGE</u>	<u>PAGE</u>

- Select CHANNEL DEF softkey to move to the STRESS: CHANNEL DEFINITION screen.
- Select STRESS SETUP softkey to move to the STRESS: STRESS SETUP screen.
- Select STRESS FORCE softkey to move to the STRESS: STRESS FORCE screen.

When you press the **Stress** front-panel key in the MEASUREMENT key group, the STRESS: STRESS FORCE screen appears and stress forcing starts.

STRESS: CHANNEL DEFINITION screen

STRESS: CHANNEL DEFINITION 94JAN01 01:30PM

User comment: device 1 (channel-length 1)

#CHANNELS		MEASURE		STRESS	
UNIT	NAME	MODE	NAME	FCN	
SMU1:MP	V1				
SMU2:MP	V2				
SMU3:MP	V3				
SMU4:MP					
SMU5:MP					
SMU6:MP					
VSU1					
VSU2					
POU1		VPULSE		SYNC	
POU2		VPULSE		SYNC	
GNDU					

#SMU/PG SE_SELECTOR	
MEASURE	STRESS
1: SMU	POU
2: SMU	POU
3: OPEN	OPEN
4: OPEN	OPEN

#TRIGGER SETUP
POLARITY POSITIVE

SYNC

CHANNEL DEF. STRESS SETUP STRESS FORCE NEXT PAGE

U605093,00x80

On the "STRESS: CHANNEL DEFINITION" screen, you define how to use the channels for stress force, how to control the SMU/PG selector, and trigger usage in the stress force state.

User Comment

In this field, you can enter a desired comment. The comment you enter here is also displayed on the other STRESS screens.

CHANNELS

CHANNELS table defines the mode, name, and function for the stress state.

- UNIT

This column lists all the source units that are installed in the 4155B/4156B.

- NAME of MEASURE

Source name that was defined for the measurement state (on CHANNELS: CHANNEL DEFINITION screen). For example, if the unit is set to V source mode, the specified VNAME is shown here.

- MODE of STRESS

Output mode for each unit that will be used during stress force state. In the MODE column, allowable modes are shown in the secondary softkey area as follows, and you select a softkey to set an output mode.

- V** dc voltage source
- I** dc current source
- VPULSE** ac voltage source
- COMMON** circuit common
- DELETE ROW** Deletes all entries in row of unit, so unit is not used during stress force. Output switch of unit is open.

Allowable modes for each unit are shown in the following table:

	V	I	VPULSE	COMMON	DELETE ROW
SMU	yes	yes		yes	yes
VSU	yes				yes
PGU	yes		yes		yes
GNDU				yes	yes

When pointer is at *top of this column*, CHANNEL ASSIGN softkey appears:

NOTE

Switching units

To switch the STRESS MODE, NAME, and FCTN assignments for two units, do as follows:

1. Position pointer in top field of STRESS MODE column. CHANNEL ASSIGN softkey appears.
2. Select CHANNEL ASSIGN. Pointer moves to the top field of UNIT column.
3. Use arrow keys in the MARKER/CURSOR key group to move pointer to desired row.
4. Select the secondary softkey of the desired unit. The selected unit appears at the pointer.

Perform steps 3 and 4 until you assign units as desired. Make sure that the same unit is not assigned to multiple rows. Then select EXIT CHANNEL ASSIGN softkey.

Page Organization
STRESS Screen Group

- NAME of STRESS (optional)

Defines stress name that is used as a reference on STRESS: STRESS SETUP screen. In this column, enter a desired name by using alphanumeric keys.

When pointer is in field of this column, DELETE ROW softkey is shown in secondary softkey area: clears all the entries for a unit where the pointer is located, and disables that unit.

Restriction:

- NAME must be 6 or less alphanumeric characters. First character must be alphabet character.

- FCTN of STRESS

This field defines channels to be stress force channels or non-stress force channels. In this field, select:

- SYNC secondary softkey to set channel to stress force channel.
- NSYNC secondary softkey to set channel to non-stress force channel.

The output timing is different for stress force channels and non-stress force channels:

- Non-stress force channels output the source values in the order specified on the MEASURE: OUTPUT SEQUENCE screen *when state changes from idle to stress*.
- Stress force channels output the stress source values simultaneously *when the stress start trigger is received*.

For details about output sequence, refer to “Stress Force Sequence” in Chapter 3.

Restrictions:

- At least *one* channel must be set to SYNC.
- Up to four channels can be set to SYNC.
- If both PGUs are set to pulsed source (VPULSE), you cannot set one PGU to SYNC and other PGU to NSYNC. Both must be set to SYNC or both to NSYNC.

SMU/PG SELECTOR

Agilent 16440A SMU/PG selector's operation is defined in the SMU/PG SELECTOR table. Switches in the SMU/PG selector are controlled as defined in these fields. MEASURE column sets the switch connections for measurement state. STRESS column sets the switch connections for stress force state.

When the pointer is located in this table, the following softkeys appear:

SMU	Will connect DUT to SMU.
PGU	Will connect DUT to PGU.
OPEN	Will disconnect DUT from both SMU and PGU.
PGU OPEN	Will disconnect DUT from both PGU and SMU. But PGU is disconnected by using semiconductor switch. The normal relay switch for PGU stays closed. This is used to prevent the normal relay switch from being damaged. Semiconductor switch has longer life than normal relay switch. Note that CH2 and CH4 do not have this function.

For details about the SMU/PG selector, refer to "SMU/PG Selector Control" in Chapter 3 or *Agilent 16440A SMU/Pulse Generator Selector User's Guide*.

TRIGGER SETUP

In the TRIGGER SETUP table, you can set how to use the trigger function during the stress force state.

- **ENABLE/DISABLE**

In the ENABLE or DISABLE field, select:

- **ENABLE** secondary softkey to enable the trigger function.
- **DISABLE** secondary softkey to disable the trigger function.

- **POLARITY**

In this field, select:

- **POSITIVE** secondary softkey to set positive logic for the output trigger.
- **NEGATIVE** secondary softkey to set negative logic for the output trigger.

Page Organization
STRESS Screen Group

STRESS: STRESS SETUP screen

user comment

STRESS: STRESS SETUP 94JAN01 01:30PM
device 1 (channel-length 1)

*STRESS MODE		*PULSE	
DURATION	1.0ms	UNIT	PGU1 PGU2
*ACCUMULATED STRESS		NAME	
0.0000s		PERIOD	10.00ms 5.00ms
*HOLD TIME		WIDTH	5.00ms 5.00ms
0.000s		DELAY TIME	0.00000s 0.00000s
*FILTER		PEAK VALUE	0.000V 0.000V
OFF		BASE VALUE	0.000V 0.000V
*STRESS		LEADING TIME	100.ns 100.ns
CONTINUE AT ANY	Status	TRAILING TIME	100.ns 100.ns
*CONSTANT		IMPEDANCE	LOW LOW
UNIT	SMUL:MP		
NAME	VSU		
MODE	V		
SOURCE	5.00V		
COMPLIANCE	1.00000A		

0.000000100

CHANNEL DEF STRESS: STRESS FORCE PREV PAGE NEXT PAGE

UR50004, 100260

On the "STRESS: STRESS SETUP" screen, you set the stress parameters.

User Comment

In this field, you can enter a desired comment. The comment you enter here is also displayed on the other STRESS screens.

STRESS MODE

STRESS MODE table specifies the stress mode. When the stress mode is pulse count mode, you specify the number of pulse counts, and when the stress mode is duration mode, you specify the stress duration in seconds. For details of stress mode, refer to "Stress Mode" in Chapter 3. In the first field, select:

- DURATION secondary softkey to set the duration mode. Then, enter the pulse stress duration in the next field by using numeric keys.
- PULSE COUNT secondary softkey to set the pulse count mode. Then, enter the pulse count in the next field by using numeric keys. This softkey appears only for ac stress: PGU set to VPULSE and SYNC.

In the next field, FREE RUN secondary softkey appears. Select the FREE RUN softkey to force stress *continuously*. Entering 0 (zero) also sets to free run mode.

ACCUMULATED STRESS

The ACCUMULATED STRESS field on this screen and on STRESS: STRESS FORCE screen are linked. So, if value is changed on this screen, value is changed to same value on STRESS: STRESS FORCE screen and vice versa.

To change the displayed accumulated stress time, enter the time in this field. Selecting RESET ACCUM STRESS secondary softkey resets the displayed accumulated stress time to 0 (zero).

HOLD TIME

In the HOLD TIME, you can set the hold time. After the stress force state starts, the stress force channels wait the specified hold time, then start forcing stress at the same time.

For details about hold time, see example figure in “Stress Force Sequence” in Chapter 3.

FILTER

FILTER field specifies SMU filter to ON or OFF. If this field is set to ON, overshoot decreases, but settling time takes several ms. If you set dc stress to short stress force time, set OFF in this field if you want the stress signal to be more pulse shaped.

STRESS Status

- Select CONT AT ANY secondary softkey (stress will continue even if an abnormal status occurs). Abnormal status means the following:
 - SMU reaches its compliance setting.
 - Current of VSU exceeds ± 100 mA.
 - SMU or VSU oscillates.
 - A/D converter overflow occurs.
 - Average current of PGU exceeds ± 100 mA.
- Select STOP AT ANY ABNORM secondary softkey (stress will stop if any abnormal status occurs).
- Select STOP AT COMPLIANCE secondary softkey (stress will stop only if SMU reaches its compliance setting).

Page Organization
STRESS Screen Group

STOP AT ANY ABNORM and STOP AT COMPLIANCE secondary softkeys are displayed only when specified duration is more than 10 s. If you set pulse count mode, these secondary softkeys are displayed only when $pulse\ period \times pulse\ count$ is more than 10 s.

Stress stop function is not effective until stress has been forced for 10 s.

PULSE

UNIT and NAME are defined on STRESS: CHANNEL DEFINITION screen.

On the STRESS: CHANNEL DEFINITION screen you set the PGUs as follows:

- ac stress: MODE=VPULSE, FCTN=SYNC
- ac non-stress: MODE=VPULSE, FCTN=NSYNC
- dc stress: MODE=V, FCTN=SYNC
- dc non-stress: MODE=V, FCTN=NSYNC

PULSE table is for setting the pulse output parameters of PGUs:

- PERIOD

This field specifies the pulse period of the PGU. Both PGUs are set to same value.

- WIDTH

This field specifies pulse width, which must be less than pulse period.

- DELAY TIME

This field specifies the delay time from the pulse start time. The delay time must be less than or equal to the pulse period.

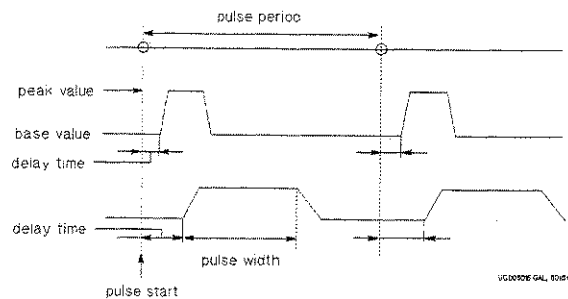

- PEAK VALUE and BASE VALUE
These fields specify pulse peak and base values.
- LEADING TIME and TRAILING TIME
These specify transition time (10 to 90%) of leading and trailing edges.
- IMPEDANCE
This field specifies the PGU output impedance. In this field, select:
 - LOW secondary softkey to set output impedance to about 0 Ω
 - 50 ohm secondary softkey to set output impedance to 50 Ω

CONSTANT

The UNIT, NAME, and MODE are defined on STRESS: CHANNEL DEFINITION screen.

On the STRESS: CHANNEL DEFINITION screen you set the SMUs and VSUs as follows:

- dc stress: MODE= I (SMUs only) or V, FCTN=SYNC
- dc non-stress: MODE=I (SMUs only) or V, FCTN=NSYNC

CONSTANT table is for setting the output parameters of SMUs, VSUs, and PGUs (V mode):

- SOURCE
In the SOURCE field, you specify the output value.
- COMPLIANCE
In the COMPLIANCE field, you specify the compliance value. For a VSU, this field cannot be set: compliance value is fixed to 100 mA.

If you define more than four VSUs, SMUs, and PGUs to be constant stress or non-stress units on the CHANNELS: CHANNEL DEFINITION screen, first four units appear in this table. To show other units, select NEXT UNIT secondary softkey. To scroll units, put field pointer in most right or left column, then press the left arrow or right arrow MARKER/CURSORS front-panel keys.

Page Organization
STRESS Screen Group

STRESS: STRESS FORCE screen

The screenshot shows the "STRESS: STRESS FORCE" screen. At the top left, there is a "user comment" field. The main display area contains the following information:

- STRESS: STRESS FORCE
- 94JAN01 01:30PM
- device 1 (channel-length 1)
- *STRESS (DURATION) 10.0000 s
- *STATUS 5.0000 s 50.00 %
- *ACCUMULATED STRESS 123.4500 s

On the right side, there are four secondary softkey buttons: CHANGE COMMENT, CHANGE DURATION (0.0010), RESET STATUS, and RESET ACCUM STRESS. At the bottom, there are several primary softkey buttons: CHANNEL DEF, STRESS SETUP, STRESS FORCE, and PREV PAGE.

UGD05016, 100x50

On the "STRESS: STRESS FORCE" screen, you can monitor the stress status.

User Comment

In this field, you can enter a desired comment. The comment you enter here is also displayed on the other STRESS screens.

Select CHANGE COMMENT secondary softkey to enter or edit the comment in this field. When you select this softkey, you can enter or edit the comment in the data entry area.

STRESS (DURATION)

STRESS (DURATION) field shows duration setting specified on the STRESS: STRESS SETUP screen. If the STRESS MODE is set to pulse count mode in the STRESS: STRESS SETUP screen, the duration is calculated by multiplying the pulse count by the pulse period.

Depending on the stress mode, select one of the following:

- CHANGE DURATON secondary softkey to change the stress duration.
- CHANGE PLS CNT secondary softkey to change the pulse count.

The stress mode and duration or pulse count were originally set on the STRESS: STRESS SETUP screen. The present stress duration or pulse count is shown on the softkey. When you select the softkey, the present value appears in the data entry area. You change the value as follows:

- Enter number by using numeric and edit keys.
- Change number by rotating rotary knob.

STATUS

In the STATUS field, the time that stress has been forced is displayed in seconds. And the percent completion is also displayed.

To reset stress status to 0, select RESET STATUS secondary softkey. Then, when you press the Stress front-panel key in the MEASUREMENT key group, the stress is forced for the specified duration.

If you press the Stress key after aborting the stress (pressing the Stop front-panel key), the stress is forced starting at the present status, that is, stress status is not reset to 0.

ACCUMULATED STRESS

As the time in the STATUS field increases, the time in the ACCUMULATED STRESS field on this screen and also on STRESS: STRESS SETUP screen increases by the same amount.

To reset accumulated stress on both screens to 0, select RESET ACCUM STRESS secondary softkey. To change to non-zero value, change accumulated stress on STRESS: STRESS SETUP screen.

- For option fields:

When pointer is in an option field, selectable input items for field are displayed on secondary softkeys. You select desired softkey. The item appears in the field.

For example, when pointer is in MEASUREMENT MODE field of CHANNELS: CHANNEL DEFINITION screen, SWEEP and SAMPLING softkeys appear in secondary softkey area. Select SWEEP to select sweep measurement, or select SAMPLING to select sampling measurement.

When pointer is located in a field that requires a variable name, all available variable names are displayed on secondary softkeys, so you can select desired variable name. Available variable names are names you already set up as measurement variables and user function variables. If more than six variable names are available, MORE secondary softkey appears, which you can select to display other available variable names.
- For comment and name fields

When the pointer is located in a comment or name field, you input the desired characters by using the ENTRY front-panel key group. You press the desired characters. The characters appear in the **data entry area**.

For name fields, you can enter alphanumeric characters. For comment fields, you can also enter non-alphanumeric characters. You can enter uppercase or lowercase alphabet characters by using *blue* and *green* front-panel keys. You can enter special (non-alphanumeric) characters by using the *green* front-panel key.

If a comment or name is already entered in the field, it appears in the data entry area. You can edit it using Edit front-panel keys.

After editing or entering the comment or name, press the Enter front-panel key to enter the name or comment into the field at the pointer location.
- For numeric data fields

When pointer is in a numeric data field, input numeric data as follows:

 - Type the numeric value by pressing numeric front-panel keys (value appears in the data entry area). Then, press Enter front-panel key (value is entered into the numeric data field at the pointer location).
 - Rotate the rotary knob to increase or decrease the value. Rotate clockwise to increase value. Rotate counterclockwise to decrease value.

Page Organization
Screen Operation

Blue front-panel key usage

The blue front-panel key has three states:

- Non-shift state** B, b, or G is not displayed in the lower-right corner of the screen. You can enter numeric values.
- Uppercase shift state** B is displayed in the lower-right corner of the screen. G is not displayed. You can enter uppercase alphabet characters.
- Lowercase shift state** b is displayed in the lower-right corner of the screen. You can enter lowercase alphabet characters.

To change between these states:

- toggle between the non-shift/shift state by pressing the blue key.
- toggle between the upper/lowercase shift state by pressing the green key, then the blue key.

The following is a detailed description about changing between these states:

Present Status	Next Status	Key to be pressed
non-shift	Uppercase blue-key shift	blue key
Uppercase blue-key shift	non-shift	blue key
non-shift	Lowercase blue-key shift	green key, then blue key
Lowercase blue-key shift	non-shift	blue key
Uppercase blue-key shift	Lowercase blue-key shift	green key, then blue key
Lowercase blue-key shift	Uppercase blue-key shift	green key, then blue key

Green front-panel key usage

You can use the green front-panel key to enter special (non-alphanumeric) characters, which are printed in green above the keys.

The green key action is momentary. That is, after you press the green key, only the next keystroke is effective. For example, to enter “#\$”, press the green key, 0, green key, and 1.

The green key mode has special functions for entering data, as shown in the following table.

Keys	Label	Function
Green, ←	←	Moves the cursor to the first character.
Green, ⇒	⇒	Moves the cursor to the last character.
Green, Recall↓	Recall↑	Recalls the oldest input from the key buffer. The key buffer stores the 10 most recent entries in the data entry area.
Green, Clear	Clr→End	Clears the entered data from the present cursor position to the end.
Green, Enter	Calc	Calculates any expression entered in the data entry area.

The front-panel green key can also be used to perform dump (Plot/Print key), knob sweep (Single key), and zero offset cancel (Stop key) operations.

Page Organization
Screen Operation

Edit front-panel keys

There are six keys in the Edit front-panel key group. Four of these keys also have other functions in the green-key shift mode. The following table shows the function of each key:

Key	Label	Functions
←		Moves the cursor left by one column in the data entry area.
⇒		Moves the cursor right by one column in the data entry area.
Delete		Deletes one character where the cursor is located.
Insert		Toggles the input mode in the data entry area between <i>insert</i> and <i>overtyping</i> modes.
Recall↓		Recalls the newest input from the key buffer.
Clear		Deletes all the characters in the data entry area.
Green, ←	←	Moves the cursor to the first column in the data entry area.
Green, ⇒	⇒	Moves the cursor to the last column of the present entry in the data entry area.
Green, Recall↓	Recall↑	Recalls the oldest input from the key buffer.
Green, Clear	Clr→End	Deletes the characters from the present cursor position to the end of the entry.

The key buffer stores the 10 most recent entries from the data entry area. You can recall the stored entries using Recall key, as described above.

Page Organization
Status Indicators



Data Variable and Analysis Function

This chapter explains the display and analysis functions of Agilent 4155B/4156B:

- “Data Variable”
- “Expression”
- “Reference: Built-in Function”
- “Read Out Function”
- “Analysis Function”

Data Variable

Data variables are used for displaying and analyzing measurement results. You use data variables to assign output or measurement data to an axis for display.

Each data variable has a name. You refer to a data variable by its name.

The following are the three types of data variable:

- Output or measurement data
- User function
- User variable

Data Variable for Output or Measurement Data

Data variables are available for the following measurement result data:

- Output data that you set for SMU or VSU.
- Measurement data of SMU or VMU.
- Output data that you set for PGU.
- Time data of sampling measurement.
- Index of measurement result data.

Output data of SMU or VSU

The data variable names are the output names that you set in the VNAME or INAME columns of CHANNELS: CHANNEL DEFINITION page. For a voltage MODE, the output name is specified in the VNAME column. For a current MODE, output name is specified in INAME column.

Measurement data of SMU or VMU

The data variable names are the measurement result names that you set in the VNAME or INAME columns of CHANNELS: CHANNEL DEFINITION page. For a voltage MODE, the measurement result name is specified in the INAME column. For a current MODE, measurement result name is specified in VNAME column.

You can get the measurement results by using the measurement result names. If the corresponding SMU or VMU does not perform a measurement, invalid data is returned.

Data Variable and Analysis Function

Data Variable

Output data of PGU

The data variables for PGU output are as follows:

Set data	Data variable name
pulse peak	VNAME for PGU that you defined on CHANNELS: CHANNEL DEFINITION page is the data variable name for pulse peak voltage.
pulse period	@PGT is the data variable for pulse period.
pulse duration	@PGD is the data variable for duration time of pulse stress force. Duration time is the pulse count multiplied by pulse period.
pulse delay time	@PG1DL is the data variable for pulse delay time of PGU1. @PG2DL is the data variable for pulse delay time of PGU2.
pulse width	@PG1W is the data variable for pulse width of PGU1. @PG2W is the data variable for pulse width of PGU2.
pulse base	@PG1B is the data variable for pulse base voltage or current of PGU1. @PG2B is the data variable for pulse base voltage or current of PGU2.
pulse leading	@PG1LD is the data variable for leading-edge transition time of PGU1. @PG2LD is the data variable for leading-edge transition time of PGU2.
pulse trailing	@PG1TR is the data variable for trailing-edge transition time of PGU1. @PG2TR is the data variable for trailing-edge transition time of PGU2.

Time data of sampling measurement

@TIME is the data variable for time data of sampling measurement.

Index of the measurement result data

@INDEX is the data variable for index number of measurement data.

The index number of the first data is 1. For a subordinate sweep measurement, the index number continues to increment by 1 between secondary sweep steps, that is,

- last data of a primary sweep: *index*
- first data of next primary sweep: *index+1*

User Function

A user function consists of one or more data variables used in an expression. You define the user function name, expression, and unit on the CHANNELS: USER FUNCTION DEFINITION page.

You can use a user function inside another user function. And you can set up the user function on the DISPLAY: DISPLAY SETUP pages to plot the user function values or display the numeric value.

To define a user function, you define a name and an expression on the CHANNELS: USER FUNCTION DEFINITION page. If desired, you can define a unit, such as ms.

- User function name must start with alphabet character and can consist of maximum six alphanumeric characters. Name must be unique. Name is case sensitive. For example, Gm is different from gm.
- Unit name is optional. Length: 1 to 6 characters. Valid characters: any characters.

For the syntax of an expression, refer to “Expression” on page 7-8.

Example

To define a user function for mutual conductance gm of an FET, define gm on the CHANNELS: USER FUNCTION DEFINITION page as follows:

NAME	UNIT	DEFINITION
gm	S	$\Delta(I_d) / \Delta(V_g)$

Data Variable and Analysis Function
Data Variable

User Variable

A user variable is a data variable that is a numeric list, which is passed via GPIB commands of PAGE:CHANnels:UVAriable and TRACe|DATA subsystems from an external computer or the Internal IBASIC. For information about the PAGE:CHANnels:UVAriable and TRACe|DATA subsystems, refer to *GPIB Command Reference*.

You can perform calculations between measurement results and the numeric list, or plot the numeric list on the GRAPH/LIST: GRAPHICS page.

You can define up to six user variables. A user variable consists of the following:

user variable name	must start with alphabet character and can consist of maximum six alphanumeric characters. Name must be unique. Name is case sensitive. For example, VTH is different from Vth.
data	numeric list.
unit	Optional. Length: 1 to 6 characters. Valid characters: any characters.

Calculation between variables of different length

If you perform calculation between user variables, or between a user variable and a measurement data variable, and the number of data are different, the extra data in the longer variable are invalid.

Example

Following IBASIC program defines a user variable that has 5 data elements:

```
10 ASSIGN @Hp4155 TO 800
20 OUTPUT @Hp4155;":FORM:DATAASC"
30 OUTPUT @Hp4155;":TRAC:DEF'UVAR1',5"
40 OUTPUT @Hp4155;":TRAC:DATA'UVAR1',1.1,1.2,1.3,1.4,1.5"
50 END
```

- 20 Format of data to be transferred is ASCII format.
- 30 Defines the name of user variable and number of data.
- 40 Transfers the data.

Syntax of Data Variable Name

A data variable name must start with alphabet character and can consist of maximum six alphanumeric characters. Refer to Figure 7-1.

Figure 7-1

Syntax of Data Variable Name

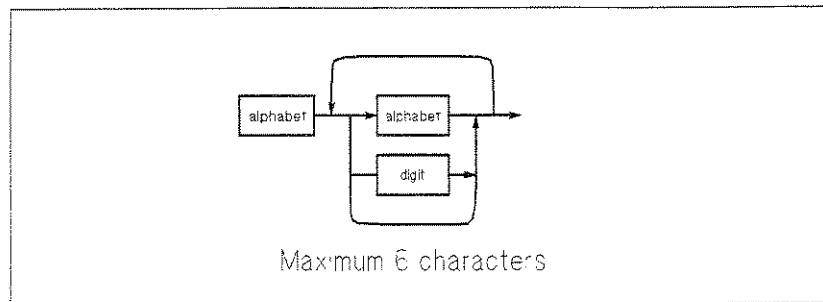

The name must be unique. Name is case sensitive. For example, Gm is different from GM.

NOTE

Using Built-in Function Name as Data Variable Name

You can give a data variable name the same name as a built-in function. But if you use the name in an expression, the system considers the name to be a data variable name, not a built-in function name. So, in this case, you cannot use the built-in function in an expression.

Data Variable and Analysis Function
Expression

Expression

An expression can be used for following:

- In a user function definition
- As a condition for an automatic analysis function
- For direct keyboard calculation

NOTE

Direct Keyboard Calculation

You can directly calculate the value of an expression as follows:

- Enter the expression by using the front-panel keys, press the green key, then press Enter. The value of the expression is displayed.

If the expression contains data variables that are related to measurement points, the calculated value corresponds to the marker position.

Figure 7-2 shows the syntax of an expression. Notice that an expression can be used within an expression.

Figure 7-2 Expression Syntax

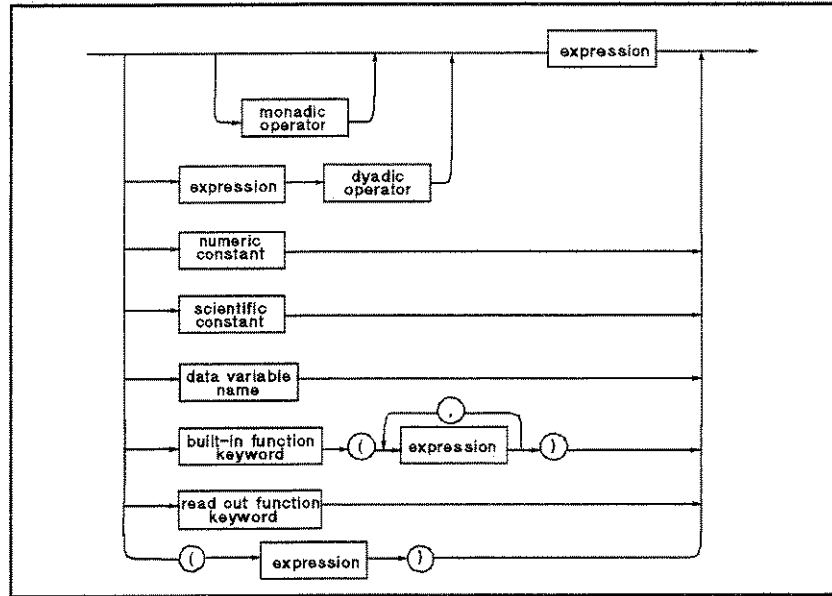

JSGC7001 TED-120

monadic operator

Monadic operator performs operation on expression immediately to its right:

+ positive - negative

dyadic operator

Dyadic operator performs operation between two expressions:

+ addition * multiplication ^ exponentiation
- subtraction / division

NOTE

Operation between data variables

Operation between data variables is performed between data at the same measurement points.

Data Variable and Analysis Function
Expression

numeric constant

Numeric constant can consist of digits, decimal point, and optional exponent notation. Refer to Figure 7-3

Figure 7-3

Numeric Constant

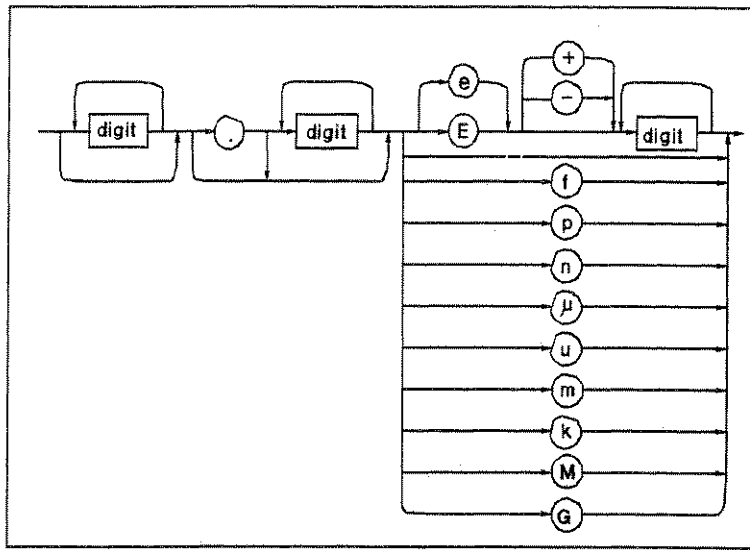

- Mantissa (decimal part) of greater than seven digits is truncated to seven digits.
- The following predefined notations are available:

f	10^{-15}
p	10^{-12}
n	10^{-9}
μ	10^{-6}
u	10^{-6}
m	10^{-3}
k	10^3
M	10^6
G	10^9

numeric constant

Numeric constant can consist of digits, decimal point, and optional exponent notation. Refer to Figure 7-3

The following scientific constants are available:

- q electric charge. 1.60217710^{-19}
- k Boltzmann's constant. 1.38065810^{-23}
- e space permittivity. 8.85418810^{-12}

data variable name

Any data variable name.

read out function keyword

A keyword that invokes the 4155B/4156B's built-in read out function. Refer to "Read Out Function" on page 7-21.

built-in function keyword

A keyword that invokes the 4155B/4156B's built-in function. Refer to "Reference: Built-in Function" on page 7-12.

NOTE

Arithmetic operator precedence

When an expression contains more than one operation, the order of operation is determined by operator precedence. Operations with the highest precedence are performed first. Multiple operations with the same precedence are performed left to right. The following table shows the arithmetic operator precedence.

Precedence	Operator
Highest	Parentheses: (may be used to force any order of operations)
	Functions: built-in function and data variable
	Exponentiation: ^
	Multiplication and division: * /
Lowest	Addition, subtraction, monadic operators: + -

Data Variable and Analysis Function

Reference: Built-in Function

Reference: Built-in Function

You can use built-in functions for the following:

- In the expression that is used to define a user function on the CHANNELS: USER FUNCTION DEFINITION page.
- As the condition for an automatic analysis function on the DISPLAY: ANALYSIS SETUP page.
- For direct keyboard calculations.

The following functions are available:

- ABS
- AT
- AVG
- COND
- DELTA
- DIFF
- EXP
- INTEG
- LGT
- LOG
- MAVG
- MAX
- MIN
- SQRT

ABS

Returns the absolute value of the *expression*.

Syntax *ABS (expression)*

Example To return the absolute value of ID:

ABS (ID)

AT

Returns the value of *1st expression* at the index number specified by the *2nd expression*.

Syntax *AT (1st expression, 2nd expression)*

If *2nd expression* is not integer, linear interpolated value of *1st expression* will be returned.

Example To return difference of Id from its first value:

Id-AT (Id, 1)

AVG

Returns the average value of sweep data or sampling data.

Syntax *AVG (expression)*

For subordinate sweep measurement, this function returns the average value of the primary sweep for the secondary sweep step.

Example To return the absolute value of ID:

AVG (ID)

Data Variable and Analysis Function

Reference: Built-in Function

COND

This function does the following:

- If *1st expression* < *2nd expression*, returns *3rd expression*.
- or
- If *1st expression* ≥ *2nd expression*, returns *4th expression*.

Syntax

COND (*1st expression*, *2nd expression*, *3rd expression*, *4th expression*)

If value of *1st expression* or a *2nd expression* is invalid, the value for the previous measurement index number is used for the comparison.

Example

COND (ID-VG, SQRT (ID) -VG, VD, VGS-VTH)

returns:

- VD if ID-VG < SQRT (ID) -VG.
- VGS-VTH if ID-VG ≥ SQRT (ID) -VG.

DELTA

Returns the difference of the *expression*.

Syntax

DELTA (*expression*)

The difference is defined as follows:

- Basic or synchronous sweep measurement or sampling measurement

$$\delta n = (a_2 - a_1) \quad \text{when } n = 1$$

$$\delta n = (a_{n+1} - a_{n-1})/2 \quad \text{when } 1 < n < N$$

$$\delta n = (a_N - a_{N-1}) \quad \text{when } n = N$$

Where,

δn : difference for measurement index number n .

a_n : value of an *expression* for measurement index number n .

N : number of sweep steps or number of samples.

- Subordinate sweep measurement

For each primary sweep, use same definition as for basic sweep measurement and assume measurement index number 1 for the first step of each primary sweep.

If *expression* is a data variable for a secondary sweep source, this function returns the sweep step value of the secondary sweep.

Example

To return the difference of ID:

DELTA (ID)

Data Variable and Analysis Function

Reference: Built-in Function

DIFF

Returns differential coefficient of *1st expression* by *2nd expression*.

Syntax

DIFF (*1st expression*, *2nd expression*)

The differential coefficient is defined as follows:

- Basic or synchronous sweep measurement or sampling measurement

$$y'_n = (y_2 - y_1)/(x_2 - x_1) \quad \text{when } n = 1$$

$$y'_n = (y_{n+1} - y_{n-1})/(x_{n+1} - x_{n-1}) \quad \text{when } 1 < n < N$$

$$y'_n = (y_N - y_{N-1})/(x_N - x_{N-1}) \quad \text{when } n = N$$

Where,

y'_n : differential coefficient for measurement index number n .

y_n : value of *1st expression* for measurement index number n .

x_n : value of *2nd expression* for measurement index number n .

N : number of sweep steps or number of samples.

- Subordinate sweep measurement

For each primary sweep, use same definition as for basic sweep measurement and assume measurement index number 1 for the first step of each primary sweep.

Example

To return the 2nd order differential coefficient of ID by VG:

DIFF (DIFF (ID, VG), VG)

EXP

Raises e to the power of *expression*.

Syntax

EXP (*expression*)

Example

To raise e to the power of the ID:

EXP (ID)

INTEG

Performs numerical integration of the *1st expression* by the *2nd expression*.

Syntax

INTEG (*1st expression*, *2nd expression*)

This operation is defined as follows:

- Basic or synchronous sweep measurement or sampling measurement
when $n = 1$, $\sigma_n = 0$
when $n > 1$, σ_n is presented by the following equation:

$$\sigma_n = \frac{1}{2} \sum_{i=2}^n (y_i + y_{i-1})(x_i - x_{i-1})$$

Where,

σ_n : integral of *1st expression* for measurement index number n.

y_i : value of *1st expression* for measurement index number i.

x_i : value of *2nd expression* for measurement index number i.

If there are some invalid values in the *expressions*, the invalid values are ignored for the calculation.

- Subordinate sweep measurement

For each primary sweep, use same definition as for basic sweep measurement and assume measurement index number 1 for the first step of each primary sweep.

Example

To integrate ID by VD:

INTEG (ID, VD)

Data Variable and Analysis Function
Reference: Built-in Function

LGT

Returns the logarithm (base 10) of *expression*.

Syntax

LGT (*expression*)

If the *expression* is:

- 0** XXXXXX is returned with status of "Arithmetic error".
- negative value** logarithm of absolute value is returned with status of "Arithmetic error".

Example

To return the logarithm of ID:

LGT (ID)

LOG

Returns the logarithm (base e) of *expression*.

Syntax

LOG (*expression*)

If the *expression* is:

- 0** XXXXXX is returned with status of "Arithmetic error".
- negative value** logarithm of absolute value is returned with status of "Arithmetic error".

Example

To return the logarithm of ID:

LOG (ID)

MAVG

Returns the moving average value of *1st expression*. The *2nd expression* specifies how many measurement points to use for average.

Syntax

MAVG (*1st expression*, *2nd expression*)

This operation is defined as follows:

- Basic or synchronous sweep measurement or sampling measurement

The moving average at measurement index number n is defined as follows:

when $n \leq r$

$$\bar{x}_n = \frac{1}{r+n} \sum_{i=1}^{n+r} x_i$$

when $r < n \leq N-r$

$$\bar{x}_n = \frac{1}{2r+1} \sum_{i=n-r}^{n+r} x_i$$

when $N-r < n$

$$\bar{x}_n = \frac{1}{r+N-n+1} \sum_{i=n-r}^N x_i$$

Where,

\bar{x}_n : moving average of the *1st expression* for measurement index number n .

x_i : value of the *1st expression* for measurement index number i .

r : value of the *2nd expression*.

N : number of sweep steps or number of samples.

If there are some invalid values in the *1st expression*, the invalid values are ignored for the calculation.

- Subordinate sweep measurement

For each primary sweep, use same definition as for basic sweep measurement and assume measurement index number 1 for the first step of each primary sweep.

Data Variable and Analysis Function

Reference: Built-in Function

Example

To return the moving average value of "ID" by using five measurement values:

MAVG (ID, 5)

MAX

Returns the maximum sweep or sampling value.

Syntax

MAX (*expression*)

For subordinate sweep measurement, this function returns the maximum value of the primary sweep for the secondary sweep step.

If there are invalid values in *expression*, invalid values are ignored.

Example

To return the maximum value of ID:

MAX (ID)

MIN

Returns the minimum sweep or sampling value.

Syntax

MIN (*expression*)

For subordinate sweep measurement, this function returns the minimum value of the primary sweep for the secondary sweep step.

If there are invalid values in *expression*, invalid values are ignored.

Example

To return the minimum value of ID:

MIN (ID)

SQRT

Returns the square root of the *expression*.

Syntax

SQRT (*expression*)

Example

To return the square root of ID:

SQRT (ID)

Read Out Function

The read out functions are built-in functions for reading various values related to the maker, cursor, or line. You can use these functions to perform complex analysis of the measurement results.

You can use read out functions for the following:

- In the expression that is used to define a user function on the CHANNELS: USER FUNCTION DEFINITION page.
- As a condition for an automatic analysis function on the DISPLAY: ANALYSIS SETUP page.
- For direct keyboard calculations.

The following functions are available:

Function	Read Out Function
Marker	@MI, @MX, @MY, @MY1, @MY2
Cursor	@CX, @CY, @CY1, @CY2
Line	@IX, @IY, @IY1, @IY2, @L1CO, @L1G, @L1G1, @L1G2, @L1X, @L1Y, @L1Y1, @L1Y2, @L2CO, @L2G, @L2G1, @L2G2, @L2X, @L2Y, @L2Y1, @L2Y2

The following are restrictions for using read out functions:

- GRAPHICS must be selected in the DISPLAY MODE field on the DISPLAY: DISPLAY SETUP page when you use the read out function. If not, invalid data is returned. (@MI is an exception. @MI can be used in GRAPHICS or LIST mode.)
- If the marker, cursor, or line that are referred to by the read out function are not displayed, the read out function uses the position at which it was most recently displayed. If the marker, cursor, and line have not been displayed, the read out function returns invalid data.
- You cannot assign a data variable that includes a read out function to an axis of graphics plot.

Data Variable and Analysis Function
Read Out Function

@CX

Returns the value of X coordinate at the active cursor position.

Syntax: @CX

@CY

Returns the value of Y coordinate at the active cursor position.

Syntax: @CY

If there are Y1 and Y2 axes, this function returns the value for selected axis.

@CY1

Returns the value of Y1 coordinate at the active cursor position.

Syntax: @CY1

@CY2

Returns the value of Y2 coordinate at the active cursor position.

Syntax: @CY2

@IX

Returns the value of X coordinate at the cross point of LINE1 and LINE2.

Syntax: @IX

This function calculates the cross point by using the following formula:

$$x = \frac{y_2 - y_1}{\alpha_2 - \alpha_1}$$

Where,

x : Value of X coordinate at the cross point. If the X axis is logarithmic scale, this function returns 10^x .

y_n : Y-intercept value of LINE n . If the Y axis is logarithmic scale, y_n is the log value of the y intercept of LINE n .

α_n : Slope of LINE n .

If LINE1 is parallel to LINE2, this function returns invalid data with the status "Arithmetic error".

@IY

Returns the value of Y coordinate at the cross point of LINE1 and LINE2.

Syntax: @IY

If there are Y1 and Y2 axes, this function returns the value for selected axis.

This function calculates the cross point by using the following formula:

$$y = \frac{\alpha_1}{\alpha_1 - \alpha_2}(y_2 - y_1) + y_1$$

Where,

y : Value of Y coordinate at the cross point. If the Y axis is logarithmic scale, this function returns 10^y .

y_n : Y-intercept value of LINE n . If the Y axis is logarithmic scale, y_n is the log value of the y intercept of LINE n .

α_n : Slope of LINE n .

If LINE1 is parallel to LINE2, this function returns invalid data with the status "Arithmetic error".

Data Variable and Analysis Function
Read Out Function

@IY1

Returns the value of Y1 coordinate at the cross point of LINE1 and LINE2.

Syntax: @IY1

This function calculates the cross point by using the following formula:

$$y1 = \frac{\alpha_1}{\alpha_1 - \alpha_2}(y_2 - y_1) + y_1$$

Where,

$y1$: Value of Y1 coordinate at the cross point. If the Y1 axis is logarithmic scale, this function returns 10^{y1} .

y_n : Y1-intercept of LINE n . If the Y1 axis is logarithmic scale, y_n is the log value of the Y1 intercept of LINE n .

α_n : Slope of LINE n .

If LINE1 is parallel to LINE2, this function returns invalid data with the status "Arithmetic error".

@IY2

Returns the value of Y2 coordinate at the cross point of LINE1 and LINE2.

Syntax: @IY2

This function calculates the cross point by using the following formula:

$$y2 = \frac{\alpha_1}{\alpha_1 - \alpha_2}(y_2 - y_1) + y_1$$

Where,

$y2$: Value of Y2 coordinate at the cross point. If the Y2 axis is logarithmic scale, this function returns 10^{y2} .

y_n : Y2-intercept of LINE n . If the Y2 axis is logarithmic scale, y_n is the log value of the Y2 intercept of LINE n .

α_n : Slope of LINE n .

If LINE1 is parallel to LINE2, this function returns invalid data with the status "Arithmetic error".

@L1CO

Returns the correlation coefficient of the regression for LINE1.

Syntax: @L1CO

LINE1 must be in regression mode. If not, this function returns invalid data.

@L1G

Returns the slope of LINE1.

Syntax: @L1G

If there are Y1 and Y2 axes, this function returns the value for selected axis.

This function calculates the slope by using the following formula:

- If X and Y axes are both linear scaling:
$$\alpha = (y_1 - y_0)/(x_1 - x_0)$$
- If X axis is logarithmic scaling, and Y axis is linear scaling:
$$\alpha = (y_1 - y_0)/(\log x_1 - \log x_0)$$
- If X axis is linear scaling, and Y axis is logarithmic scaling:
$$\alpha = (\log y_1 - \log y_0)/(x_1 - x_0)$$
- If X and Y axes are both logarithmic scaling:
$$\alpha = (\log y_1 - \log y_0)/(\log x_1 - \log x_0)$$

Where,

α : Slope of LINE1.

x_0, y_0, x_1, y_1 : X and Y coordinate values at the two points where LINE1 intercepts the perimeter of the plotting area.

Data Variable and Analysis Function
Read Out Function

@L1G1

Returns the slope of LINE1 for Y1 axis.

Syntax: @L1G1

This function calculates the slope by using the following formula:

- If X and Y1 axes are both linear scaling:
$$\alpha = (y_1 - y_0)/(x_1 - x_0)$$
- If X axis is logarithmic scaling, and Y1 axis is linear scaling:
$$\alpha = (y_1 - y_0)/(\log x_1 - \log x_0)$$
- If X axis is linear scaling, and Y1 axis is logarithmic scaling:
$$\alpha = (\log y_1 - \log y_0)/(x_1 - x_0)$$
- If X and Y1 axes are both logarithmic scaling:
$$\alpha = (\log y_1 - \log y_0)/(\log x_1 - \log x_0)$$

Where,

α : Slope of LINE1.

x_0, y_0, x_1, y_1 : X and Y1 coordinate values at the two points where LINE1 intercepts the perimeter of the plotting area.

@L1G2

Returns the slope of LINE1 for Y2 axis.

Syntax: @L1G2

This function calculates the slope by using the following formula:

- If X and Y2 axes are both linear scaling:
$$\alpha = (y_1 - y_0)/(x_1 - x_0)$$
- If X axis is logarithmic scaling, and Y2 axis is linear scaling:
$$\alpha = (y_1 - y_0)/(\log x_1 - \log x_0)$$
- If X axis is linear scaling, and Y2 axis is logarithmic scaling:
$$\alpha = (\log y_1 - \log y_0)/(x_1 - x_0)$$
- If X and Y2 axes are both logarithmic scaling:
$$\alpha = (\log y_1 - \log y_0)/(\log x_1 - \log x_0)$$

Where,

α : Slope of LINE1.

x_0, y_0, x_1, y_1 : X and Y2 coordinate values at the two points where LINE1 intercepts the perimeter of the plotting area.

Data Variable and Analysis Function
Read Out Function

@L1X

Returns the X intercept value ($Y=0$) of LINE1.

Syntax: @L1X

If LINE1 is horizontal, this function returns invalid data.

@L1Y

Returns the Y intercept value ($X=0$) of LINE1.

Syntax: @L1Y

If there are Y1 and Y2 axes, this function returns the value for selected axis.

If LINE1 is vertical, this function returns invalid data.

@L1Y1

Returns the Y1 intercept value ($X=0$) of LINE1.

Syntax: @L1Y1

If LINE1 is vertical, this function returns invalid data.

@L1Y2

Returns the Y2 intercept value ($X=0$) of LINE1.

Syntax: @L1Y2

If LINE1 is vertical, this function returns invalid data.

@L2CO

Returns the correlation coefficient of the regression for LINE2.

Syntax: @L2CO

LINE2 must be in regression mode. If not, this function returns invalid data.

@L2G

Returns the slope of LINE2.

Syntax: @L2G

If there are Y1 and Y2 axes, this function returns the value for selected axis.

This function calculates the slope by using the following formula:

- If X and Y axes are both linear scaling:
$$\alpha = (y_1 - y_0)/(x_1 - x_0)$$
- If X axis is logarithmic scaling, and Y axis is linear scaling:
$$\alpha = (y_1 - y_0)/(\log x_1 - \log x_0)$$
- If X axis is linear scaling, and Y axis is logarithmic scaling:
$$\alpha = (\log y_1 - \log y_0)/(x_1 - x_0)$$
- If X and Y axes are both logarithmic scaling:
$$\alpha = (\log y_1 - \log y_0)/(\log x_1 - \log x_0)$$

Where,

α : Slope of LINE2.

x_0, y_0, x_1, y_1 : X and Y coordinate values at the two points where LINE2 intercepts the perimeter of the plotting area.

Data Variable and Analysis Function
Read Out Function

@L2G1

Returns the slope of LINE2 for Y1 axis.

Syntax: @L2G1

This function calculates the slope by using the following formula:

- If X and Y1 axes are both linear scaling:
$$\alpha = (y_1 - y_0)/(x_1 - x_0)$$
- If X axis is logarithmic scaling, and Y1 axis is linear scaling:
$$\alpha = (y_1 - y_0)/(\log x_1 - \log x_0)$$
- If X axis is linear scaling, and Y1 axis is logarithmic scaling:
$$\alpha = (\log y_1 - \log y_0)/(x_1 - x_0)$$
- If X and Y1 axes are both logarithmic scaling:
$$\alpha = (\log y_1 - \log y_0)/(\log x_1 - \log x_0)$$

Where,

α : Slope of LINE2.

x_0, y_0, x_1, y_1 : X and Y1 coordinate values at the two points where LINE2 intercepts the perimeter of the plotting area.

@L2G2

Returns the slope of LINE2 for Y2 axis.

Syntax: @L2G2

This function calculates the slope by using the following formula:

- If X and Y2 axes are both linear scaling:
$$\alpha = (y_1 - y_0)/(x_1 - x_0)$$
- If X axis is logarithmic scaling, and Y2 axis is linear scaling:
$$\alpha = (y_1 - y_0)/(\log x_1 - \log x_0)$$
- If X axis is linear scaling, and Y2 axis is logarithmic scaling:
$$\alpha = (\log y_1 - \log y_0)/(x_1 - x_0)$$
- If X and Y2 axes are both logarithmic scaling:
$$\alpha = (\log y_1 - \log y_0)/(\log x_1 - \log x_0)$$

Where,

α : Slope of LINE2.

x_0, y_0, x_1, y_1 : X and Y2 coordinate values at the two points where LINE2 intercepts the perimeter of the plotting area.

Data Variable and Analysis Function
Read Out Function

@L2X

Returns the X intercept value ($Y=0$) of LINE2.

Syntax: @L2X

If LINE2 is horizontal, this function returns invalid data.

@L2Y

Returns the Y intercept value ($X=0$) of LINE2.

Syntax: @L2Y

If there are Y1 and Y2 axes, this function returns the value for selected axis.

If LINE2 is vertical, this function returns invalid data.

@L2Y1

Returns the Y1 intercept value ($X=0$) of LINE2.

Syntax: @L2Y1

If LINE2 is vertical, this function returns invalid data.

@L2Y2

Returns the Y2 intercept value ($X=0$) of LINE2.

Syntax: @L2Y2

If LINE2 is vertical, this function returns invalid data.

@MI

Returns the index number of measurement data at the marker location.

Syntax: @MI

This function can be used in both GRAPHICS and LIST display modes.

If the interpolation mode is enabled in GRAPHICS display and the marker is located between the measurement data, this function returns a non-integer value.

Data Variable and Analysis Function
Read Out Function

@MX

Returns the value of the X coordinate at the marker location.

Syntax: @MX

@MY

Returns the value of the Y coordinate at the marker location.

Syntax: @MY

If there are Y1 and Y2 axes, this function returns the value for selected axis.

@MY1

Returns the value of the Y1 coordinate at the marker location.

Syntax: @MY1

@MY2

Returns the value of the Y2 coordinate at the marker location.

Syntax: @MY2

Data Variable and Analysis Function
Analysis Function

Analysis Function

The 4155B/4156B provides the following functions for analyzing measurement results:

- “Marker on the GRAPH/LIST: GRAPHICS page”
- “Marker on the GRAPH/LIST: LIST page”
- “Cursor”
- “Line Drawing”
- “Scaling Functions”
- “Overlay Display Function”
- “Automatic Analysis Function”

Marker on the GRAPH/LIST: GRAPHICS page

Figure 7-4

Markers on the GRAPH/LIST: GRAPHICS page

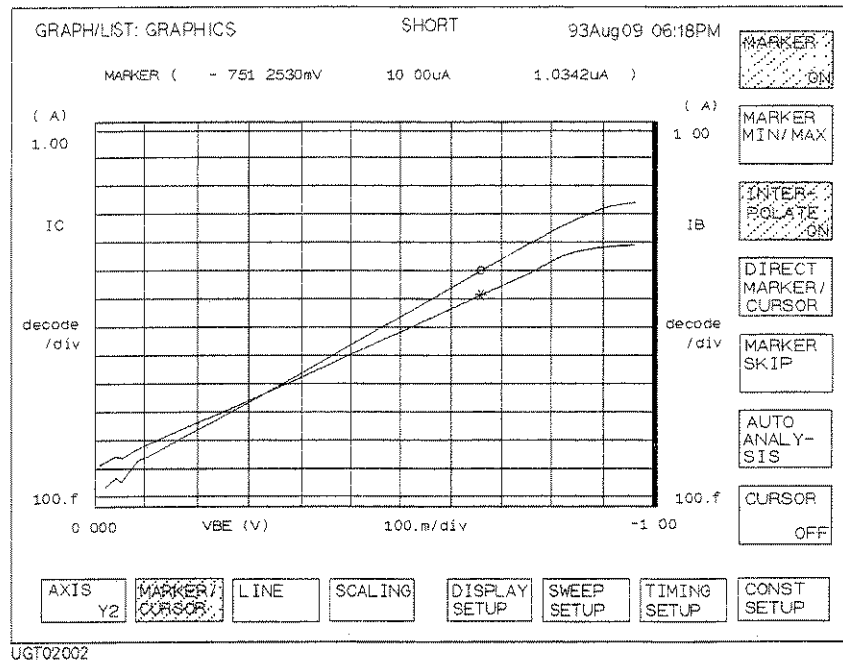

You can display the markers on the plotted measurement curves on the GRAPH/LIST: GRAPHICS page by selecting MARKER/CURSOR primary softkey, then selecting MARKER secondary softkey. The marker for Y1 axis is a circle (o), and the marker for Y2 axis is an asterisk (*). The active marker depends on the selected axis.

Markers have the following functions on the GRAPH/LIST: GRAPHICS page:

- displaying values of measurement curve.
The X, Y1, or Y2 coordinate values at the marker location are displayed.
- specifying a point at which to draw a tangent line
For tangent line mode, the marker is used to specify the position at which to draw a tangent to the measurement curve. Refer to "Line Drawing" on page 7-40.
- displaying values of data variables

Data Variable and Analysis Function Analysis Function

The data variable values at the marker location are displayed.

- specifying the position for direct keyboard calculation

If you enter an expression that has data variables related to measurement points, the value of the expression at the marker position is displayed.

- indicating measurement point determined by auto analysis expression

If you set up an expression for the marker on DISPLAY: ANALYSIS SETUP page, the marker moves to the point determined by the expression after auto analysis is performed.

Moving the marker

Basically, you can move the markers on measurement points of the measurement curve by using the knob on the front panel. In addition to the basic movement, the following functions allow you to quickly move the marker to the desired position.

- Interpolation Mode

Enables you to move the marker on lines between adjacent measurement points.

- Marker to Min/Max

Moves the marker to the maximum or minimum measurement point value.

- Direct Movement

Moves the marker directly to specified coordinates on measurement curve.

- Marker Skip

Moves the marker to the next measurement curve. This function only has meaning for subordinate sweep measurements and append measurements.

Marker on the GRAPH/LIST: LIST page

Figure 7-5

Marker on the GRAPH/LIST: LIST page

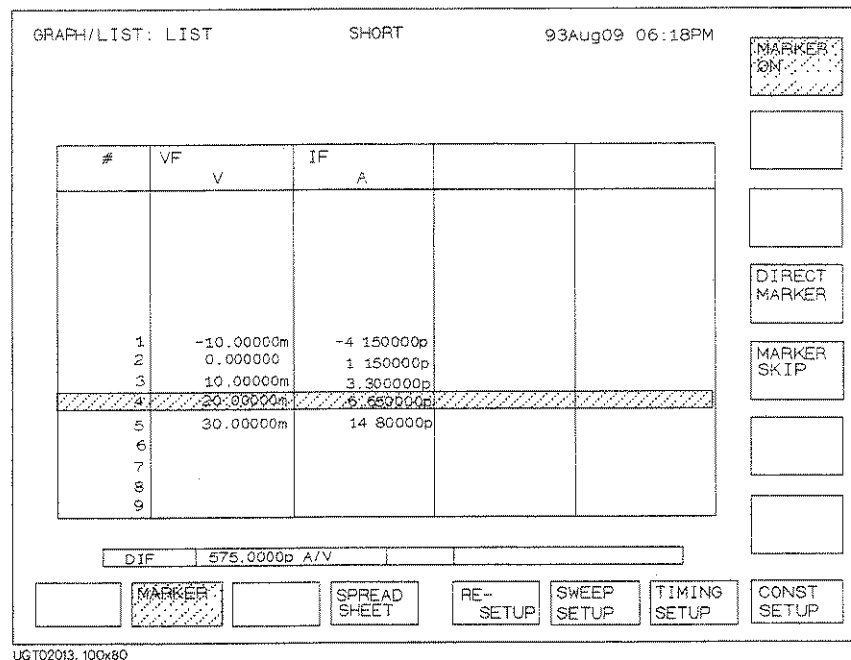

UGT02013, 100x80

When marker function is enabled on GRAPH/LIST: LIST page, a marker (highlighted row) is displayed.

Marker has following functions on this page:

- displaying values of data variables
The data variable values are displayed for the highlighted row.
- specifying the position for direct keyboard calculation
If you enter an expression that has data variables related to measurement points, the value of the expression for the highlighted row is displayed.
- indicating measurement point determined by auto analysis expression
If you set up an expression for the marker on DISPLAY: ANALYSIS SETUP page, the marker moves to the row determined by the expression after auto analysis is performed.

Data Variable and Analysis Function
Analysis Function

Moving the marker

Basically, you can move the marker up or down by using the rotary knob on the front panel or by using the upper arrow and down arrow front-panel keys. If you have defined more than four variable values, you can scroll right or left by using the left arrow or right arrow front-panel key.

In addition to the basic movement, the following functions allow you to quickly move the marker to the desired position. For these functions, the row marker becomes a one cell pointer, so these functions are for the column that contains the pointer, not the entire row.

- **Marker to Min/Max**
Moves the pointer to the maximum or minimum measurement point value.
- **Direct Movement**
Moves the pointer directly to the value that is closest to the specified value.
- **Marker Skip**
Moves the pointer to data for the next measurement curve. This function only has meaning for subordinate sweep measurements and append measurements.

Cursor

Cursors are used to specify the position for line drawing or scaling functions on the GRAPH/LIST: GRAPHICS page. Refer to "Line Drawing" on page 7-40 and "Scaling Functions" on page 7-42.

You can select a short cursor, which is a cross "+", or a long cursor, which is a cross with long lines.

You can move the cursor *anywhere* in the plotting area by using arrow keys of the Marker/Cursor key group.

Figure 7-6

Cursors on the GRAPH/LIST: GRAPHICS page

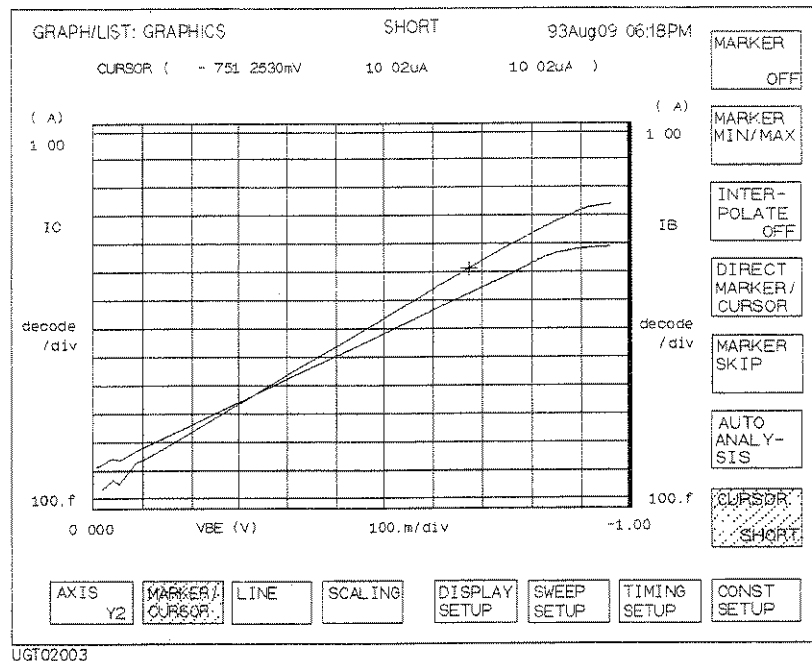

Data Variable and Analysis Function
Analysis Function

Line Drawing

You can draw up to two lines in plotting area on GRAPH/LIST: GRAPHICS page.
To draw lines, you can select one of following four line modes:

- Normal line mode: can draw a line through two cursors.

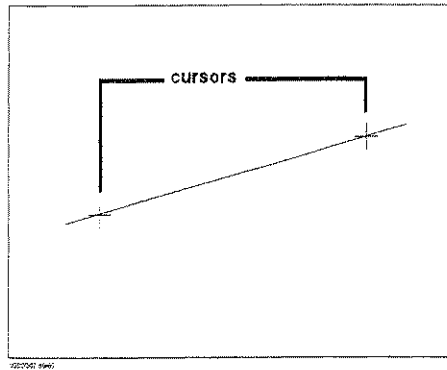

- Grad line mode: can draw a line through a cursor with specified gradient.

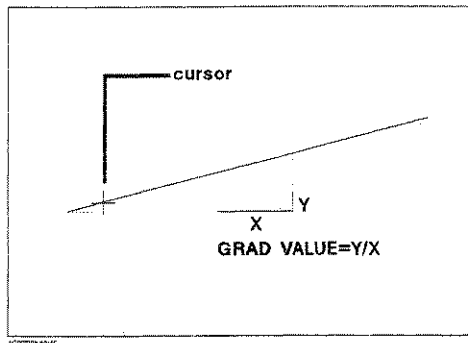

Data Variable and Analysis Function Analysis Function

- Tangent line mode: can draw tangent line to marker, which is on measurement curve.

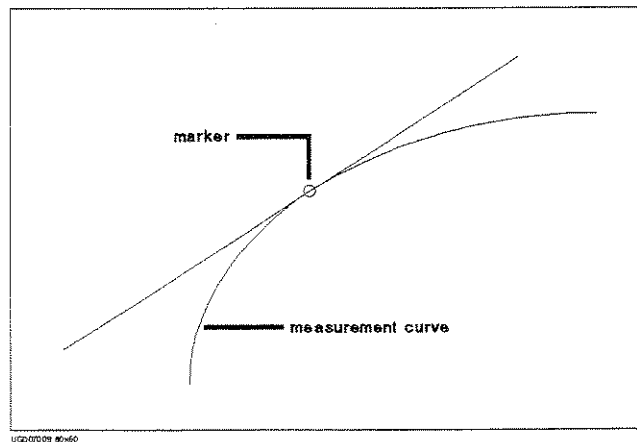

- Regression line mode: can draw regression line within area specified by two cursors.

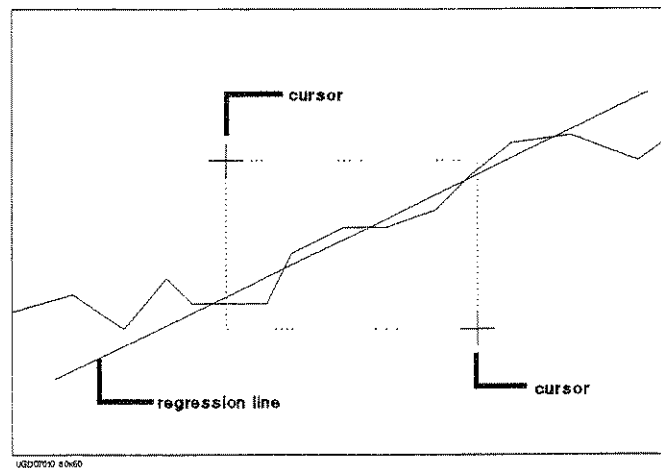

Data Variable and Analysis Function
Analysis Function

Scaling Functions

You can change the axis scales after plotting the measurement results on the GRAPH/LIST: GRAPHICS page. The following scaling functions are provided:

- Autoscaling
Changes X and Y-axis scaling to fit the measurement curve.
- Zooming in
Displays the area around the cursor with double resolution.
- Zooming out
Displays the area around the cursor with half resolution.
- Centering at cursor
Centers the display around the cursor at the same resolution.

Overlay Display Function

You can overlay a measurement curve (that was previously saved into one of the four internal memories) onto the curve that is presently displayed on the GRAPH/LIST: GRAPHICS page. This is useful for comparing measurement results.

Overlay Display Information

You can use following information of overlaid curve instead of present information:

- Axis information
- Cursor and marker position
- List of the data variables

Adjusting axes

You can use the axis scaling of overlaid plane instead of present scaling.

Data Variable and Analysis Function
Analysis Function

Automatic Analysis Function

This function can automatically draw up to two lines and position a marker on the plotting area of the GRAPH/LIST: GRAPHICS page. You set up this function on the DISPLAY: ANALYSIS SETUP page. This function is performed automatically when:

- measurement finishes.
- AUTO ANALYSIS secondary softkey on the GRAPH/LIST: GRAPHICS page is pressed.

The same four line modes as for manual analysis are available: normal, grad, tangent, and regression. For details about these line modes, refer to “Line Drawing” on page 7-40.

Specifying Points for Drawing Lines and Positioning Marker

Two modes are available: X-Y mode and on plot mode. Following table shows which of these modes are available for drawing lines and positioning marker.

Positioning Mode	Line Mode				Marker Positioning
	Normal	Grad	Tangent	Regression	
X-Y	yes	yes	n.a.	yes	n.a.
On plot	yes	yes	yes	yes	yes

- X-Y mode

You can specify *any* point in plotting area by using X and Y coordinate values. Can directly specify coordinate values or specify an expression.

- On plot mode

You can specify a point on the measurement curve by using a data variable and an expression. The measurement point is determined by the point where the data variable is equal to the expression.

You can also specify a second expression that is the starting point of the search. That is, the search for the measurement point that satisfies the first expression does not start until the finding the measurement point that satisfies the second expression.

Data Variable and Analysis Function Analysis Function

Example:

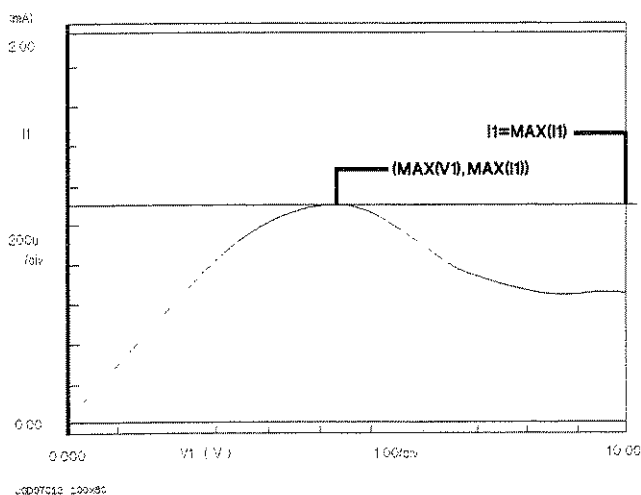

If you want to automatically draw a normal mode line between the following two points:

- point where X value is same as maximum V1, and Y value is same as maximum I1
- maximum I1 point on measurement curve

then specify the following on the DISPLAY: ANALYSIS SETUP page:

```
LINE1: [NORMAL ] line on [Y1] between a point [AT]  
X: [MAX(V1)]  
Y: [MAX(I1)]  
and a point [WHERE]  
[I1]=[MAX(I1)]
```

Data Variable and Analysis Function
Analysis Function

If You Have A Problem

This chapter explains how to solve a problem or how to read status and error codes, if you encounter some problem.

This chapter is organized into the following sections:

- When you make a measurement
 - This section explains how to solve the problems that may occur when making a measurement.
- If errors occur
 - This section lists error codes and messages that may be displayed when operating Agilent 4155B/4156B. Also, this section describes how to read data status.

NOTE

To Get Help Information

To start help function, press the Help front-panel key. Then, you can select one of the following primary softkeys.

- **OVERVIEW**
Briefly explains each help softkey.
- **PAGE MAP**
Shows a map of all screens, highlights the present screen name, and gives a brief description of the highlighted screen name. You can use the arrow keys to highlight another screen name, then can display the screen by selecting the SELECT secondary softkey.
- **FIELD INFO**
Describes field where the pointer is located on the screen, how to setup the field, and the setting restrictions. This softkey is not displayed for GRAPHICS, LIST, KNOB SWEEP, or STRESS FORCE screen.
- **DATA STAT**
Shows how to read data status, which is displayed at the bottom of GRAPHICS, LIST, KNOB SWEEP, or STRESS FORCE screen. This softkey is displayed only for these screens.
- **INPUT AID**
Displays variable names, mathematics functions, and read-out functions, and describes the highlighted name or function. This softkey is not displayed for GRAPHICS, LIST, KNOB SWEEP, or STRESS FORCE screen.

You can enter desired variable or function into the selected setup field of a screen by selecting ENTER secondary softkey, then pressing Enter front-panel key.

If You Have A Problem
When You Make A Measurement

When You Make A Measurement

This section covers the following basic problems that you may encounter when you making a measurement, and the solutions.

- “If Measured Value Oscillates when Measuring High-Frequency Devices”
- “If Measured Value Oscillates when Measuring Negative Resistance”
- “If Noise Affects the Measured Values”
- “If Measured Voltage has some Error when Forcing a Large Current”
- “If Large Current Causes High Temperature (Thermal Drift)”
- “If Measurement Takes More Time than Specified”
- “If Measurement Damages the Device under Test”
- “If You Get Unexpected Data when Performing Sampling Measurement”

If You Have A Problem
When You Make A Measurement

If Measured Value Oscillates when Measuring High-Frequency Devices

When measuring parameters of high-frequency devices, such as GaAs MESFETs or high-frequency bipolar transistors, oscillation may cause measurement problems. Normal measurement cannot be performed because of oscillation.

To solve this problem:

- For FETs, add resistive ferrite beads as close as possible to the gate.
- For bipolar transistors, add resistive ferrite beads as close as possible to the base or emitter.
- Make connection cables as short as possible. Long wires cause oscillation because of their large inductance.

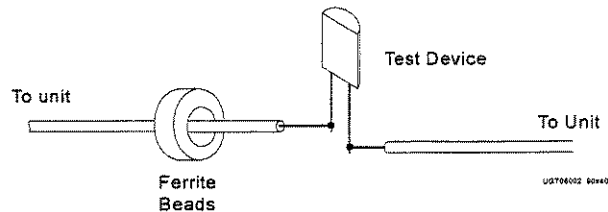

If You Have A Problem
When You Make A Measurement

If Measured Value Oscillates when Measuring Negative Resistance

If the DUT has negative resistance characteristics, SMUs may oscillate. Because SMUs operate as negative feedback amplifier.

To solve this problem:

- For voltage controlled negative resistance device
 - Connect G in parallel with your DUT to cancel negative resistance. To obtain an output I-V curve, use the following equation.

$$I_Y = I - G * V$$

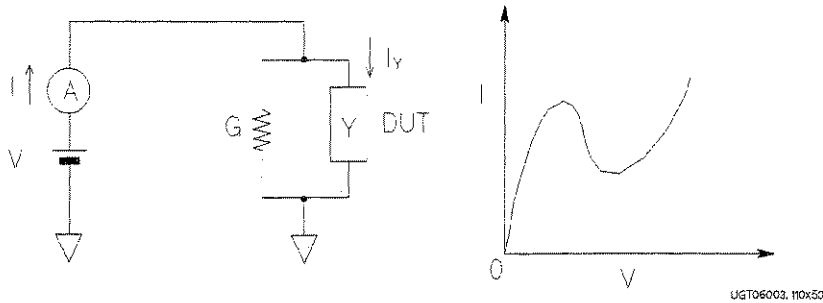

- For current controlled negative resistance device
 - Connect R in series with your DUT to cancel negative resistance. To obtain an output I-V curve, use the following equation.

$$V_Z = V - R * I$$

- If the resistance of the DUT is less than 1 MΩ, you can use R-Box.

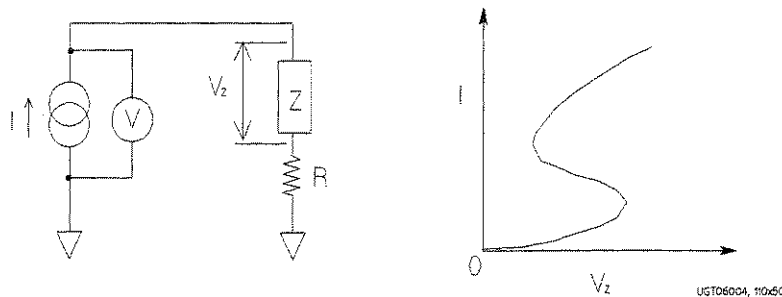

If Noise Affects the Measured Values

When you measure low current of a DUT, the measured values may not be stable.

To solve this problem:

- Use guarding to reduce the leakage current between your prober and the 4155B/4156B. Note that long wires cause oscillation because of their large inductance. For details about connections, refer to “To Make Connections to Reduce Leakage Current” in Chapter 4.
- If some high-power electric machines are operating around the 4155B/4156B, turn off the machines, then perform the measurements. The machines affect the power line waveform.
- Shut the lid of test fixture or shield box to prevent effects of light.
- If these are vibrations due to nearby machines or due to air flow, put cushioning material under prober, cable, and the 4155B/4156B; install stabilizer on the prober; and make the cables stable by taping.
- Wait several minutes after connecting cables or moving probe needles. Because these operations cause electromotive force.
- If you use only Force terminal and triaxial cables for HRSMUs or HPSMU, connect an open cap to sense terminal.
- Keep constant temperature in the room when you use the 4155B/4156B. Shift of 1 °C may shift the measurement values. Temperature change causes the following.
 - Offset current in the 4155B/4156B.
 - Thermoelectromotive force in DUT, which causes low current.
 - Expansion and contraction of cables, which causes noise.

If You Have A Problem
When You Make A Measurement

If Measured Voltage has some Error when Forcing a Large Current

Voltage measurement may have some error because of the effects of the cable resistance when forcing a large current.

To solve this problem:

- Use Kelvin connections between SMUs and DUT. To cancel the effects of cable resistance, connect the sense line as close as possible to the terminal of the DUT.

For details of Kelvin connections, see “Connection to Device Under Test (DUT)” in Chapter 4

If Large Current Causes High Temperature (Thermal Drift)

If a large current is forced to a DUT, the temperature of the DUT may increase, which may cause characteristics to drift.

To solve this problem:

- Use the pulse output mode of the SMU.

For large currents, the SMU should be set to pulse output mode. This decreases the average power output to prevent temperature rise of DUT.

If You Have A Problem
When You Make A Measurement

If Measurement Takes More Time than Specified

When measuring current that is 10 μA or less, SMUs may take longer time to measure than the specified integration time. When measuring in a low current range, the SMUs automatically take longer integration time to perform accurate and stable measurements.

To solve this problem:

- Measure current using a fixed range that is more than 10 μA . The measurement will be performed in the specified integration time.

If you set many measurement channels, measurement takes a longer time.

To solve this problem:

- Decrease measurement channels to reduce measurement time.

Note that the number of measurement channels automatically increases if you do *both* the following: force voltage from channels that are connected to R-Box *and* display the voltage values or use voltage values in user functions. The channels automatically measure current, which is used to compensate the voltage values.

If You Have A Problem
When You Make A Measurement

If Measurement Damages the Device under Test

When Using SMU

When performing breakdown measurements by using SMU, DUTs may be damaged.

When voltage is forced from an SMU, the current is limited by the compliance setting, which prevents the DUT from being damaged by a large current. But when the current rapidly increases, the current limiter in the SMU cannot follow the rapid current increase, so a large amount of current may flow through the DUT for a moment, which may damage the DUT.

To solve this problem:

- Insert a protecting resistor as close as possible to DUT. You can also use a resistor of Agilent 16441A R-Box.

When Using VMU

When using VMU, the measurement terminal voltage increased by charge of buffer amplifier current in VMU, may damage DUT.

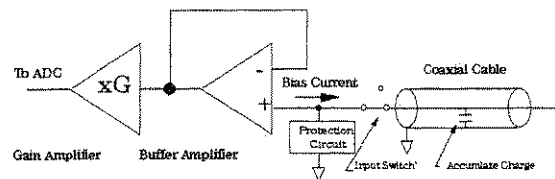

When the measurement terminal of VMU is open and when a coaxial cable is connected to VMU, buffer amplifier current charges increase the VMU terminal voltage. After a long time charge, the increased terminal voltage is discharged by connecting DUT, which may damage the DUT.

To solve this problem:

There are three ways to prevent this problem as follows:

If You Have A Problem When You Make A Measurement

1. Insert a large resistor between VMU and common

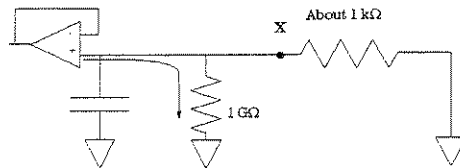

This method cannot be used for voltage measurement of high resistance. Because the VMU input impedance gets lower.

2. Use SMUs instead of VMUs

This method degrades measurement accuracy and resolution than VMU due to each unit's specification difference.

3. Insert a resistor in series to device

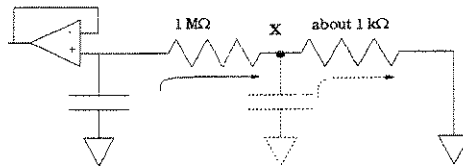

This method needs to

- select an appropriate resistor value for each device resistance value.
- set wait time before measurement until charge current settles.
- insert the resistor at close point to DUT to prevent damage due to the charge in a measurement circuit. (See dotted line in the above figure)

If You Have A Problem
When You Make A Measurement

If You Get Unexpected Data when Performing Sampling Measurement

If initial interval is set to a short time and if FILTER ON is set, you may get unwanted data. FILTER ON causes a slower rise time, so short initial interval will sample during this rise time.

To solve this problem:

- Set FILTER field to OFF if you set initial interval to a short time.

Some data may be skipped because measurement takes a long time. Measurement takes a long time if measurement is performed in a low current range, if many measurement channels are set up, or if analysis, such as moving a marker, is performed during measurements.

To solve this problem:

- Measure current using a fixed range that is more than 10 μA . For measurement ranges 10 μA or less, measurement takes longer than the specified integration time.
- Decrease measurement channels to reduce measurement time.

Note that the number of measurement channels automatically increases if you do *both* the following: force voltage from channels that are connected to R-Box *and* display the voltage values or use voltage values in user functions. The channels automatically measure current, which is used to compensate the voltage values.

- Do not perform analysis operation during measurement state

If Errors Occur

If the 4155B/4156B is not operated correctly, or if diagnostics or calibration fails, error codes and error messages are displayed.

If measurement or forcing stress are not performed correctly, measurement data status is displayed at bottom of GRAPHICS, LIST, KNOB SWEEP, or STRESS FORCE screen.

This section describes the following:

- “If Errors Occur when You Perform Self-calibration or Diagnostics”
- “If Errors Occur when You Operate the 4155B/4156B”
- “If a Measurement Data Status is Displayed”

If You Have A Problem

If Errors Occur

If Errors Occur when You Perform Self-calibration or Diagnostics

The following are the error codes that are displayed at the bottom of the SYSTEM: SELF-CALIBRATION/DIAGNOSTICS screen if errors occur when you perform self-calibration or diagnostics.

If errors occur, write down the displayed error codes and contact the nearest Agilent Technologies Sales and Service office. Up to seven error codes can be displayed at the bottom of the SYSTEM: SELF-CALIBRATION/DIAGNOSTICS screen. To display the error codes, move pointer to a desired test item.

Error codes for measurement unit

The following are the error codes for measurement units. Error codes are 5-digit numbers.

1xyyy

- xx: measurement unit
 - 00: VSU1,2 and VMU1,2
 - 01 to 06: SMU1 to SMU6
 - 07: PGU1,2
 - 08: GNDU
 - 09: AD converter
- yy: error number

1xx05 AD converter failed ROM or RAM self-test. Measurement unit failed AD converter test as a pretest for calibration or self-test.

1xx06 Successive approximation AD converter failed. Measurement unit failed AD converter test as a pretest for calibration or self-test.

1xx07 Integrating type AD converter failed. Measurement unit failed AD converter test as a pretest for calibration or self-test.

1xx08 AD converter test reached timeout. Measurement unit failed AD converter test as a pretest for calibration or self-test.

1xx11 Overvoltage occurred for a measurement unit.

1xx12 Overcurrent occurred for a measurement unit.

If You Have A Problem
If Errors Occur

- 1xx15** Measurement units that are not supported are detected.
- 1xx19** Emergency occurred but the cause is unknown. This is displayed, for example, when unit is known but cause is unknown.
- 1xx90** AD converter test reached timeout during calibration or self-test for a measurement unit.
- 1xx91** FIFO (first-in, first-out) for AD converter overflowed because SMU controller takes long time to read measurement data.
- 1xx92** Calibration or diagnostics was aborted by an emergency or *RST command.
- 1xx94** The 4155B/4156B was turned on before the 41501A/B.
- 1xx97** Communication failed between HOST controller and SMU controller. Or calibration/diagnostics was performed, but HOST controller couldn't receive the result from SMU controller.
- 10030** VSUs and VMUs failed default test of calibration.
- 10031** VSUs and VMUs failed function check.
- 10032** VSUs failed gain or offset calibration.
- 10033** VMUs failed gain or offset calibration.
- 10034** VMUs failed differential mode 2 V range gain or offset calibration.
- 10035** VSUs failed gain and offset calibration, VMUs failed gain and offset calibration, or VMU failed differential mode 2 V range gain and offset calibration.
- 10036** VMUs failed differential mode 0.2 V range gain or offset measurement.
- 10037** VMUs failed differential mode 0.2 V range gain and offset calibration.
- 10038** VMUs and VSUs failed CMR (Common Mode Rejection) amp adjustment.
- 10040** VSU1 and VMU1 failed ± 20 V measurement self-test in 20 V range.
- 10041** VSU2 and VMU2 failed ± 20 V measurement self-test in 20 V range.
- 10042** VSU1 and VMU2 failed ± 20 V measurement self-test in 20 V range.
- 10043** VMU2 and VMU1 failed ± 20 V measurement self-test in 20 V range.
- 10044** VSU1 and VMU1 failed ± 2 V measurement self-test in 2 V range.
- 10045** VSU2 and VMU2 failed ± 2 V measurement self-test in 2 V range.

If You Have A Problem
If Errors Occur

- 10046 VSU1 and VMU2 failed ± 2 V measurement self-test in 2 V range.
- 10047 VSU2 and VMU1 failed ± 2 V measurement self-test in 2 V range.
- 10048 VMUs and VSUs failed differential 2 V range self-test. This test measures ± 2 V by VMUs in differential mode. (VSU1 is connected to VMU1, and VSU2 is connected to VMU2. VSU1 forces 0 V. VSU2 forces 2 V).
- 10049 VMUs and VSUs failed differential 2 V range self-test. This test measures 0 V by VMUs in differential mode. (VSU1 is connected to VMU1, and VSU2 is connected to VMU2. VSU1 forces 0 V.)
- 10050 VMUs and VSUs failed differential 0.2 V range self-test. This test measures 0 V by VMUs in differential mode. (VSU1 is connected to VMU1, and VSU2 is connected to VMU2. VSU1 forces 0 V.)
- 10051 VMUs and VSUs failed differential 2 V range self-test. This test measures 0 V by VMUs in differential mode. (VSU2 is connected to VMU1 and 2, and forces 0 V.)
- 10052 VMUs and VSUs failed differential 0.2 V range self-test. This test measures 0 V by VMUs in differential mode. (VSU2 is connected to VMU1 and 2, and forces 0 V.)
- 10x20 SMU failed function check.
- 10x21 SMU failed CMR (Common Mode Rejection) amp calibration.
- 10x22 SMU failed oscillation detector test.
- 10x23 SMU failed V set and V measure calibration.
- 10x24 SMU failed I set and I measure calibration.
- 10x25 SMU failed I bias test.
- 10x26 SMU failed V switch test.
- 10760 PGU1 failed pulse gain calibration.
- 10761 PGU2 failed pulse gain calibration.
- 10762 PGU1 failed pulse offset calibration.
- 10763 PGU2 failed pulse offset calibration.
- 10764 PGU1 failed voltage calibration of base value.
- 10765 PGU2 failed voltage calibration of base value.
- 10766 PGU1 failed leading time calibration.

If You Have A Problem
If Errors Occur

- 10767** PGU2 failed leading time calibration.
- 10768** PGU1 failed trailing time calibration.
- 10769** PGU2 failed trailing time calibration.
- 10770** PGU1 failed slope offset calibration.
- 10771** PGU2 failed slope offset calibration.
- 10772** PGU1 failed slope sampling calibration.
- 10773** PGU2 failed slope sampling calibration.
- 10875** GNDU failed offset calibration.
- 10905** AD converter failed ROM or RAM self-test.
- 10906** Successive approximation AD converter failed calibration or self-test.
- 10907** Integrating type AD converter failed calibration or self-test.
- 10908** AD converter reached timeout. AD converter did not return completion status within certain time after sending calibration or self-test command.

If You Have A Problem
If Errors Occur

Error code for CPU and peripherals

The following are the error codes for CPU and peripherals. Error codes are 5-digit numbers.

2wwwz

- *www*: test item number (on SYSTEM: SELF-CALIBRATION/DIAGNOSTICS screen).
- *z*: test number

23010	Host DRAM failed self-test.
23021	Host ROM failed checksum test.
23022	Host SRAM failed read and write test.
23023	EEPROM failed read and write test.
23030	Real-time clock failed timer test.
23040	GPIB controller failed self-test. This test sets some settings, then checks the status.
23050	Parallel interface controller failed self-test. This test sets some settings, then checks the status.
23061	Host controller sends a command and does not receive acknowledge from SMU controller.
23062	Host controller failed receiving response from SMU controller by sending a command.
23071	SMU controller ROM failed checksum test.
23072	SMU controller on-board SRAM failed read and write test.
23073	SMU controller internal SRAM failed read and write test.
23074	SMU controller internal timer failed self-test.
23075	SMU controller timer does not operate with correct frequency.
23076	SMU controller failed power on self-test.
23077	SMU controller test gets timeout.
23080	Access to graphics system processor failed read and write test.
23091	Graphic memories (SRAM) failed read and write test.

If You Have A Problem
If Errors Occur

23092	Graphic memories (VRAM) failed read and write test.
24017	Parallel interface failed data line test.
24018	Parallel interface failed control line test.
24021	Trigger output test failed or reached timeout.
24022	Trigger input test failed.
24041	Flexible disk drive controller test failed.
24042	Flexible disk drive 5 V power line test failed.
24051	Flexible disk drive failed diskette change test.
24052	Flexible disk drive failed read and write test.
24062	12 V source on post regulator is not output.
24063	15 V source on post regulator is not output.
24064	3 V source on post regulator is not output.
24065	LAN interface test failed.
24071	A front-panel key is stuck in pressed position.
24072	Front key assembly may be disconnected.
24073	Front-panel key controller is not functioning properly.
24100	External key controller failed self-test.
24120	Selector test reached timeout.
24130	R-Box test reached timeout.

If You Have A Problem

If Errors Occur

If Errors Occur when You Operate the 4155B/4156B

The following error codes and messages can occur when operating the 4155B/4156B. The error codes and messages are displayed in a message window or in the message display area at the bottom of the screen.

- | | |
|----|---|
| 1 | Syntax error. Input should be integer number. |
| 3 | Syntax error. Input should be real number. |
| 4 | Syntax error. Unrecognized parameter. |
| 5 | Illegal setup. The parameter is out of range. |
| 6 | DATA buffer full. Too many APPEND. |
| 7 | DATA buffer full. Too many points. |
| 8 | Cannot define more than 6 User Vars. |
| 9 | Syntax error. First char should be Alphabet. |
| 10 | Syntax error. Must be alphanumeric. |
| 11 | Name must be set for user function/variable.
Name setup cannot be omitted when setting a user function or a user variable name. |
| 12 | Syntax error. Unknown variable name. |
| 13 | System error. HOSTC received invalid data.
The 4155B/4156B may be broken. Contact the nearest Agilent Technologies Sales and Service office. |
| 14 | System error. Unable to communicate with SMUC.
The 4155B/4156B may be broken. Contact the nearest Agilent Technologies Sales and Service office. |
| 15 | System error. Illegal command to SMUC.
The 4155B/4156B may be broken. Contact the nearest Agilent Technologies Sales and Service office. |
| 16 | Illegal operation. Too many LIST data. |
| 17 | Unable to display data list. Not enough memory. |

If You Have A Problem
If Errors Occur

- 18** Device I/O error. Unable to print out.
The 4155B/4156B, printer, or plotter may be broken. Contact the nearest Agilent Technologies sales and service office.
- 19** Filer error. File name is required.
- 20** Filer error. File Type is required.
- 21** System error. Realtime clock has problem.
The 4155B/4156B may be broken. Contact the nearest Agilent Technologies Sales and Service office.
- 22** Not 4155/4156 file.
- 23** File was created by old revision.
- 24** File may be corrupt.
- 25** Zero offset meas failed for <unit name>.
Offset value is too large, so Zero offset measurement is aborted.
- 26** Too big offset for 10 pA Range of <unit name>.
Offset value is too large, so offset cannot be canceled perfectly.
- 27** System busy. Measuring.
- 28** System busy. Forcing stress.
- 29** System error. EEPROM write error.
The 4155B/4156B may be broken. Contact the nearest Agilent Technologies Sales and Service office.
- 30** Fixture open. Measurement aborted.
- 31** Auto calibration was aborted.
- 32** Auto calibration failed.
- 33** No data in internal memory.
- 34** Illegal data. File may be corrupt.
- 35** System busy. Unable to save/get when MEAS/STR.
- 36** System busy. Unable to change Y-axis.
- 37** System error. SMUC lost data.
The 4155B/4156B may be broken. Contact the nearest Agilent Technologies Sales and Service office.

If You Have A Problem
If Errors Occur

- 38 Buffer overflowed. Aborted.
- 39 Syntax error. Undisplayable character.
- 40 Illegal setup. One unit assigned several CH.
- 41 Illegal disk. Revision mismatch.
- 42 Read error occurred.
- 43 File name is not LIF type.
- 44 File name is not DOS type.
- 45 File name is not LIF/DOS type.
- 46 Volume label is not LIF type.
- 47 Volume label is not DOS type.
- 48 Incorrect memory number.
- 49 Source and Target are same.
- 50 Unable to copy. Memory full.
- 51 Unable to copy. SRC and TGT mem num is same.
You cannot specify same memory number in both SOURCE and TARGET name fields.
- 52 Illegal suffix.
- 53 System busy. Emergency handling.
- 54 System busy. Measuring.
- 55 System busy. Executing cal/diag.
- 56 System busy. Executing auto calibration.
- 57 System busy. Printing out hard copy.
- 58 Unable to copy 4145 data file to memory.
- 59 Unable to graph plot. Recover error state.
Unable to print out or plot out when error message is displayed.
- 60 Cal/diag must be performed in the idle state.
Calibration and Diagnostics cannot be performed unless the 4155B/4156B is in the idle state. For example, this error is displayed if the SCPI calibration command is sent when the 4155B/4156B is not in the idle state.

If You Have A Problem
If Errors Occur

- 61** ADC time out.
The AD converter has caused a time out. Perform 109: ADC test on the SYSTEM: SELF-CALIBRATION/DIAGNOSTICS screen. If this test fails, the 4155B/4156B may need service. Contact the nearest Agilent Technologies Sales and Service office.
- 62** ADC FIFO overflow.
The AD converter has caused a FIFO overflow. A data transfer error occurred between the AD converter and the SMUC. The 4155B/4156B may need service. Contact the nearest Agilent Technologies Sales and Service office.
- 63** SMUC failed to send data to HOSTC.
The SMU controller failed to send data to the host controller. Retry the measurement. If this error is still displayed, recycle the power by turning the instrument off and then on again.
- 64** TIFF format supports SCREEN DUMP only.
The TIFF format is only supported by the SCREEN DUMP function.
- 65** TIFF image can only be written to a FILE.
A TIFF image can only be written to a FILE. The 4155B/4156B cannot output TIFF format images to a printer or plotter.
- 66** HR TIFF format supports DUMP and GRAPH PLOT.
A high resolution TIFF image is only supported by the DUMP and GRAPH PLOT functions.
- 67** HR TIFF image can only be written to a FILE.
A high resolution TIFF image can only be written to a FILE.
- 100** VAR1 is not assigned.
- 101** VAR1 assigned to multiple Channels.
- 102** VAR2 assigned to multiple Channels
- 103** VAR1' assigned to multiple Channels.
- 104** VAR1 and VAR1' must be same MODE.
- 105** Cannot set multiple SMUs to pulse mode
- 106** Cannot use VAR when SAMPLING.
- 107** Cannot use SMU pulse when SAMPLING.

If You Have A Problem
If Errors Occur

- 108 Duplicate variable names exist.
- 109 The setup is not finished.
- 110 Standby chan cannot use R-BOX resistor
For standby channel, you cannot use R-Box resistor.
- 111 Common chan cannot use R-BOX resistor.
For common mode channel, you cannot use R-Box resistor.
- 112 VAR1 step number is out of range.
- 113 START and STOP have different sign.
- 115 SMU pulse Period must be \geq Width+4ms.
- 116 VAR1 output power too large for unit.
- 117 VAR1' output power too large for unit.
- 118 VAR2 output power too large for unit.
- 119 TOT SMP TM=AUTO is for LINEAR only.
AUTO can be specified for total sampling time *only when* LINEAR sampling mode is selected.
- 120 Only LINEAR when init int \leq 480 us.
When initial interval is set to 480 μ s or less, you *cannot* specify LOG or THINNED-OUT sampling mode.
- 121 For LINEAR set AUTO if init int \leq 480us
When initial interval is set to 480 μ s or less *and* when LINEAR sampling mode is set, AUTO must be set in TOTAL SAMP. TIME field.
- 122 TOT SP TM must be \geq INIT INT(NOofSMP-1)
Total sampling time must be set in the following range:
total sampling time \geq initial interval \times (number of samples -1)
- 123 STOP CONDITION NAME is not set.
- 124 PGU pulse Period must be $>$ Width.
- 125 PGU pulse Period must be \geq Delay.

If You Have A Problem
If Errors Occur

- 126 PG leading/trailing must be same range
PGU leading and trailing time must be set in the same range. For details about the ranges, see Chapter 1 in this manual.
- 127 PGU Leading must be $\leq 0.8 \times \text{WIDTH}$.
Leading time must satisfy the following equation.
 $\text{leading time} \leq \text{pulse width} \times 0.8$
- 128 PGU Trailing must be $\leq 0.8 \times (\text{Peri-Wid})$.
Trailing time must satisfy the following equation.
 $\text{trailing time} \leq (\text{pulse period} - \text{pulse width}) \times 0.8$
- 129 SMU I range must be \leq Compliance range.
- 130 SYNC channel is not assigned.
At least one SYNC channel must be specified.
- 131 Assigned more than 4 SYNC channels.
- 132 Set INIT INT ≥ 2 ms for multi-CH MEAS.
When you perform multi-channel measurements, initial interval must be 2 ms or more.
- 133 Use FIXED range when INIT INT < 2 ms.
When you use auto ranging or limited auto ranging measurement, you must set initial interval to 2 ms or more.
- 134 Cannot disable STBY-ON ch in stress.
On STRESS: CHANNEL DEFINITION screen, you cannot disable (delete entries in row) channels that are set to STBY ON on the CHANNELS: CHANNEL DEFINITION screen.
- 135 Undefined symbol in user function.
- 136 Syntax error in user function.
- 137 Too few arguments in user function.
- 138 Too many arguments in user function.
- 139 User function area is full.
- 140 Recursive call in user function.
- 141 User function is undefined.
- 142 Stack overflow in user function.

If You Have A Problem
If Errors Occur

- 143 COMMON channel FCTN must be CONST.
- 144 COMMON channel FCTN must be NSYNC.
- 145 System busy. Unable to change page when MEAS.
- 146 System busy. Unable to change page when STRS.
- 147 Ineffective page in this setup.
- 148 X axis is not assigned.
- 149 Y1 axis is not assigned.
- 150 ENABLE DELAY must be $\leq 32767 \times \text{INIT INT}$
For sampling measurements, when stop condition is set to ENABLE,
enable delay must be *initial interval* $\times 32767$ or less.
- 151 No unit is set to STANDBY ON.
- 152 System busy. MEASURING (or 4145 USER MODE).
- 153 MIN, MAX have different sign in LOG.
- 154 Can do such operation only for USER VAR.
- 155 Illegal setup. The name was already used.
- 156 User variable is used in user function.
If a user variable is used in user functions, the user variable cannot be deleted.
- 157 AUTO Analysis is undefined.
- 158 TOT SAMP TIME must be $\leq \text{INIT INT} \times 32767$.
Total sampling time must be *initial interval* $\times 32767$ or less and
 1×10^{11} or less.
- 159 Measure channel is not assigned.
- 160 Unable to find approximate data.
- 161 Illegal graph scale setup.
- 163 The Sweep/Pulse Polarity is not same.
- 164 SYNC can not be set for standby CH.

If You Have A Problem
If Errors Occur

- 165** Set value is too small for range.
For LOG sweep measurement, start and stop value must be equal or more than setup resolution. For sweep measurement, step value of VAR1 and VAR2 must be equal or more than setup resolution.
- 166** PGU Peak/Base difference must be $\leq 40V$
- 170** Use Sweep/Bias instead of SMU Pulse.
- 171** Knob Sweep sets VAR1' to CONST.
If you set VAR1' for knob sweep measurement, the VAR1' channel forces a constant value equal to START value. VAR1' cannot be a sweep source for Knob Sweep measurement.
- 172** Cannot do SAMPLING when Knob Sweep.
- 173** |STEP| must be \leq |STOP-START|.
- 174** Cannot set CONT AT ANY if PCOMP is ON.
When you set power compliance, you cannot select CONT AT ANY secondary softkey.
- 175** CONST setup must be \leq unit output range.
- 176** Pulse BASE must be \leq unit output range.
- 177** PGU pulse WIDTH must be \geq setup res.
Pulse width of PGUs must be greater than or equal to unit setup resolution.
- 178** TRIG OUT DELAY is too long.
Trigger out delay must be 32.7 ms or pulse width you specified, whichever is shorter.
- 179** Cannot ENABLE stop if INIT INT < 2 ms.
When initial interval is set to less than 2 ms, you cannot set stop condition.
- 180** Illegal setup. Target module is not installed.
- 181** Illegal setup. Invalid command.
- 182** Cannot define more than 6 User functions.
- 183** Cannot define more than 8 data vars in lists.
- 184** Cannot define more than 2 display data vars.

If You Have A Problem
If Errors Occur

- 185 ASCII format does not allow block transfer.
- 186 Block size mismatched with data format.
- 187 Y2 axis is not assigned.
- 188 List name is not assigned.
- 189 The specified name is not list name.
- 190 Illegal file type is requested.
- 191 System busy. Printing out hard copy.
- 192 Unable to set. Another controller is on bus.
- 193 Unable to specify this name here.
- 194 PGU Pulse DELAY must be \geq setup res.
PGU pulse delay time must be \geq setup resolution.
- 195 Cal/Diag failed. Cannot use unit.
- 196 Compliance too low to force pulse.
- 197 Compliance too high to force pulse.
- 198 Two VPULSE PGUs must be same STBY.
- 199 Two VPULSE PGUs must be same FCTN.
- 200 Improper parameter for file operation.
An option for the file system command has been set up incorrectly.
- 201 System error. Filer memory overflow.
- 202 Filer error. Integer overflow.
- 203 Bad volume specifier.
Volume label for mass storage is incorrect. Initialization may have been performed on an incompatible system, or the disk may be defective.
- 204 Filer error. File type is wrong.
- 205 Filer error. EOF found.
- 206 Filer error. EOR found.
- 207 File error. Illegal DISK parameter.
Illegal disk parameter was detected. The mass storage device is set up incorrectly.

If You Have A Problem
If Errors Occur

- 208** System error. Controller not found.
Unable to access the file system. The file system controller cannot be found. The 4155B/4156B may need service. Contact the nearest Agilent Technologies Sales and Service office.
- 210** File error. Unable to execute. File open.
Unable to perform the requested file operation. The file is already open. Close the file and retry the operation.
- 211** Unable to operate the device. File is open.
Unable to perform the requested file operation on the specified device because the device has a file open.
- 212** File error. DISK or DISK drive may be broken.
DISK or DISK drive hardware may be in need of service.
- 213** Filer error. DISK record is not found.
- 214** File error. DISK record address error.
Unable to find record because the mass storage device has a problem.
- 215** Filer error. DISK record data error.
- 216** File error. DISK system error.
The hardware or the device are causing a problem.
- 217** File error. Bad volume label.
The mass storage has an incorrect volume label. Verify the volume number is set correctly.
- 218** System error. No interface found.
The network interface was not found because of a wrong select code setup. Verify the select code is set correctly.
- 219** File error. Device timeout.
Time-out occurred on the device.
- 220** Filer error. Undefined I/O path.
- 221** Filer error. Permission denied.
- 222** File error. Too many files open.
Unable to open multiple files at the same time. Close the file that is currently open before opening a second file.

If You Have A Problem

If Errors Occur

- 223 Unable to PURGE the file or directory.
Unable to purge the file or the directory, for example, permission denied.
- 224 Filer error. The directory is not empty.
- 225 Filer error. No DISK in the drive.
- 226 Filer error. Initialization failed.
- 227 Filer error. Invalid DISK volume label.
- 228 File error. DISK volume label is undefined.
Volume label is undefined or was not found. Verify the volume number is set correctly.
- 229 Filer error. DISK is not initialized.
- 230 Filer error. Checkread error.
- 231 Filer error. Bad HFS DISK.
- 232 Filer error. DISK is full.
- 233 Filer error. Directory is full.
- 234 Filer error. File name is undefined.
- 235 Filer error. File name is wrong.
- 236 Filer error. The file name is already used.
- 237 Filer error. Bad device type.
- 238 Filer error. Unable to use wildcard.
- 239 Filer error. Operations failed.
- 241 Filer error. The target type is wrong.
- 242 Filer error. The file is protected.
- 243 Filer error. DISK is protected.
- 244 System error. Unable to verify.
- 245 Filer error. Unable to copy between LIF/DOS.
- 246 Filer error. Reason Unknown.
- 265 HOLD TM must be ≥ 0 when INIT INT ≥ 2 ms.
- 280 VAR1' output value is out of range.

If You Have A Problem
If Errors Occur

- 282** Set INIT INT > 640 us for THINNED-OUT.
When you perform thinned-out sampling measurements, the initial interval must be more than 640 μ s.
- 284** Sampling range must be \leq 11decades.
- 286** Cannot execute cal/diag after power fail.
Turn on the 4155B/4156B again to perform calibration or diagnostics.
- 288** MEAS not finished. Incomplete data deleted.
If you press Stop front-panel key before the specified measurement finishes, incomplete measurement data is deleted.
- 289** STBY ON ch MODE (MEAS/STR) must be same
- 290** Cannot use unit after power fail.
- 292** VAR1' parameters must be \geq output res
Start, stop, and step value of VAR1' channel must be unit output resolution or more.
- 293** Cal/Diag aborted (failed on some units).
Calibration or diagnostics was aborted by receiving *RST command. So, some units maybe failed.
- 300** Over voltage is detected.
- 301** Over Current is detected.
- 302** Power failure at Main Frame.
Turn on the 4155B/4156B again. You can use filer functions after selecting OK secondary softkey (except when this error occurs during power-on test).
- 303** Power failure at Expander Box.
Turn on the 4155B/4156B again. You can use filer functions after selecting OK secondary softkey (except when this error occurs during power-on test).
- 305** Cannot shutdown Main Frame.
- 306** Emergency. Reason unknown.
An emergency occurred on an empty slot. Or an emergency occurred on an existing slot, but the reason is unspecified.

If You Have A Problem
If Errors Occur

- 307** Cannot shutdown Power Supply.
Turn on the 4155B/4156B again. You can use filer functions after selecting OK secondary softkey (except when this error occurs during power-on test).
- 308** Unknown emergency (SMUC time out).
Perform 305: HOSTC <--> SMUC I/F test on the SYSTEM: SELF-CALIBRATION/DIAGNOSTICS screen. If this test fails, the 4155B/4156B may need service. Contact the nearest Agilent Technologies Sales and Service office.
- 309** The SMU AND PULSE GENERATOR EXPANDER is not turned on.
Turn on the expander, then cycle mainframe power.
- 310** Unsupported unit detected in Slot ##. Turn off the power and remove the unit.
The displayed unit must be changed. Contact the nearest Agilent Technologies Sales and Service office.
- 320** Not enough memory. Cannot display >=200 files.
The 4155B/4156B cannot display more than 199 files on the FILE CATALOG because of an internal memory limitation. If you create more than 199 files, move the additional files to another directory.
- 321** Too many links.
The file has too many links. Remove extra links or use symbolic links.
- 322** File system down or network disconnected.
Unable to access the network directory. The file system was down or the network was disconnected.
- 323** The network address is already used.
A process has already been bound to the address. The current process must finish before the new process can use the address.
- 324** Change dir failed. File is not a directory.
Change directory failed because you specified a file, not a directory.
- 325** Unable to open file. Deadlock occurred.
Unable to open the file. Deadlock occurred in the resource where you tried to open the file.

If You Have A Problem
If Errors Occur

- 326** Device not present. Unsupported file type.
Device or driver was not found to open the file. Unable to open file because the file type is not supported.
- 327** Interrupted system call.
The lpr driver received a signal from the system, that interrupted the data transfer from the lpr driver.
- 328** lpd time out occurred. Try again ?
A time out occurred when trying to connect to the lpd server because the lpd server did not respond.
- 329** lpd print server cannot be recognized.
Unable to recognize the lpd print server. Verify the address setup or setup syntax is correct.
- 330** lpd server connection failed or was denied.
The lpd server connection failed, or was denied, because the lpd server was already connected or the server was blocked.
- 331** lpr data transfer failed.
Data transfer from the lpr server failed because lpr data communication was disconnected. Verify the network is working properly and check to see if the server is up.
- 332** Unable to print out. Not enough device space.
Unable to print out because the device connection failed. There is not enough available space in the buffer for the communication.
- 334** lpr failed data transfer. Data size mismatch.
Unable to print out because the lpr server failed data transfer. The size of the data was not the expected size.
- 335** lpr Network interface is down. Try again ?
The network interface cannot be found because the network interface for the lpr server is down.
- 336** Unable to print out. Reason unknown.
Network connection failed. The reason for the failure is unknown.

If You Have A Problem
If Errors Occur

- 337 Cannot set 0.0.0.0 for 4155/4156 IP address.
When a valid host name for the 4155B/4156B network setup is specified, the IP address of the 4155B/4156B cannot be set to 0.0.0.0.
- 338 Cannot set 0(zero) for 4155/4156 User ID.
When a valid host name for the 4155B/4156B network setup is specified, the User Id of the 4155B/4156B cannot be set to 0 (zero).
- 339 No response from NFS. Try again ?
There is no response from the Network File System (NFS) when trying to mount a network disk. Verify the network is operating properly and the file export executed properly.
- 340 Host name must be <= 15 alphanumeric character.
The 4155B/4156B host name must be 15 or less alphanumeric characters.
- 344 System busy. Cannot execute US/US42 command.
Unable to move to FLEX command control mode, because the US or US42 command cannot be executed while system is busy; making measurement, operating file functions, executing calibration or diagnostics, printing, emergency, and so on.
- 345 Change display page. DISP OFF(0) is not allowed.
Unable to enter the :DISP OFF (or 0) command when the 4155B/4156B screen displays System screen group or KNOB SWEEP screen.
- 346 Enter DISP ON(1) to execute this command.
Unable to enter the :PAGE:KSW command group,
:PAGE:SCON:KSW command, or :DIAG:TEST *test_no* (*test_no*: 201 to 413) command when the 4155B/4156B screen is set to the update *disable* state by the :DISP OFF (or 0) command.
- 350 Unable to transfer data. Name buffer full.
Cannot maintain the buffer required for transferring data.
- 351 File operation was interrupted by system call.
The lpr driver received a signal from the system, which interrupted an open, read, or write operation.

If You Have A Problem
If Errors Occur

- 352** Network is down after receiving a reset.
The network is down after receiving a reset. Try again after network recovers.
- 353** Network is down. No response from server.
Network is down. There in no response from the server.
- 354** Operation canceled.
Operation canceled by user. For example, an abort command was sent.
- 355** Cannot create file/dir. Change permission.
Write permission is not set for the directory where you are trying to create a file or subdirectory.
- 357** Unable to go to the dir. Permission denied.
Network File System server cannot move to the specified directory. To access the directory, change the permissions.
- 358** Select UPDATE/ADD to update/add printer setup.
To update or add your new or modified network printer setup, the UPDATE or ADD secondary softkey must be selected after finishing the initial setup.
- 363** Duplicate file names exist.
The same file name cannot be used for multiple files.
- 364** No such file or directory.
The Network File System cannot find the specified file or directory.
- 365** Unable to read or write to directory.
A file read or write operation cannot be performed in the specified directory.
- 366** Invalid argument. Check command syntax.
Specified argument did not work when executing the command. Verify the command syntax and argument are correct.
- 367** Seek operation failed.
Seek for file operation failed, or append write failed to open the specified file.

If You Have A Problem
If Errors Occur

- 368 NFS Software caused connection abort.
Network file system (NFS) was disconnected. Verify the NFS server is operating correctly.
- 369 Connection reset by peer. Remote disconnected.
Remote connection was terminated. Verify the remote setup and the executed operation are correct. Verify the local and remote systems are operating properly.
- 370 Unable to transfer data. Communication down.
Data cannot be transferred because the communication was shutdown.
- 371 NFS Connection refused.
Connection to NFS was refused. Verify the refused device was properly exported.
- 372 Connection failed. Socket was not sent.
NFS Connection failed because the socket was not sent.
- 373 Too many levels of symbolic links.
The file is linked to itself, or the linked file is linked back to the file.
- 375 Cross-device link.
Unable to hard link different physical file systems. Hard link must be done to same file system.
- 377 Unable to use this protocol.
Unable to use this protocol on the network.
- 378 This protocol is not supported.
This protocol is not supported on the network.
- 381 This type of protocol is not supported.
This type of protocol is not supported on the network.
- 383 NFS too many references, can't splice.
- 386 System busy. Saving/getting text files.
The 4155B/4156B cannot be interrupted by other operations. For example, text files cannot be saved or retrieved while making measurements.

If You Have A Problem
If Errors Occur

- 387 Unable to access file. The file is locked.
 Unable to write to this file. The file is locked by another
 process.
- 388 No such device or address.
 The 4155B/4156B cannot find the specified network device or
 address. Verify the correct device file exists, the select
 code/major number/minor number are correct, and that the
 device is correctly connected (high speed or low speed port).
- 389 System busy. File operation is in progress.
 File operation is in progress. During a file operation, the
 4155B/4156B cannot perform other operations, such as making
 measurements, changing setup fields, printing and so forth.
- 391 Network printer connection time out.
 A time out occurred when connecting the network printer to the
 print server or NFS server.
- 392 Network File System server is down.
 Server for the Network File System is down. Contact your
 network system administrator.
- 393 Communication to desired server failed.
 Communication to desired server failed.
- 394 System busy. Mounting device.
 When mounting a device, the 4155B/4156B cannot be
 interrupted by another operation, such as making a
 measurement.
- 400 System bug. Undefined method.
- 401 System bug. Invalid parameter.
- 402 System bug. Inconsistency.
- 410 Unable to display. Number must be <10001.
 Unable to display the measurement results because the data size
 of the result is too large. The number of the measurement
 results must be less than 10001.
- 411 Connection failed. Set Destination
 address.
 Network connection to destination failed. Verify the destination
 address is set correctly.
- 412 Address family not supported.
 Specified address family is not supported for the currently used
 socket.

If You Have A Problem
If Errors Occur

If a Measurement Data Status is Displayed

If measurement or stress force cannot be performed correctly, the measurement data status is displayed at the bottom of the GRAPHICS, LIST, KNOB SWEEP, or STRESS FORCE screen. The status indicates hardware and calculation errors.

The status format depends on the displayed screen as follows:

GRAPH/LIST: GRAPHICS and KNOB SWEEP screen

Status is displayed in following format:

STATUS: *AB AB AB (A A A A A A A C)*

- *AB AB AB* is for X, Y1, and Y2 axis respectively. No Y2 for KNOB SWEEP.
- *A A A A A A A C* is for SMU1 to SMU6, VMU1, VMU2, and PGU1/2 respectively.

Where, *A*, *B*, and *C* mean as follows:

- A** hardware status error. If multiple errors occur, numbers are added and displayed as a hexadecimal number.
- 1 : AD converter overflow.
 - 2 : Oscillation
 - 4 : Other channel reached compliance limit.
 - 8 : This channel reached compliance limit.
- B** data error. If multiple errors occur, numbers are added and displayed as a hexadecimal number.
- 1 : stack register overflow
 - 2 : calculation error
 - 4 : only one data for delta measurement. At least 2 data needed.
- C** PGU status
- 1 : PGU average output current exceeds 100 mA.

For non-measurement channels, "_" is displayed.

If You Have A Problem
If Errors Occur

GRAPH/LIST: LIST screen

Status on GRAPH/LIST: LIST screen is displayed in following format:

STATUS : *AB AB AB AB AB AB AB AB* (*A A A A A A A C*)

- *AB AB AB AB AB AB AB AB* is for the up to 8 LIST variables that can be set up.
- *A A A A A A A C* is for SMU1 to SMU6, VMU1, VMU2, and PGU1/2 respectively.

Where, *A*, *B*, and *C* mean as follows:

A hardware status error. If multiple errors occur, numbers are added and displayed as a hexadecimal number.

- 1 : AD converter overflow.
- 2 : Oscillation
- 4 : Other channel reached compliance limit.
- 8 : This channel reached compliance limit.

B data error. If multiple errors occur, numbers are added and displayed as a hexadecimal number.

- 1 : stack register overflow
- 2 : calculation error
- 4 : only one data for delta measurement. At least 2 data needed.

C PGU status

- 1 : PGU average output current exceeds 100 mA.

For non-measurement channels, "_" is displayed.

If You Have A Problem
If Errors Occur

STRESS: STRESS FORCE screen

Status on STRESS: STRESS FORCE screen is displayed in following format:

STATUS: *A C*

Where, *A* and *C* mean as follows:

- A* hardware status error. If multiple errors occur, numbers are added and displayed as a hexadecimal number.
- 2 : Oscillation.
 - 4 : Some channel has reached compliance limit.
- C* PGU status
- 1 : PGU average current exceeds 100 mA.